

Deero



Live Action Role-Playing



rulebook[®]

The NERO® Rule Book© 9th Edition is dedicated to Fran Moore,
who passed away in October of 2010. Fran was one of the most prominent writers of the Tyrran Campaign, she and
several others shaping the Tyrran World as we know it today. Fran was and continues to be, an inspiration to us all.
~ Joseph Valenti

The NERO Rule Book is © 1990, 1991, 1992, 1993, 1994, 1997, 1999, 2011
by Nero® Live Adventures Games LLC.

The NERO name and logo is a registered trademark of Nero® Live Adventures Games LLC.
This book is for use in official NERO games only.

Use of these rules by purchaser in any unsanctioned game where admission is charged is prohibited.
No part of this book may be reproduced, stored in or introduced into a retrieval system or transmitted, in whole
or in part, by any means (electronic, mechanical, photocopying, recording, or otherwise) without expressed
written permission of NERO.

Purchase of this book implies acceptance of the above terms.

Joseph Valenti DBA NERO
653 Country Kitchen road
Barnesville GA 30204
(914) 309 - 7718
Jvalenti@nerolarp.com
www.nerolarp.com

NERO



Live Action Role-Playing



Nero Rule Book[©] 9th Edition

Edited and Compiled by:

Melissa Brannon, Dan Comstock, Tim DeLong,
Nicholas Denny, Mike Ennis, David Epstein,
Michael Golosovker, Tiny Hughes, Rebecca King,
Noah Mason, Ryan Massey, Mitchell Meconi,
Robert Poulin, Matthew Sims, Charles Smith,
Kevin Sterbakov, Joseph Valenti, Fred Watson, John
Zeigler, Sarah Clark, and many, many others

Lead Photographers: Joanna Becker

Contributing Photographers:

Scott Erb Photography, George Short, Damien Turi,
Erin Nicholson, Sarah Clark, Ivey Hardy, Brian
Wamsler, Denise Beucler, Rebecca Kindergan, Angel
Williamson, Tony Lopes, NorthCoastNero, Sheena
Osborne, David Acosta

Designers:

Adam Taylor, Heidi Morris-Taylor

Special thanks

To Sonya Maizell for writing the introductory story

The NERO[®] Game System[®] is intended to allow players and staff hours of live-action fun without any amount of play stoppage. It is the responsibility of the players and staff to remember this when reading and interpreting the rules. We have done our best to clear up vagaries and make these rules sound, and we will continue to do so in the future. Still, players and staff should avoid constantly trying to find loopholes or language that allows them to do things that are against the spirit of the rules. The NERO International Office will determine the spirit of the rules in all cases where interpretation is disputed.

TABLE OF CONTENTS

I. Getting Started	3	VI. Game Play	83
Introduction	4	Combat	84
How NERO Works	5	<i>Delivery Methods</i>	87
The 4 Most Important Rules	5	<i>Effects Types</i>	87
An Introduction to the Rules	6	<i>Calling Weapon Damage</i>	87
Your First Weekend	6	Special Abilities	90
Play Testing Rules	9	So You Want to Be a Thief?	94
Be a Successful Nero Player	9	Traps & Locks	96
		<i>Trap Types</i>	96
		<i>Trap Mechanics</i>	97
II. The Basics	11	Marshals	99
Classes	12	Cheating and Metagaming	99
<i>Fighter</i>	12	NERO Sportsmanship Policy	100
<i>Rogue</i>	12	Code of Conduct	100
<i>Scholar</i>	12	Safety	101
<i>Templar</i>	12	Quick Start Character Gen.	102
Races	13		
<i>Barbarian</i>	15	VII. Adventuring Gear	103
<i>Biata</i>	15	Physical Representations	105
<i>Drae</i>	16	Armor	105
<i>Dwarf</i>	16	Weapons	106
<i>Elf</i>	17	Weapon Construction	108
<i>Gypsy</i>	18	<i>Weapon Safety Guidelines</i>	110
<i>Half Ogre</i>	18	<i>Materials used in the construction</i>	111
<i>Half Orc</i>	19	<i>How to Make a Weapon</i>	112
<i>Hobling</i>	19	<i>Maintaining Your NERO Weapon</i>	114
<i>Mystic Wood Elf</i>	20	Shields	114
<i>Sarr</i>	20	Potions	114
<i>Scavenger</i>	21	Scrolls	115
Cultures	21	Alchemy	115
Monsters & NPCs	21	<i>Types of Alchemical Substances</i>	115
Matters of Life and Death	22	<i>Elixirs</i>	115
Character Advancement	26	<i>Alchemical Substances</i>	116
		VIII. Atmosphere	119
III. The Skill System	27	Role-playing	120
The Skill System	28	Anachronisms	122
Spell Slots	28	The Society of NERO	124
Skill Costs	29	Medieval Society	125
Production Skills	32		
Skill Descriptions	33	IX. Index	129
IV. Magic	45		
Magic Section	46		
Formal Magic Overview	49		
<i>Common Formal magic Spells</i>	49		
<i>Formal Magic Components</i>	50		
<i>Extended Circles of Power</i>	50		
<i>Magic Items</i>	51		
<i>Definition of Basic Terms</i>	52		
<i>Special Types of Formal magic</i>	53		
<i>Casting Rules</i>	55		
<i>Casting Walkthrough</i>	57		
Cantrips Overview	59		
V. Spells	61		
Spells	62		



getting started

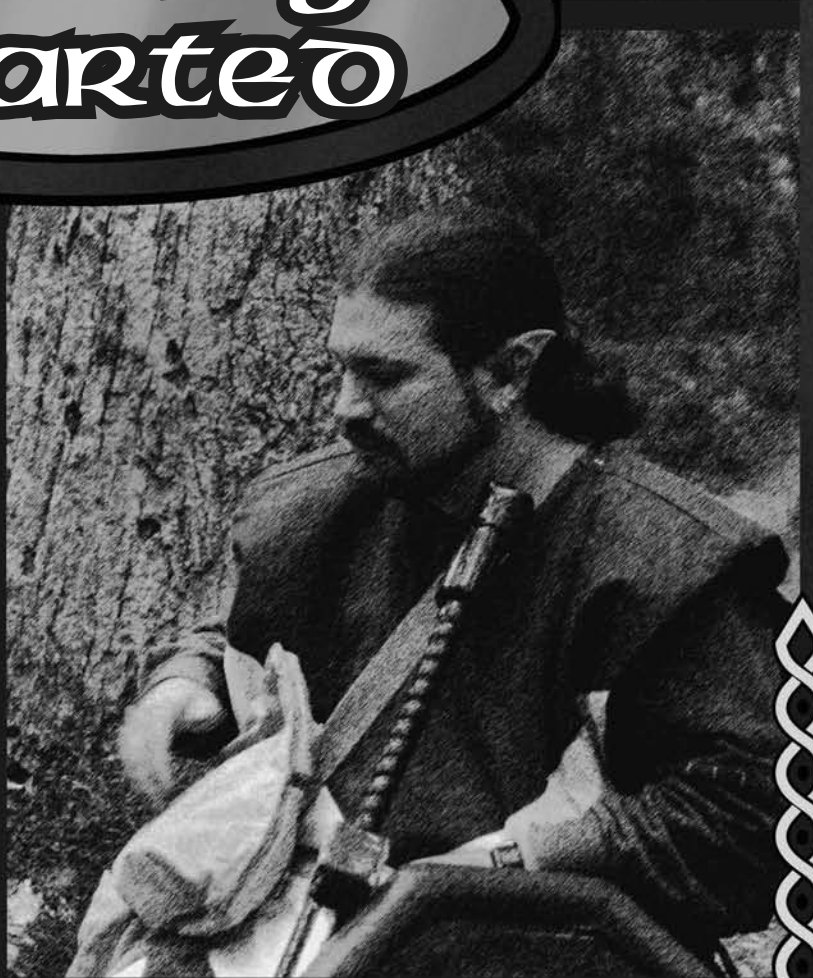



Introduction

Call upon chaos to create undead! Arise, my minions! Arise and slay them all!" The voice of the necromancer echoed like a funeral song through the cave, bouncing off the walls and ringing in our ears. We could not see her beyond the flickering light of our torch, and at first it seemed as though nothing had happened. I exchanged a few glances with my companions but found little confidence in their nervous expressions. Tightening my grip on my sword and drawing my shield closer to my chest, I strained my eyes to see into the pitch-black tunnel before me. Slowly, as though the noise was being dredged up from the heart of the cave, the soft sound of feet dragging along gravel and rocks being scratched sifted into our ears. I looked at my companions and saw looks of dismayed realization cross over their faces. The necromancer's spell had worked.

Too cowardly to handle us herself she had desecrated the bodies of the dead and reanimated them to serve her. If we had known any of these people in life, they were unrecognizable now. As they lurched slowly into the circle of light around us I heard a few of my comrades gasp in horror at their appearances, and I could hardly blame them. Decayed flesh hung off the bones of the undead, displaying their ivory white bones and the remains of their innards. Though their eyes had rotted away long ago they still seemed to see us through their empty sockets.

Gritting my teeth, I stepped forward, determined to get rid of these monsters. The undead nearest to me swung a stone mace at my chest, but I blocked it deftly with my shield and hacked him in two with a swipe of my sword. Undead were not difficult opponents, their brains are too rotted and maggot-ridden to direct their actions, but that was not what made them such terrifying opponents. While there were only a small handful of us in the cave, the undead could be as numerous as the necromancer desired. She only had to animate more of the corpses

she had dredged up and send them in our direction. It was unlikely a single undead would fell one of us in combat, but a horde of them could overwhelm our party in no time.

I tried to conserve my energy, for the darkness hid just how many she had sent to assault us. Beside me my friends were doing the same, but it was clear we could not fight forever. The undead moved with uneven steps toward us with the tireless energy of the afterlife. I suddenly froze as I heard someone cry out in pain. Peering around wildly, I saw that one of the undead had managed to latch its claws into the left arm of our rogue, Ivan. He managed to fight it off before it did him any more harm, but it was clear his arm was too mangled to be of any use now.

"Don't worry, I'll take care of him." Erin, our healer, said before she swept quickly over to Ivan, who was cradling his arm unhappily against his chest. I had no time to thank her, for without Ivan holding one end of the line the undead were beginning to push us back. I managed to cut several more to pieces before one with a significant amount of muscle left undecayed on its form shoved me to the ground. My weapon clattered loudly onto the stone floor beside me and as I looked from it to my opponent I could see there would be no time to recover it before the undead would be upon me.

"I call forth a flame bolt 20!" Shouted Kryssa, our celestial scholar, and I found myself sighing quietly with relief as the undead leering over me was incinerated by her spell. The stream of fire illuminated the cave briefly as it left her hands and I glimpsed a pale face glaring hatefully at me from across the room. As the room faded to darkness once more I was suddenly grasped with comprehension. It was the necromancer!

"She's here, only a few yards away!" I cried, grabbing my sword and leaping to my feet. The sound of footsteps announced the necromancer had heard my call and, alarmed, began to flee. Determined not to let her escape I attacked her small army with renewed vigor. Anything my blade did not manage to slice in two was swiftly turned

to ash by Kryssa's magic. Soon the undead lay at our feet, at peace once more. I lunged forward to pursue the cause of this mess but felt a hand firmly grasping my upper arm. Irritated, I swung around and found Kryssa holding onto me.

"We can't leave those two behind," She said, nodding at the other end of the tunnel, where Erin was still tending carefully to Ivan's wound. "We wiped out everything she tried to throw at us," the woman added reassuringly, "She won't be coming back to bother the people around here again, because she knows we'll be here waiting." Still eager to chase down our foe, but seeing the sense in her words, I nodded and began to walk back to our other two comrades. The necromancer had escaped, but we were confident this was one village she would never torment again.

Where fantasy becomes a reality...

NERO, an acronym that stands for the New England Role-playing Organization, allows you to play a character in a live action fantasy adventure. Under NERO's unique rule system, people gather to populate an entire fantasy medieval town.

In the NERO game, you create a character concept for a fantasy story and actually play the character. It is much like improvisational theater in that you have a framework created by the props and supporting characters and must develop your part as you progress through the storyline. Your character's attitudes, ambitions, and history are yours to define.

If the adventurous life is your calling, you may play the part of a wanderer, meeting with some friends in the tavern. While swapping tales, your party could get hired by a poor farmer in desperate straits, and spend the afternoon slaying a foul necromancer and his undead abominations.

If the epic life is not your style, then you can play the part of a town merchant. You can make your money selling your wares and information for the right price.

Or perhaps you wish to be one who investigates the magical arts, selling your scrolls and potions to earn the money you need to continue your studies.

Or would you rather try to become the leader of the Mages' Guild? The choice is yours.

NERO is dedicated to the legendary days of high fantasy, while running a fun (and above all safe) game. We have fierce warriors, crafty scouts, powerful mages, loyal knights, and benevolent healers. There are smelly goblins, blood-chilling specters, evil necromancers, and villainous spies to fight, and your very own legends to create.

How NERO Works

In NERO, a cast of non-player characters (NPCs) are used to set the tone and provide background for the player characters (PCs). They may serve important town functions (such as Guild leaders or high ranking nobility), but their primary purpose is to help propel the plot and action. Much of what happens at an event, however, is completely decided by the players.

NERO uses padded weapons to simulate actual combat, and a magic system that uses packets made of fabric and bird seed to represent the hurling of spells. Mock (and sometimes real) armor and other costumes are used to enhance the atmosphere.

There are many types of NERO events. The most common are day events, weekend events, and long events. Each type of event runs non-stop from start to completion. Day events start and end on the same day and may last for 8 or more hours. A day event is usually composed of a single scenario (module) and may be very linear in nature. Weekend events run from Friday night to Sunday morning/afternoon. Long events are any event that runs longer than a weekend event. The most common long event lasts for 4 days (Friday to Monday), but it is not unheard of for a long event to last for 9 or more consecutive days. Weekend and long events are composed of collections of modules with multiple plot-lines and bring to life a medieval town with all its inhabitants and intrigues. There is nothing to compare with the feeling of playing for 24 hours a day along with possibly hundreds of other players, each with their own desires, fears, and aspirations.

It sounds simple, but when you are in the middle of a dungeon with shadowy shapes moving towards you in the darkness and strange sounds echoing down the halls, trying to remember what that fellow in the tavern said a half hour ago about how to get through this infernal door, your perspective on the difficulty of the situation may change.

As you play your character, you will gain abilities and influence, and may one day gain a noble title or great fame and wealth. Tales of your adventures may someday be sung by bards, or retold time and again by storytellers sitting by the fire with a cup of spiced cider.

What your character does is entirely up to you. You decide what you want and where you want to be. The future is yours to define and create.

The 4 Most Important Rules

This book has many rules and requirements and for new players it can sometimes be overwhelming. There are some rules that are much more important than the others. The rules listed below are required for NERO to continue to be a safe game, and there are no exceptions to these rules—they apply to all players and NPCs. Breaking these rules may require your removal from the game.

The Body Contact Rule

NERO prohibits all body contact during combat. All combat must take place with NERO approved safe weapons, and certain parts of the body (head, groin, hands) are not allowed to be hit, even with these NERO safe weapons. This rule does not apply to packet delivered attacks, which may hit any part of the body.

The Alcohol Rule

NERO absolutely forbids alcohol and illegal drugs at its events, and you are not permitted to use these off site and then come to the game drunk or high.

The Hold Rule

If you hear someone yell "Hold!" stop everything you are doing and drop to one knee. Holds should only be called if there is a real need, and usually only for safety reasons. You cannot call a hold to check on a rule, or ask if someone knows that you hit them with a spell or ability, unless that rule or effect is so integral

to the situation that it would affect every person involved in that situation.

The Sneaking Rule

If you wish to sneak into a building or tent (regardless of whether you are sleeping in that building or tent for the event), you must have a marshal present. This rule helps ensure that out-of-game items (the personal property of other players) are not accidentally taken if your character chooses to steal items from another player's building or tent.

Please follow these rules completely and report anyone who does not to a marshal.

An Introduction to the Rules

A lot of what you will read in the upcoming pages may be confusing; there seems to be a lot of rules, and some rules rely on other rules to a degree that understanding one is not possible until you understand the other—but how can you do both at the same time? Don't be discouraged. It's really a lot easier than it seems. There is also a quick character generation guide at the back of the book.

A basic overview to get you started:

You, the player, will portray a character for the duration of the event. Your character has certain skills. Some of these are usable whenever you'd like (such as your skill in a specific weapon) and some are usable a limited number of times per day (like the ability to cast a spell). In order to learn more skills, or to be able to cast a large number of spells per day, you will have to gain experience.

You gain experience by attending events. The amount of experience you earn is based on whether you PC or NPC. If you PC you will receive a base amount of experience that you can then double in a number of different ways. You may turn in game money at the end of the event, perform a number of hours of NPC duty (if the chapter allows this), or the chapter may grant all PCs double experience just for attending the event. If you NPC the entire event you will receive the maximum possible amount of experience as a reward for your service.

Awarded Experience Points (XP) are then transferred into Build Points (BP). Build Points are what you use to buy new skills. Every 10 BP you earn increases your level. The amount of XP needed to earn a new Build Point increase each time your level increases, so the higher level you become, the slower you gain new skills.

Your character must be one of the currently allowed races, such as Human, Elf, Dwarf, or Sarr. For a complete list of races and their

advantages and disadvantages, see the Classes and Races section in this rule book.

Your character also has a specific class which determines the number of BP that a skill will cost, the total number of Armor Points you can wear to start, and the number of body points that you gain per level.

Sometimes you will get into battles. When swinging a weapon, you will call out the amount of damage your weapon will do.

A standard long sword does 2 points of damage. When you get hit, you will subtract from your Armor Points and your Body Points until you are at zero or below. Your opponent will do the same. Spells may be cast during battles and they can affect the battle in many ways. You need to know the spells in order to get the most out of your NERO experience. Spells are represented by foam golf or tennis balls purchasable at most sporting good stores, or small cloth packets filled with birdseed that you can make yourself. You must say the specific words (incantation) associated with the spell (such as "With mystic force I web you!") and hit your target with the spell aura for the spell to work.

You may have tags or a character skill sheet which you use to keep track of your current Body Points, Armor Points, skills and spells. After each battle, you and your opponents must adjust the tags to keep track of your new status.

Now let's look at a typical NERO weekend and see how some of these rules are applied.



Your First Weekend

Here's an example of a typical NERO weekend as experienced by a new player (You!):

Once you have your character established, you check in for a NERO event. You are given a small amount of starting money tags representing your starting equipment and a character card which lists your current skills and other pertinent information. You will get a new card for every event in order to keep this information accurate and up to date. This allows you, other characters, and the game marshals to keep track of your abilities should any disputes arise. You will also receive either tags for each of your abilities or a character skill sheet.

You also have to get your weapon checked. Even players who attend every event must get their weapons checked each time. If your weapon is approved, you are given a safety tag that is attached to your weapon.

If you do not have one already, you are given a cabin assignment. Once you have finished checking in to the event, you put on a white headband (signifying that you are out-of-game) and carry your bedding and other equipment to your room. You are then ready to get into your costume.

One thing you notice is that everyone in the NERO game wears a costume. The type of clothes you wear can also help with your Armor Points. If your costume looks like it fits the IG atmosphere you will be able to wear more armor.

The time that game begins will vary based on the chapter and

the length of the event, but all weekend and longer events typically start between 9 pm and 11 pm Friday night. Prior to the start of game will be opening ceremonies where the weekend coordinators go over the chapter's policies, camp rules, and any plot information that would be known by all characters.

It's Friday night and the town is buzzing. Guilds are having meetings, adventuring groups are planning strategy, the elves are having a ceremony, and the tavern is packed. Rumors of a zombie attack are floating about and the political situation doesn't look too secure. Life could be easier—but it could also be boring. You adjust your boots, make sure your dagger is handy, and start walking at a leisurely pace over to the tavern, but only get a few steps before something jumps out at you. It's a goblin! You can tell by the ugly green face.

Goblins and other monsters are some of the Non-Player Characters in NERO. Members who want to play monsters get special benefits for that event but must do what the chapter hosting the event tells them.

The goblin advances and swings his sword. You pull out your trusty dagger.

Weapons in NERO are soft "boffer" weapons. They are basically PVC piping covered with foam rubber, with very soft ends. Injuries are very rare occurrences at NERO events—a game of little league baseball is more dangerous than a NERO combat. Players in NERO buy their equipment and weapons though we also provide instructions for making them.

A dagger only does one point of damage while a long sword (which the goblin has) does two. The goblin knows this and smiles (or at least you think he does behind his goblin mask). What the goblin doesn't know is that one of the skills you bought with your Build Points is a *CRITICAL ATTACK* which allows you to do an extra point of damage.

The battle begins. Each of you calls out what damage you are doing so the other player can keep track. "Two Normal!" yells the goblin. "Two Normal!" you reply, using your Critical Attack in the hopes of finishing off the goblin before he finishes you!

The goblin lunges at your chest, but you jump aside just at the last moment! As he passes by, you jab at his back with your dagger.

"Ow!" screams the goblin. "Dat hurt! Me no like you!"

You grin and swing out again, just to tease and torment the creature. He advances. "Me now teach you lesson!"

With a lightning quick thrust, he swings at your chest. You try to block with your dagger, but fail to bring your weapon up in time to block the attack... Your now ruined shirt tells you that it might be a good idea to be a bit more careful with this foe.

You make a mental note to find someone to teach you how to fight with a long sword as soon as possible.

You now have both taken two points of damage. Since you've never fought a goblin before, you don't know how many total points he has. Will the next hit bring him down?

"Give up, smelly human?"

"Never!" you reply, jumping in and taking the foul creature by surprise. His yelp of pain as your dagger slices his chest is very satisfying. . .but he's still up!

Perhaps running away might be a good option.

The goblin senses your apprehension and follows with a flurry of attacks. You are able to block most of them, but one lands its target, cutting through your torn shirt and releasing a spray of blood. The goblin laughs triumphantly.

That does it! This really sparks your anger and you lunge in like a mad man, hacking away at the green-skinned creature. This is more than he can take, and he falls to the ground.



You stand there breathing heavily for a minute, and then you lean over him and search him.

"I search you," you say. He hands you three silver pieces and a strange locked box he had on him.

Now that the fight is over you must mark (by removing tags or marking your character skill sheet) that you've used a critical attack, and that you have taken four points of damage. You only have four Body Points left! Better find some healing before your next encounter.

If you die either in battle or by execution, your character can then be resurrected. See the section of the rule book dealing with Death for more information on what happens when your character dies.

You walk into the bustling tavern. Some local bards are playing quietly in a corner. As you look around the tavern you are surprised to see the local Baron himself, sitting with the Magistrate and the Sheriff! They seem to be arguing over something and it must be important given how many other people are sitting nearby trying to pretend they're not listening.

You find a spot and sit. The gypsy tavern keeper dances over to you and brings you a drink for a silver piece.

A woman sits nearby and pulls out a book and begins reading, by the glow of her hands, you can tell that she is a spell caster. You walk over.

"Good evening," you say. "Might you be a healer?"

"Yes I am," she replies. "I am Arcadia. Are you in need of help?"

You tell her about your encounter with the goblin and ask if she can spare a CURE LIGHT WOUNDS spell. She states that such a spell would cost three silver pieces.

"I only have two," you reply, showing her your meager wealth.

She glances at you and sighs. "Very well," she says. "I have to make a living, but I took an oath to help those in need. I will cure you, but you will owe me a favor in the future!"

"Agreed," you reply, handing her the coins. She calls up her power and touches your shoulder.

"I call upon the earth to cure light wounds 5" she says.

A burst of warmth fills your body and you can feel the wound healing itself.

You then have to adjust tags or mark your character skill sheet to reflect the fact that you have been healed and your missing body points have been restored.

A warrior in chain mail then comes up to both of you. With her are a venerable mage and a rather shifty-looking individual.

"Pardon me," she states, "but we were just wondering if you've heard anything about a goblin treasure map. We'd be willing to pay for information that proves to be true." You try not to show any reaction as she speaks about a rumor she had heard involving a map kept in a small box. Better find out more about these people before making any commitments.

You introduce yourself and they do as well, and you all spend some time discussing your pasts and talking about other rumors and bits of decide information you have

heard. You finally decide that they can be trusted and you suggest that you all go someplace where no one can overhear.

You travel to the mage's cabin where you show the box to the shifty-eyed person, who turns out to be a "locksmith." He smiles at the challenge and pulls out his tools.

In the world of NERO, real locks are used. Buying the required *PICK LOCKS* skill does not guarantee success; it only allows you to make the attempt at picking the lock. Likewise, boxes are really trapped with electronic buzzers or other noisemakers. To check for traps you must actually check the object for traps by carefully examining the object without accidentally setting off a trap you have not yet detected. Once you know a trap is present, you can then try to disarm or bypass the trap if you have the skill *DISARM/ARM TRAP*.

Depending on the state where a chapter is located, it may be against the law for you to possess any tools designed to pick a lock. In this case, the local chapter will use the Alternate Pick Locks rule, as described in the entry for the Pick Locks skill.

The rogue picks the lock. Inside the box he finds a strange amulet, some coins, and a map written in a strange language!

Tomorrow you will go to the Merchants' Guild to have your amulet appraised for its value. You will also go to the Mages' Guild and have it checked to see if it's magic! However, you and your new companions spend most of the night decoding the map. Outside, you can hear the sounds of battle as a lich has called forth his undead to destroy as much of the town as possible. You decide that the knights can handle it and wisely stay inside.

After you decode the map, you find the small note at the bottom which says

"See a marshal when you're ready to go on this adventure." You decide to rest for the night and start in the morning and you head to bed with visions of treasure and future adventures in your head!

This is one way that a group may get into a weekend adventure module. Some modules are repeating in that more than one group can go through at different times, while others are one time only. The one time only modules may be major affairs, and can affect the whole storyline, or they may be modules that simply cannot be repeated (saving a coastal town from a ghost ship). You can see that a NERO adventure is like no other—the possibilities are endless for creative players. So welcome to NERO, where you can be all that you *can't* be!

Multiple Characters

Unless you are NPC'ing, you cannot play more than one character during an event (unless your character dies permanently and you start a new one). It is too confusing to other players – they will think you are playing the same PC but wearing different clothes. When you create a second character, please have that character be as different from your original character as possible: your new character should have a different adventuring party, different costume, and hopefully be of a different race and class as well. Multiple characters belonging to the same player may never directly interact in any way.



Play Testing Rules

Each NERO chapter abides by the rules listed in this book. Additionally, these rules can be modified and new rules added by official NERO play tests. The NERO International Office makes available an official list of rules that are being play tested on their website www.nerolarp.com. Each chapter must make available a list of the play tests that they are using, so that players attending events at a chapter can find out ahead of time which play tests will be in use.

Be a Successful Nero Player

Creating a believable and fun character history is a significant key to enjoying a NERO event. Knowing your character's persona can give you wide reaching role-playing possibilities. Written character histories are not required to play NERO but they will provide you with background and us with opportunities to give you plot.

Once your history is finished, it should be submitted to your local Plot Committee for approval. They will use it to make your adventuring more interesting by tying your history into what you are doing now.

Understand, however, that the committee has the right to overrule your choices if they would violate game rules or give your character too much of an advantage in the game. After all, you can't just say that you're the son of a famous king with superhuman abilities and a million gold pieces and expect us to allow it.

Avoid the clichés common in so many fantasy films and literature. And that includes thinking of a name for your character. Although we have yet to see a Conan or a Bilbo Baggins, we have had our share of Vlad Taltos, Rand al'Thors, Belgarions, Elrics, and Skeeves. What, do you think you're the only person in the world to have read these books?

Be creative in your ideas and your presentation! Some players have written their character histories as letters to family, interviews or even once a confession after being caught stealing, explaining why the person was a thief! Use your imagination!

Here is an example of an unimaginative (and all too common) character history. Please do not send us something that reads like this:

My name is Deathbringer Bloodblade Darkshadow. My father was a Count and my mother was the heir to the throne of the Elven Kingdom.

When I was but a baby, my parents were killed by a marauding group of bandits from Rotaria who left me and my twin brother to die. They captured my beautiful sister and sold her to Eastern barbarians where she now serves in the harem of their evil leader Konad. My brother was later kidnapped by gypsies and I had to fend for myself. I proved my worth and strength at an early age when I killed an armed troll with my bare hands.

I taught myself to be the best swordsman in the kingdom. However, I keep my abilities secret as I do not wish for my enemies to find me.

I now travel mysteriously from town to town, dressed all in black. I appear without a sound and disappear as a mere shadow flicking through the night. When I enter the tavern, the crowd grows silent as I sit alone in the corner with my back to the wall.

I do not have many friends but I do have the respect of all. Although I do not seek permanent female companionship, I secretly enjoy the lavish attention that the women give me.

I search for my long-lost brother who I know can help me regain my birthright, rescue my sister and wreak my vengeance against any Rotarian I come across. I will be able to recognize him and my sister by our distinctive family birthmark—a scarlet rose on our left elbow.

Oh yeah, I am also searching for my father's sword Dooblade which will only work for members of my family. This sword was created by the finest dwarven craftsmen specifically for my father after he single-handedly saved the dwarven kingdom from the attacking hordes of mountain trolls and death elementals that once plagued the peaceful people. This sword allows me to double any proficiencies I may already have (Plot committee: Can I have this?).

Although I have often been asked to join with other adventuring groups, I keep to myself and to mine own self I am true. I do adventure from time to time when the cause is worthy.

There are lots of problems with this history - first of all, it contains every hackneyed cliché overused in bad literature of this type. One or two may have been acceptable, but this is ridiculous. (And who names their kids Deathbringer Bloodblade Darkshadow, anyway?) Secondly, and perhaps more importantly, if this person has done all of these great heroic things, then why in the world is he entering our game as a lowly second level character?

Most character histories that are rejected fail because of that reason. Players write histories naming themselves as great heroes who can cast amazing spells and have written great learned treatises or have killed great monsters, but as a starting player in our game, they can't afford to buy *READ AND WRITE* or *WEAPON PROFICIENCIES*. What, did your character forget everything all of a sudden?

A well fleshed-out and detailed character history need not be filled with adventure and excitement. Its primary purpose should be to establish your character's personality - why does your character act and feel the way he or she does?

Think about your own life as a guideline. What is it in your past that has made you what you are today? What is your family like? Your schooling? Your friends? The types of places you have lived? Your jobs? After all, every experience you have shapes your personality.

Here is an example of a good character history:

My name is Trin Hallison. I am the eldest son of Lorin and Frinda Hallison. I have two younger brothers and two older sisters. I was born in the mining city of Ironvale in the duchy of Ravenholt in the kingdom of Evendarr in 576. My father was the head cook of one of the mines in the area and my mother worked in the payroll department. They held different shifts so that at different times I was raised by both my father and my mother.

My father had served in the army of Westmarch under Goodwyn Northridge as a short swordsman I have many fine memories of afternoons spent with my father practicing sparring - I never could beat him! (I could, however, beat my younger brothers and sisters, and I gained even more experience playing with them). My mother knew a few healing spells which came in handy when we kids hurt ourselves in our games. She tried to teach us to read and write, but only my sister Burra took an interest.

At the young age of ten, while on a picnic with my family, I found a cave and began exploring. I soon was lost in the darkness and I was certain that every sound was a goblin or a troll out to get me. I spent a few hours crying in the darkness before I was discovered and ever since I have had a great fear of caves and extreme darkness even though I know my fears are unfounded. When Vandal Northridge became Baron of Westmarch, things changed a bit in Ironvale - the town guards became surlier and some of the nobles he appointed cared more for fattening their pockets than for the commoners whom they were supposed to be helping. I believe that all nobles in their hearts are the same even if they pretend to be caring. I would never work for nobility.

When I was old enough, I became apprenticed to a local cooper, making barrels for the town. It was boring work but it brought in the money my family needed. It was during this time that I became fascinated with magic, for next door to the coopers' was the local Healers' Guild.

The healers there noticed my interest in their activities, and one - a nice old lady named Hindy - often delighted me with her tales of adventures in Ashbury where she had fought many monsters in her younger days.

It was she who finally taught me how to perform first aid, and it was she who taught me my first spell.

My father died permanently when I was 14. It was a very traumatic experience for all of my family. He had died previously—a few times while in the army and once when a large boulder fell on him, but he had been successfully resurrected each time. This time he had a terrible disease, and the Healers' Guild could do nothing for him. I cried myself to sleep every night as he lay in bed in pain as the disease took over his body. Finally, I could take no more, and I placed a pillow over his head and held it down until he stopped breathing. I finally put him out of his misery. I have never told anyone of this and I feel very guilty about it. I made a vow to myself that I would never kill again, and that any enemy I would ever encounter would be captured if at all possible, and if dying would be first-aided.

When I turned 16, I felt that it was time to strike out on my own, and I decided to head to the area that Hindy had told me about. I decided to move to the big city where life is more exciting. I have now arrived in the city of Ashbury, where I hope soon to obtain a job and maybe - just maybe - find some adventure!

Notice how this history establishes a few character traits with which the player can have lots of fun—a dislike and mistrust of nobility, a fear of enclosed spaces and darkness, and a desire never to kill. Imagine the

complications in game when his views and desires run up against situations which require him to confront his fears.

This history also explains how he got the skills with which he will be entering the game: *ONE HANDED EDGED, HEALING ARTS, FIRST AID, READ AND WRITE*, and a spell.

If your character is older, you may have to think of a reason why your character is only second level. For example, perhaps you have been a farmer or a trapper for many years and now you have been kicked out of the family / evicted from your farm / mistreated by an evil bad guy / stirred into action by some injustice and now after all those years have decided to become an adventurer.

So go to it! Write an interesting character history and see how much more fun NERO will become.

Character Profile

Use these questions as a way to help “flesh out” your character history: Where and when were you born? Are you aware of your parent’s names? If so, what are they? What were their occupations? Do you know if they are alive or dead? If they are dead, how did they die?

Family: Do you have any siblings? Are you aware of them, and if so, how did you get along as children? Do you know where they are now, and if so, how do you get along now? Where are your siblings and what are they like?

Your Past: What was your childhood like? What were your parents’ childhoods like? Where, how, and from whom did you learn your trade?

Ambitions: What do you want out of life? What are your personal goals and ambitions? Is there anything about your life that you would change? What tempts you? Do you have any phobias? Do you have any superstitions?

Profession: Are you an adventurer, and if so, why? What would cause you to give up adventuring? Do you have any close friends? Do you have any enemies?

Opinions: What is your attitude about fighting and killing? How about mercenaries? What is your attitude about magic? How about mages? What do you think about necromancy? Do you think it is wrong to cast necromantic spells?

What is your attitude towards theft and thieves in general? How about someone in your group who steals? How about someone who steals from your group, especially if they are a member?

What is your opinion about Good and Evil? What is your attitude towards the law? How do you feel about nobility? What are your future plans?





the Basics



Classes



Classes are used to describe your character's natural talents. This may or may not have anything to do with your character's profession. For example, not all rogues are thieves and not all scholars are spell casters.

Your own physical characteristics and abilities need not match those of your chosen character but it can help you in your adventuring career if your actual physical skills are congruent with your character's fantasy skills. The NERO system allows players to play characters that are very different from themselves and still be able to prosper.

You must pick one of these classes:

Fighter

Fighters take naturally to the physical combat arts and rely mainly on strength and stamina to accomplish their goals. They can wear more armor than any other class.

Figure 2-1.



Rogue

Rogues have a natural bent towards dexterity based skills, and the practice of alchemy. Rogues are limited in how much armor they can wear. Their lower Body Points, lighter armor and relatively high costs for combat skills does not make them well suited for front line combat roles.

Figure 2-2.



Scholar

Scholars are adept at many mental skills and readily learn the magical arts. Scholars are even more limited in how many Armor Points they can use than Rogues.

Figure 2-3.



Templar

Templars are spell casters who are somewhat more adept than scholars at physical combat skills. They are not religious in any way; NERO specifically prohibits religion in the game. Their combat training leaves them better able to fight but takes away from their studies. They cannot use as many Armor Points as Fighters, but can use more than Scholars.

Figure 2-4.



Races

The human race is not the only race in the world of NERO. There are many mythical and unusual races, such as elves, dwarves, half-orcs, and other more exotic races. Some NERO chapters have sub-cultures of the listed races.

Only the races listed are available for play by PCs. Some NERO chapters have additional races or variations of the listed races but these additional races and variations are NPC only and are not available for use by Player Characters. In order to give the game a multiracial feel, each race has been developed individually to add to everyone's enjoyment. To keep the balance of each particular race, there are certain fundamental requirements that each player of that race must observe. We do this so that you will be placing yourself into a real culture that provides the most interaction with other players.

Racial abilities help you to understand a race's outlook on life. You must understand the necessities of role-playing your race based on the advantages and disadvantages of that race. You should purchase your particular racial abilities as soon as possible.

Playing your race means knowing and understanding your race's culture and society. Some races have their culture based on certain societies in our own world, some races are purely fantastic like the elves or hobblings and some are based on popular mythology or folklore. Other races such as the Biata have been created from scratch, creating a unique aspect to our game.

It is important to understand that this rule book only gives you a

brief description of your race's society. More detailed information on your race's culture can be found on the NERO International website www.nerolarp.com. It is very important that you learn the culture and behavior of your race so that you seem like a part of that culture.

If you wish to play a non-human race, you must wear the appropriate makeup to distinguish yourself. All exposed skin must be covered with the appropriate makeup. Any props (such as elf ears) must be worn at all times.

You cannot wear makeup to disguise yourself to appear as a race you are not, nor can you act in such a way as to mislead others as to your race. If you are not playing a barbarian or a gypsy, you cannot dress, talk and act like one.

NERO expects you to play your character's race properly. Half-orcs should be slow witted, barbarians should act uncouth, and drae should shun the sunlight. Even though we strongly encourage everyone to avoid clichés and stereotypes when creating their character histories, you **MUST** abide by your racial characteristics. You cannot write your history to make you the "outsider" of your race and be the one barbarian who is a genius celestial caster, the one gypsy who is quiet and shy, or the one drae who likes to go sunbathing.

A player not acting as described for his or her character's race will not be allowed to continue playing that character as a member of that race and will be forced to choose another race for their character. There is no such thing as true half races for purpose of NERO rules. There is nothing wrong with having your parents be of different races, but you can only take the attributes of one of these



Racial Comparison Chart

Table 2-1.

RACE	ADVANTAGES	DISADVANTAGES
Barbarian	+2 Body Points to Start Barbarian Slay: 10BP, once Detect Celestial Magic: 2BP	Double cost for Scholarly Skills see Table 3-2 on page 30
Biata	Break Charm: 2BP Resist Charm: 3BP Resist Sleep: 2BP	Cannot buy Read Magic
Drae	Resist Charm: 3BP Resist Sleep: 2BP Half Cost for Archery	-2 Body Points in the Day Cannot use Two Handed Sword Cannot use Two Handed Blunt
Dwarf	+1 Body Point to Start Resist Poison: 4BP -1 Cost for Smithing	Double cost for Read Magic Cannot use Polearm, Staff, Two Handed Blunt, Two Handed Sword
Elf	Resist Charm: 3BP Resist Sleep: 2BP Half Cost for Archery	-1 Body Point Cannot use Two Handed Sword Cannot use Two Handed Blunt
Gypsy	Gypsy Curse/Remove Gypsy Curse: 2BP	None
Half Ogre	+2 Body Points to start Strong arm: 10 BP, once	Double cost for Scholarly Skills see Table 3-2 on page 30
Half Orc	+2 Body Points to start Strong arm: 10 BP, once	Double cost for Scholarly Skills see Table 3-2 on page 30
Hobling	Resist Poison: 4BP Half cost for Pick Locks Half cost for Arm/Disarm Traps Hobling Dodge: 12 BP, once	-1 Body Point to Start Cannot be a fighter Cannot use two handed weapons
Human	None	None
Mystic Wood Elf	Break Charm: 2BP Resist Charm: 3BP -1 Cost for Craftsman	Must buy skill from Table 3-3 on page 30 at each level
Sarr	Resist Poison: 4BP Scenting Ability	Cannot use any blunt or any ranged weapons
Scavenger	Resist Poison: 4BP Scenting Ability	Double cost for Scholarly Skills see Table 3-2 on page 30

racers. In-game you can tell everyone you're "half-elf/half-gypsy" but out-of-game, you are one race or the other. You must then take all the advantages, disadvantages and physical characteristics of that single race and none of the unique characteristics of the other. No character may have the powers, physical characteristics, or mannerism of more than one race. It should always be very clear to everyone what race you are.

These role-playing rules are put in place to allow players to make assumptions about the races. When you see someone wearing pointed ears, you know that they may have certain abilities such as *RESIST SLEEP* and that may change your strategy with dealing with them.

You can conclude that every biata you see will dislike celestial magic and every dwarf will appreciate and study well-made weapons. Every race must act like and be identifiable as that race by all other players. By adhering to racial characteristics, this fantasy world of ours becomes much more real.

The following lists the basic NERO races (other than human). This is a very short overview. If you play one of these races, you can

find a more thorough explanation for your particular race that will provide more background for your character on the NeroLarp.com website.

The skills mentioned in the descriptions ahead are explained in greater detail in the "Skill Descriptions" on page 33. When reference is made to "Scholarly Skills" or "Stealth Skills," it means only those skills listed under those categories in the Skill cost tables. ("Scholarly Skills" for example includes *READ AND WRITE* and *READ MAGIC*.)

Note that if you are playing a nonhuman, you should buy your racial skills as soon as possible. After all, how can you possibly role-play your race properly if you don't have the basic skills and abilities that help to define that race? If you reach 5th level or so and still haven't purchased your skills, other members of your race should treat you as inferior or look at you with pity because you cannot resist sleep or break a charm.

The next section of this book lists the various races other than human. If playing a human, you are free to devise any sort of personality you wish without any benefits or disadvantages.



Barbarian

Barbarians come from nomadic tribes and are unused to “civilized” society. They are a very superstitious lot and may often perform unusual small ceremonies to rid themselves of their “curse.” (“Oh-oh! Seven hobblings just crossed path! Bad luck! Now I must tie string around finger and walk backwards for an hour!”) This is not to imply that barbarians have to be stupid—merely uncultured and somewhat primitive. In order to be identifiable as barbarians, you should talk poorly, dress in furs and leathers, and otherwise look primitive. Barbarian tribes (usually named after animals) are often very competitive and not too friendly.

Barbarian tribes are very earth friendly and in fact, celestial magic was unheard of by barbarians until the more “civilized” beings began moving into their area. As such, barbarians distrust celestial magic and consider it “not natural.” Barbarians fear and distrust celestial magic and will dislike having celestial protective spells cast upon them. This distrust only applies to Celestial Defensive spells, and does not apply to Celestial Magic Items. It should be noted that there are some characters that refuse to use Celestial Magic Items for role-play reasons of their own. This “Celestial Abstinence” is not required by the rules in any way. All players are encouraged to role-play their characters in any way that they consider fun.

When a barbarian reaches the age of 18, he or she will ask the tribe leader for a Task of Adulthood. This task must require an extreme amount of bravery and challenge and may take many years to accomplish. Only when the task is completed will the barbarian be considered a true member of the tribe. Barbarians who switch tribes are likewise required to perform such a task.

Barbarians are strong and thus start off with two extra body points. They have to pay double for all Scholarly skills. They can also buy the skills *BARBARIAN SLAY*, and *DETECT CELESTIAL MAGIC* which, once a day, will allow the barbarian to determine whether an item has any celestial magic present upon it.



Biata

According to legend, biata are descended from a barbarian tribe, but they do not act or look like barbarians. They have large upturned feathery eyebrows and often grow feathers in their hair and claws on their fingers as well. (The claws are decorative in nature and cannot be used as weapons.)

Biata tend to be very orderly in their philosophy of life—they always act with a purpose. They will not do things “on a whim” and are always working towards some goal. To other races, this tends to make them seem like extremists—either very good or very evil—but even the most evil biata will have his or her own code of ethics and will never act erratically or randomly. This also makes the biata seem very stubborn.

They are also very secretive about the origins of their race and will treat all other races as “outsiders” rarely worthy of complete trust.

It is said that biata were formed through magical mating of a gryphon and a human (or perhaps a barbarian). The Gryphon barbarian tribe was made up entirely of biata and until the last Great Celestial Change in 590, all biata looked like humans.

Having celestial protective spells cast upon biata causes great discomfort. Most will refuse to sleep behind Wards and will not use celestial magic items. All players are encouraged to role-play their characters in any way that they consider fun.

Mentalist: Biata, like stone elves, have spent years honing mental skills and as such can perform certain mental abilities. These abilities are all completely role-playing in nature. Generally speaking, a biata can remove role-playing insanity based on memories or otherwise “cure” mental damage on any willing subject. You cannot use this ability to tell if another player is telling the truth or to have that player remember events forgotten due to a *FORGET ELIXIR* or otherwise get around any NERO rule. A player always has the right to refuse to role-play any of these skills and can at any time decide to “break off” contact or be cured. In order to use this role-playing skill, you must touch the other person and concentrate completely by either staring into each other’s eyes or by both of you having your eyes closed. You cannot perform any other in game skill while role-playing this. Any biata who simply touches someone and says “There, you no longer have a fear of heights (or whatever)” is not playing the race properly. For more information about these skills, see “Mind Abilities” in the chapter on Special Abilities.

Biata can buy the skills *BREAK CHARM*, *RESIST CHARM*, and *RESIST SLEEP*. Biata cannot learn *READ MAGIC*.



Drae

Drae are dark elves, a mysterious race that mostly lives underground, shunning sunlight. They have jet black skin, white or silver hair, and pointed ears. They rarely socialize with other races. They keep to themselves and generally feel themselves to be superior to all other races.

When playing a drae, the most important thing to remember is honor. The Drae culture emphasizes honor to such a degree that a Drae who has lost honor should commit suicide as punishment before honor can be regained. This does not mean that you cannot be an evil Drae; it merely means that you will keep your word once it is given. If you are disgraced in any way, you will publicly do what needs to be done for your honor to be restored.

Drae can have a sense of humor but must take their own actions very seriously. There are drae entertainers (though rare) but even these regard honor as the highest attribute.

Drae have -2 Body Points in the daytime (defined as 6 a.m. to 6 p.m.). At 6 a.m., the drae loses 2 points from their maximum Body Points (never below one Body Point), adjusting their current Body Points to match if necessary. This means that a drae will never fall unconscious due to this penalty. At 6 p.m., the drae's maximum Body Points go up by exactly the same number of points that they went down the night before. This rule cannot be used to circumvent other effects where Body Points are lost.

Drae can buy *RESIST SLEEP* and *RESIST CHARM*. They can also buy the *ARCHERY* skill at half cost (round up), but they cannot use *TWO HANDED BLUNT* weapons or *TWO HANDED SWORDS*.



Dwarf

Dwarves are sturdy individuals who live in mountainous regions. Dwarves in NERO are not necessarily short (remember that all players and monsters are the same size as the person playing them), but taller players should think twice about playing a dwarf. In-game, the rumor is that dwarves are the small cousins of hill giants, and so to the giants, they were seen as short.

Dwarves tend to be friendly but secretive. They all have beards, although many females prefer a long goatee. Their race enjoys and appreciates good craftsmanship, especially in weapons, armor, and jewelry. Because they live so much longer than humans, they tend to dislike the humans' faster paced lifestyles (but they generally like the food).

Dwarves have an extreme hatred of trolls who often attack and take the dwarven caves for themselves. Their history is very lengthy but is mostly comprised of stories and legends of great dwarven heroes. Some of these stories can take many hours or even days to tell completely, and no self-respecting dwarf would consider telling an abridged version.

Dwarves are generally peaceful and have no problem with other races—although they think elves are pompous, humans are impatient, hobblings are troublemakers, and half-orcs and half ogres are incapable of understanding the finer things in life (like a well made weapon and a fine wine).

They start with one extra body point, can buy *RESIST POISON*, and can buy the *SMITHING* skill for one point less. Dwarves cannot use *POLEARMS*, *STAVES*, *TWO HANDED BLUNT WEAPONS* or *TWO HANDED SWORDS*. They must pay double for *READ MAGIC*.





Elf

Elves are long-lived people with pointed ears. That may be the only thing all the elven races have in common!

All elves can buy the skills *RESIST SLEEP* and *RESIST CHARM*. They have one less Body Point than a human character of the same class and level. They can buy the *ARCHERY* skill at half cost (round up), but they cannot use *TWO HANDED BLUNT* weapons or *TWO HANDED SWORDS*.

There are many varieties of elves. The most common are:

Amani elf

Amani elves are descendants of Quentari elves. Many years ago, a political rift developed in Quentari and many of the elves moved to the Ash Forest (or the “Amani” forest in their language) in the Duchy of Ashbury in Evendarr to start anew. Since then, they have spread all over the continent.

Amani elves are friendlier and more down-to-earth than their Quentari cousins. They get along much better with other races but still do not socialize a great deal with them. Even though they socialize with other races, they rarely marry any other than their fellow Amani elves. An Amani who falls in love with another race is not shunned from the society, but is obviously not treated with the same degree of respect by his or her fellow Amani elves.

Quentari elf

Quentari elves come from the elven kingdom of Quentari. They consider themselves to be the most civilized race; all others are barbaric in comparison. To some degree this is true—they have the oldest culture, the greatest cities, and the most learned scholars. It is this attitude however that makes their living with other races a problem, as no one likes being seen as inferior. Quentari elves tend to be scholars, and it is rare to encounter a Quentari elf who does not know how to read and write. When fighting, they tend to prefer bows and short swords, but fighting is seen as a last resort when peaceful negotiations are unsuccessful.

Stone elf:

Stone elves have whitish skin, upturned eyebrows, and pointed ears. Stone elves do not show emotions and as such are viewed by other races as humorless and intense. This is part of their culture as well as being part of their race. This restriction makes the stone elves very hard to role-play—if you cannot keep a straight face when told a funny joke, you should not be playing a stone elf.

They have a natural affinity for celestial magic and make excellent celestial casters. Although there are of course healers in their society, most stone elf casters are celestial.

Mentalist: Stone elves, like biata, have spent years honing mental skills and as such can perform certain mental abilities. These abilities are all completely role-playing in nature. Generally speaking, a stone elf can remove role-playing insanity based on emotions or otherwise “cure” mental damage on any willing subject. You cannot use this ability to tell if another player is telling the truth or to have that player remember memories lost to *FORGET ELIXIRS* or otherwise get around any *NERO* rule. A player always has the right to refuse to role-play any of these skills and can at any time decide to “break off” contact or be cured.

In order to use this role-playing skill, you must touch the other person and concentrate completely. Any Stone elf that simply touches someone and says “*There, you no longer have a fear of heights (or whatever)*” is not playing the race properly. For more information about these skills, see “*Mind Abilities*” on page 93.

Wild Elf

Wild elves live in nomadic tribes like barbarians and share many barbarian traits. Wild elves are distinguished in-game by their furs and other barbarian clothing, even though they have pointed ears like all other elves.

Wild elves are not treated as “*real elves*” by most of the rest of the elven race. There is no outright warring going on, but the wild elves often feel as if they are second-class citizens even though they generally have all the rights as any other citizen.

The wild elf society places an emphasis on hunting and tracking skills.



Gypsy

Unlike other races that are distinguished by physical features, gypsies are defined by costume, behavior, and culture. To be a gypsy means to be boisterous, extroverted, and larger than life. Gypsies, a fiery and passionate race, love to dance and sing. The most important aspect of gypsy life is family. The gypsies have enormous loyalty to their people, treating each as a family member and referring to them as “brother” or “sister.”

Many gypsy tribes may coexist in the same area, each being ruled by its own Bandoleer or “Prinzel/Princess.” There is a Gypsy King but quite often this figure is far removed from normal gypsy life and has no great influence over the local tribes. Usually a gypsy tribe will have its own distinctive predominate color or marking, used to differentiate itself from other tribes in the area.

Gypsies can bestow or remove Gypsy Curse, the use of which is limited by the Gypsy Code of Honor. The Gypsy Code of Honor requires that a gypsy be always honest and trustworthy among members of his or her own tribe. The gypsy will support the other tribe members and will do whatever it takes to help (including lying to, stealing from, and cursing or killing non-tribe members).

The Gypsy Code of Honor means respecting the actions of fellow gypsies as well. If a gypsy places a *GYPSEY CURSE* on someone, it had better be for a good reason (sometimes, the recipient might take action against the entire tribe). If there was a good reason, then the entire tribe will support that gypsy.



Half Ogre

Half ogres are not human/ogre hybrids, but rather are a race that closely resembles ogres in coloration and behavior and were dubbed half ogres by those that first encountered them. They have yellow skin and protruding lower fangs. Half ogres are tougher than average and are almost always fighters. They tend to be less intelligent and should role-play difficulty in understanding complicated subjects. Note also that half ogres have a very short life expectancy compared to other races, and they mature faster, so that your starting character may only be four years old!

Half ogres are very tough fighters and they know it. It is very rare for a half ogre to show any fear. They are usually first to run into battle and will almost never run away. However, they have an innate fear of undead and will have to summon up a ton of courage to fight any zombie, skeleton or vampire that comes their way.

Half ogres tend to see the world in simple ways. What good is writing if you can't fight with it? They think most of the other races are spoiled and live too fancily. Half ogres would rather spend their money on new weapons and armor than on fancy homes, fancy food, or fancy clothes. Half ogres think that the concept of nobility is the most ridiculous idea “civilized” society has to offer. In the half ogre tribes, the tribal leaders are the best fighters. In fact, half ogres are constantly fighting among themselves for dominance.

If a half ogre sees another, it is likely that they will fight to establish who is dominant. The fight is never to the death but only until one of the half ogres acknowledges the other's superiority. There is never any cheating nor are there sneak attacks in this sort of battle; there is great honor at stake in the half ogre community.

They start with two extra Body Points and must pay double for all Scholarly skills *see Table 3-2 on page 30*. Half Ogres may purchase the skill *STRONG-ARM* once.



Half Orc

Half orcs may have at one time been human/orc hybrids but have now evolved into a race of their own. They have green skin and protruding lower fangs or teeth. They are a strong people, but tend to be less intelligent and should role-play difficulty in understanding complicated subjects. Because of this Orcish Society is primitive and brutal. Orcish culture is based on the concepts of might makes right. They would rather die in combat than of old age, and would never be seen running from a battle unless the situation was completely overwhelming. Scholars are very respected among the Half Orcs as wise-ones and healers, and the harming of one can carry dire consequences.

The half orc society is clan-based, where families and blood relations are regarded as most important. Individual half orcs may leave the family to adventure with other races in order to gain in strength and earn a name for themselves. Half Orcs reach maturity quickly, and most are capable of using a weapon at age 4.

Half orcs start with two extra Body Points. They must pay double for all Scholarly skills *see Table 3-2 on page 30*. Half Orcs may purchase the skill *STRONG-ARM* once.



Hobbling

Hobblings are peaceful people and generally are smaller than average. They have furry feet and hands, as well as bushy sideburns and eyebrows.

Hobblings love working with their hands and as such are often craftsmen. They are friendly and cheerful and have a great sense of humor, and quite often use their charisma to their advantage. Hobblings do not generally like adventure even though they love the treasure that can come from adventuring. Their treasure will be spent on fine food, good clothes, and a high standard of living. Their love of living well means that most Hobblings are business people first. The thought of doing something for free is appalling to them, and although to some this appears to be mere laziness, Hobblings consider this common sense. They are completely honest in their business deals however and always keep to their promises once made—however, you'd better read any contract with a hobbling very carefully, as they know all the loopholes. They make excellent spies as long as the money keeps coming in.

Hobblings begin with one less Body Point. Hobblings cannot be fighters and cannot use *BOWS, CROSSBOWS, POLEARMS, STAVES, TWO HANDED BLUNT WEAPONS* or *TWO HANDED SWORDS*. They can buy *PICK LOCKS* and *DISARM/ARM TRAP* at half price (round up) and can buy the racial ability *RESIST POISON*. Hobblings may purchase the skill *HOBLING DODGE* once.





Mystic Wood Elf

Mystic Wood elves are an eccentric race originally from the Mystic Woods in Northern Evendarr. They are not really elves but were called that by the people who first encountered them. Mystic Wood elves have elven ears but also small horns on their foreheads. Popular theory holds that they are descended from elven-satyr/nymph hybrids, but this has never been proven. Mystic Wood elves hate (or at the very least find distasteful) all forms of enslavement, from slavery and kidnapping to magical charms and alchemical controls. For example, a Mystic Wood elf that finds a *CHARM* elixir will probably destroy it. They may also attempt to break charms they find on others.

Mystic Wood elf society is organized into 3 major clans, and these clans are viewed as family by the Mystic Wood elf. Mystic Wood elves hold oaths to be extremely important. Mystic Wood elves have two names, their "road" name which they commonly use, and their "real" name which they usually only share with their most trusted friends outside the Mystic Wood elven community. Mystic Wood elves have a remarkably high tolerance for alcohol and love travel and adventure. For them, getting there is not half the fun, it's all the fun.

Mystic Wood elves are natural born artisans and can buy the *CRAFTSMAN (OTHER)* skill for 2 build points instead of the 3 build that it costs other races. For each level attained, a Mystic Wood elf must buy at least one skill from "Magic Skills," Table 3-2 or "Trades and Crafts," Table 3-3 on page 30. Mystic Wood elves can also buy *RESIST CHARM* for 3 build and Break Charm for 2 build. As they are not elves, Mystic Wood elves do not lose 1 body and can use *TWO HANDED WEAPONS*.



Sarr

Sarr are a race of felinoids and many, but not all, come from a land known as Myrr. They live in a matriarchal society, with women outnumbering men several times over. There are multiple clans among the Sarr, each one representing a different type of large hunting cat. Each clan has different beliefs, leaders, history, and behaviors.

Sarr are curious, loyal, independent, and extremely proud. Tradition is highly valued among the Sarr. The Sarr race has an affinity for Earth Magic, but members of the Lion clan are known to be very proficient with Celestial Magic. This does not mean that you must play a Lion if you wish to use Celestial Magic, just that you may be looked down upon by the other clans if you break from tradition.

Sarr will form attachments with adventuring groups, but they will also strike out on their own in search of adventure when the urge hits them. Do not think that Sarr are cute little fluffy house cats; they are some of the fiercest warriors of all the races. They never forget an enemy and always seek revenge no matter how long it takes.

Sarr must wear makeup to appear as one of the large hunting cats. The bottom of the nose should be dark. Whiskers, stripes or spots may be added if appropriate. If you play a black panther Sarr, you must wear a prosthetic cat nose, cat ears, or other additions to make it clear to all that you are not a drae.

Scenting: Sarr have superior scenting abilities, and as such may detect an alchemical substance or disease on an item if they spend three seconds inspecting it. This racial skill does not allow them to tell what kind of alchemical substance or disease is present.

Sarr may buy the skill *RESIST POISON*. Sarr cannot use *BOWS*, *CROSSBOWS*, *ONE HANDED BLUNT* weapons, *STAVES*, *THROWN WEAPONS*, or *TWO HANDED BLUNT* weapons. The only *SMALL WEAPON* allowable is a dagger or hatchet. All weapons must be edged.



Scavenger

“Scavenger” is a generic term used for any type not covered by the other races. They are humanoids with the characteristics of a mundane animal (rat, badger, skunk, dog, etc.), but not magical animals such as Drakes, Gryphons, Unicorns or the like. Players are free to use their imagination in creating a scavenger as long as makeup is worn and it is obvious that the player is not playing a monster or another player race. (For example, you cannot be a “cat” scavenger because there would be no way out-of-game to differentiate you from a Sarr.)

Scavengers should role-play their particular animal’s characteristics to whatever extent they see fit, but animalistic traits must be evident in some way.

While some scavengers are closer to their animal half and do not understand the concept of possessions or the niceties of civilization as do the other races, others are truly civilized cultures with long histories. There is no commonality between different types of scavengers other than the fact that they appear to be humanoid animals. Some scavengers are very hardy survivors on the fringe of civilization and others are noble beings descended from generations of city dwellers.

There are a few traits that these animalistic humanoids share just from being animal-like.

Scenting: All scavengers have superior senses of smell, and can use Scenting Abilities that allow them to detect an alchemical substance or disease on an item if they spend three seconds inspecting the item. (This racial skill does not allow them to tell what kind of alchemical substance or disease is present.)

Scavengers can buy the skill *RESIST POISON*.

In addition the animal part of them makes it harder for them to learn to read than it is for other humanoids and thus they must pay double cost for all Scholarly Skills *see Table 3-2 on page 30*. Note that this does not necessarily make them less intelligent than any other race, just less able to read.

Cultures

In addition to playing various races, it is fun to play a character from an unusual culture as well. The in-game guides to the various countries and duchies of the NERO world can give you some ideas. The more cultures we have in the game, the richer the role-playing experience.

You might also wish to create your own culture. However, understand that you should be very careful about what you say in-game about your culture; because you may end up having to take it all back if the Plot Committee says no. You must make sure that nothing in your concept of this culture violates NERO policies, rules, or the in-game history!

You cannot be a traveler from another planet or from the future or from a modern democratic society; the basic concepts of medieval society should still exist. Use the current countries as described in your chapter’s *players guide* as a guideline.

You should write up your concept of your culture and submit it to your local Plot Committee for approval along with your character history. If you want to show up to an event playing that character before the history is approved, you should refuse to speak about your culture too much in game. Also note that any culture suggestions, once accepted, become the property of NERO.

This is a delicate balance we are creating; we want to encourage players to create more than a strictly European medieval feel to the game while at the same time we want to prevent the game from becoming impossible to manage. We can’t have six separate island nations at exactly the same spot on the globe. That is why it is imperative that if you want to talk about your culture in-game, you must get it approved by the Plot Committee. In addition, you should be careful if you wish to play a culture that is based on a real Earth culture. For example, if you wish to play a barbarian based on an American Indian culture, please make sure that you know something about that culture. If you walk around saying “ugh” and “how” and calling people “Kemosabe” you may be asked to stop. The best bet is to not play a character from a real culture with which you are not very familiar. We love having characters from societies based on medieval Japan or ancient Egypt or the Hawaiian Islands or Africa, but we definitely do not want players with no knowledge of those cultures to play insulting stereotypes from those cultures—even if no insult was intended.

The most important thing is to prevent your character from being insulting to people whose heritage really is of that culture. At the risk of saying we want PCPCs (Politically Correct Player Characters), please be careful. Just think first.

Monsters & NPCs

NPCs (Non-Playing Characters) and Monsters are guided by a Monster Master who assigns them duties. The Monster Master, in turn, answers to the Plot Committee and their weekend director. If an NPC character dies or completes his or her assignment, the NPC player must return to the monster cabin (which is off-limits to everyone except NPCs and marshals). They can then be sent out again as another NPC.

Many NPCs are used in set encounters like guarding a tomb or

capturing a character. Others simply wander around the woods looking for unsuspecting adventurers to fight. There may be specific monster areas in the woods where certain types of monsters appear from time to time and wait for the adventurers to find them.

All NPCs aren't necessarily monsters nor are they placed out there just for PCs to fight. NPCs may be bards and entertainers, beggars, merchants, hired thugs, or anything else needed to advance the proper town atmosphere. NPCs that are not monsters should be indistinguishable from any player.

There may also be some full-time town NPCs such as the major Guild leaders and some of the highest nobility. They are NPCs because they also serve a logistics function or because they are controlled by the Plot Committee. These NPCs, like all NPCs, have a limited number of lives and in all aspects must follow all game rules.

Players who wish to be NPCs get compensation for the work they do. In exchange, we expect our NPCs to do what they are told and follow the rules.

Monster Size

All monsters are the size of the NPC or physical representation playing the part. There are not any 9 foot tall trolls unless there is a 9 foot tall NPC playing the part or a 9 foot tall apparatus built for that purpose.

Matters of Life and Death

States of Existence

There are three Standard States that someone at a NERO event can be in. These are:

- 1) *OOG: Out Of Game*
- 2) *IG: In game and completely visible to those around you (Yes, you can try to hide in bushes, etc... but you actually have to hide.)*
- 3) *Spirit: In game and a spirit*

Alternate States (such as flying, burrowing, invisible, etc.) are not possible.

Out-of-Game

When someone takes themselves out of the action for their own convenience, they are out-of-game. In order to go out-of-game, you must wear a white headband. This signifies to others that your character is not there. Please do not abuse this, and note that your game items must stay in-game.

Bathhouses or similar facilities are out-of-game. You may not however run into one if monsters are chasing you. Anyone traveling to and from the showers may be out-of-game if they so choose. If they are out-of-game, though, they should have no game items on them.

As a courtesy you can sleep in a cabin out-of-game. However if someone has a real reason to pull you back into game, you may be disturbed. For Example, if you have an important game item that half the players are looking for, then a marshal may come by looking for it. If you have done something to anger another group, or even a bunch of monsters, then you may not run off and put your cabin out-of-game to avoid the consequences. A marshal will likely be involved and you will be presented with several options, such as; you are at the mercy of the injured parties or you may opt to fight, at which point combat could commence. In such cases, you will be given only as much preparatory time as you would have actual warning, again decided by the marshal.

You cannot go out-of-game in the middle of a combat unless you have a medical reason.

Hit Points

Your character's health and the quality of his or her armor are represented by the use of Hit Points.

There are two types of Hit Points: Armor Points and Body Points. **Armor Points** represent the additional protection that is gained from armor. These points are usually lost first.

Body Points represent how strong and healthy your body is at that moment. When in a battle, armor usually takes damage first and then Body Points. There are exceptions. Some spells and skills state that only body or armor is affected.

Body Points do not regenerate from day to day but you will receive your full amount of Body Points at the start of each new NERO event.

Please note that there is no mechanism to dismember bodies in NERO.

You must update your Armor Points and Body Points at the end of a battle to reflect those lost during combat. This is done by adjusting your tags or updating your character skill sheet. Armor tags do not need to match the physical representation worn. If you are wearing a phys-rep for 6 points of armor you can use a 15 point tag, but you can only gain the benefit of 6 points of armor from that tag. In order to get full benefit from the 15 point armor tag, you must be wearing a phys-rep for armor that gives at least 15 points.



Life and Death

Knowing the rules in this section can literally make the difference between life and death. Some of this will be confusing upon a first reading, as this section makes references to rules that have not yet been covered. If this is your first reading of the NERO© Rule Book©, get the general idea of this section and then come back after you've read more.

Unconscious:

If you are reduced to exactly zero Body

Points, then you are unconscious. You will regain consciousness at one Body Point only after one minute.

You can make no sounds at all while unconscious or dying. If your party doesn't notice you lying there, you can't moan or say "Well, it looks like I'm unconscious."

Carrying the Incapacitated:

To carry another character or creature that is incapacitated, you must place a hand near the torso and tell the other player "I am carrying you". The recipient must get up and stand in front of you. Then you hold both hands over their shoulders to indicate you are carrying them. Both hands must be free. You must walk at a normal pace. You may walk forward or drag them by walking with them backwards. Whether walking or running you must wait for the person playing the body to get up and follow you. You cannot "tag" them and sprint, claiming that you have the body. The person must move with you. If a packet, weapon, or other game effect strikes you or the body being carried, you must drop the body. You may pick it up again once it stops moving. The effect is applied to whomever it hit, following all normal NERO rules. All of the same rules apply if you use a game effect upon yourself, including *IMPRISON*, healing spells, or gaseous form. If you cast Imprison upon yourself or go gaseous, the carried body must be dropped and hence cannot be included in the effect.



continue the death countdown from where it was frozen by the *FIRST AID*.

If the *FIRST AID* is completed, then you will be at zero Body Points (unconscious) and will wake in 1 minute with 1 Body Point. *FIRST AID* is not required if you are at 0. Curing that brings you to at least 1 Body Point will immediately bring you to consciousness without the minute needed for *FIRST AID*.

If you are at -1, then for all healing it only takes 1 point to reach zero. So, for example, if you received 5 points of healing you would have 4 Body Points.

Dead:

If you are still at -1 Body Points after completing your Death Countdown, then you are dead. Death may also come from Killing Blows (see below) and certain effects. All of your active spells, alchemical substances, and other effects will immediately disappear. The only things that will remain are *GYPSY CURSE*, *FORGET-IT-WELL*, *FORGET-ME-NOT*, and *ENSLAVEMENT*. Sometimes, a *CURSE OF*

TRANSFORMATION or an *INFECTION* might disappear when a character dies. No other game effect is active after death, except for certain Formal Magic Spells (this will be stated on the tag).

The only thing that can save you now is a *LIFE* spell delivered within five minutes.

Even if a *LIFE* spell is given to you, all your active spells, alchemical substances and other effects (except those listed above) are lost. If the five minutes pass without a *LIFE* spell then your body dissipates, all of your in game items drop to the ground, and you must immediately become a spirit and can only be brought back by a resurrection.

Dying:

Any time you are reduced below zero Body Points, you drop to -1 and no further, even if the last blow to you did 48 points of damage. Once you are reduced to -1, then your character is dying.

Killing Blows

There are many ways in our game to render an opponent completely helpless. These include Web spells, Paralyze spells, tying them up physically (thus making them immobile from the neck down), or

Table 2-2.

HEALTH		LIFE AND DEATH						
		TIME (MINUTES) →						
		0	1	2	3	4	5	6
Unconscious (0 body)		■	■					
Dying (-1 body)		■	■	■	■	■	■	■
Dead		■	■	■	■	■	■	■

- Conscious with 1 body
- Any Healing
- First Aid brings to 0 body
Any Healing Works
- Life Spell Needed
- Resurrection Needed

You will die unless given *FIRST AID* or curing within one minute. This one minute is referred to as your "death countdown."
FIRST AID takes a complete uninterrupted minute to be successful. Once *FIRST AID* has begun; with the call "First Aid", the one minute death countdown freezes. If you receive another hit while in this condition, then the aid is considered to be interrupted and you will

just hitting them until they drop unconscious.
Once a person has been incapacitated, it is not too difficult to kill them. This is represented by a Killing Blow.
If the character is being actively guarded by companions, however, it is another matter entirely! When you have leisure to do so, it is easy to find a chink in the armor or slip a dagger under the

helmet and deliver a Killing Blow. It is considerably more difficult to do so if someone is trying to prevent you from accomplishing that very feat. Therefore, there are a few restrictions as to its use. To administer a killing blow, you must place your weapon or touch a packet in your hand somewhere on the victim's torso and remain in that position while you recite "Killing Blow One; Killing Blow Two; Killing Blow Three <damage type>."

If anyone strikes you during the count or knocks your weapon away, then Killing Blow is interrupted and fails to kill the person. Please note that even though there is a three-count for Killing Blows, the Killing Blow only counts as one strike.

A Killing Blow must be administered to the torso of the victim; an arm, leg, or shoulder is not sufficient. Likewise, the blow cannot be struck on a moving target. If you have Waylaid someone, you must wait for the body to come to rest before you can deliver the Killing Blow.

A Killing Blow can be delivered by anyone, whether they have a weapon or not. Some creatures are immune to normal weapons. To be effective, the Killing Blow must be applied with a weapon that can damage the creature. No skill in the weapon is necessary. For example, if a creature is affected by silvered or magical weapons but not normal weapons, the Killing Blow must be applied with a silvered or magical weapon. In such a case, using a hand to perform the Killing Blow would not work.

Once a Killing blow has been given to you, you are dead and should begin your death count.

Spirits

When your character dies and their body dissipates (after the point at which a *LIFE* spell will no longer work) you must become a spirit. You must drop all in game items, put on a white headband and head immediately and directly to your chapter's resurrection point (usually the Healers' Guild) to register your death. The spirit is completely invisible to the world around it and may not interact in any manner with other characters (no noises, no charades . . . nothing!). Spirits travel only as fast as the player walks—no running to the Healers' Guild.

It is impossible to burn or otherwise completely destroy the body before the five minute *LIFE* spell requirement is used up. There can be no effects that can accelerate the destruction of the body of a PC except for the specific exceptions outlined in the Formal Magic System. We know this doesn't make complete in-game sense but this

rule is to prevent every single kill from turning into a "Let's burn the body!" situation.

Resurrections

Spirits are resurrected in Extended Earth Circles created through Formal Magic. Very often a local Healers Guild safeguards such a Circle in order to perform resurrections. Upon entering the

EXTENDED EARTH CIRCLE, the spirit remains unable to interact with characters, but anyone inside the Circle and Invested in the Circle will "sense" a presence and will know the identity of that presence if it is someone they know. They

may then resurrect that spirit, and after five minutes the body will be restored to the spirit. The identity of the spirit does not have to be known in order to be resurrected. You must be invested in the Circle to be able to start the resurrection, but once it is begun anyone with the skill of *HEALING ARTS* can complete it. If no one is available with *HEALING ARTS*, then the spirit can resurrect on its own once the Invested

member has begun the resurrection. However, in-game this is very painful emotionally to the resurrecting character.

A spirit can reject a specific healer but stay in the Circle waiting for another person to perform the resurrection. The rejected healer will be aware that the spirit is refusing to resurrect under his or her guidance but will not be able to tell which healer the spirit is "requesting" or waiting for.

The spirit is not aware of any character plans to resurrect in specific circles based on the means of death. Thus you cannot say to your friends "If I resurrect in Bristol, that means that Enemy X killed me; and if I resurrect in Wildwood, that means Enemy Y."

The spirit will normally go to the closest Extended Earth Circle of Power to resurrect. No in-game knowledge is necessary for your spirit to find the "closest" Earth Circle. This includes Circles that your character has never seen in game. A spirit can choose to go to a different Circle than the closest one if the closest Circle is hostile, but the character, once resurrected, will not be aware of this decision. The Player, not the character, determines "hostility". This is a fine point at best, but it means that out-of-game knowledge is used when deciding whether to resurrect at a given circle. For example, let's suppose your character dies and a *FORGET POISON* is used. When your body dissipates, you go to the Earth Circle. When you get there, you see your character's killer hiding behind the cabin where the Earth Circle is located. You decide to resurrect elsewhere because the circle is "hostile" to you. This is allowed and is well within the rules. As a matter of fact, no one in the game, not even a



marshal, can require another player to justify why they decided that a particular circle is "hostile". It's an out-of-game decision made by the player, and can be made for no reason at all. The decision to resurrect elsewhere can even be made after the resurrection has started. Of course, once the resurrection is finished it's too late.

If your character decides to go to another Circle other than the designated in-game Circle during a weekend event, you must go to the resurrection point out-of-game to record the death and let them know what you are planning. You may be required to stay out-of-game for a period of time to represent the amount of time it would take for your spirit to travel to the next closest *EXTENDED EARTH CIRCLE* and for your body to then travel back.

It is impossible to tell how someone died from looking at their spirit so at this point determining the method of death is not possible.

Many resurrections are performed by a character who tells a story about the events of what occurs during the five minutes and the person receiving the resurrection may choose to have their character believe that story, or any other as they prefer. Each and every story should abide by NERO rules and any problems should be reported to a Marshal.

At the end of the resurrection, the player must say "I reform one, I reform two, I reform three". There is nothing that will successfully affect a resurrecting body during this three count. The last three seconds are considered part of the time in which the spirit "cannot interact with the world around it" and hence nothing will affect the character. You cannot begin any three count, including a killing blow, upon a resurrecting body until after the resurrection count is over.

A newly resurrected character has his or her maximum Body Points and will awake from resurrection without any game possessions at all but clothed. All remaining spells and elixirs that were present on the character will be gone, including *GYPSY CURSE*

and *ENSLAVEMENT*.

Anyone who resurrects at a full earth circle will have their skills renewed. This does not include craftsman skills or production skills, but does reset Formal Magic casting ability and Formal Cantrips.

Most of the time, a *CURSE OF TRANSFORMATION* or an *INFECTIO* will disappear when a character is resurrected. Note that the lost memories from *FORGET POISONS* are not restored by resurrection. No other game effect is active after death, except for certain Formal Magic which will be stated on the magic item tag.

Each time your character dies, he or she adds another Death to their Death Total. Every character gets two guaranteed resurrections. After that, there is a chance of dying permanently and not coming back.

When you show up at the earth Circle to resurrect, a Marshal will update your Death Total and then will ask you to choose from the Bag of Chance.

In the bag will be ten stones. There will be one Death Stone for each time you have died beyond the two free resurrections. In addition, there will be a number of Life Stones put into the bag so that the total number of stones is always ten. If you choose a Life Stone, then you can successfully be resurrected.

If you pick a Death Stone, then your character has permanently died. At this point, your character's body reforms exactly where it dissipated. The body will remain there until someone finds it and takes it.

However, lying out in the middle of the woods all night hoping someone finds your body is not fun for most players. Therefore it is completely acceptable to leave a note saying "You see Raymond's body here." Any spirit-linked items will remain there and will be spirit-linked to the next appropriate person who touches them.

First Event Deaths:

Any first-time NERO player will not have any of the deaths taken



during his first event count toward his character. This policy is done as a service to new players so that they can get used to the game before being penalized for their deaths, not as a way to abuse the system and be immortal. This is out-of-game knowledge, so deaths taken by a new player should still be role-played appropriately. Any player that is deemed to be abusing this policy for intentional gain or detriment to the game or other players will be dealt with accordingly, at the discretion of the local chapter affected. This benefit is only given during a player's first game, and experienced players that start a new character will not be allowed these unlimited deaths.

Build Points therefore all characters start at second level. These 30 Build Points are used to buy the character's initial skills.

Levels

Your level determines how many Body Points you get and how many Experience Points you need to get a Build Point. Table 2-4 shows the character's level based on the total Build Points. It also shows the number of XP needed for the next BP, and the Body Point value per class (fighter, rogue, scholar, and templar) for the level attained.

Character Advancement

Experience Points

Experience Points (XP) are used in NERO for the advancement of a player's character. Whenever you attend a regular 2 day weekend event in NERO you receive a

Event Rewards Table 2-3.

EVENT DAYS	BLANKETS
1	0.5
2	1
3	1.5
Adventure day	0.25

"blanket" of Experience Points equal to your current total Build Points.

Some events are shorter or longer and therefore worth different amounts of XP.

It is possible to, at maximum, double this experience through several means.

At the end of the event, you may pay to the game staff one silver per additional experience point you wish to gain. This is known as "Maxing Out." You may also pay less than the maximum amount for correspondingly less gain.

Ex. Dave has 40 build points, he receives a Blanket of 40xp for attending a two day event and can pay 1-40 silver for an extra 1-40xp.

Some chapters will let you max out through helping NPC, or clean-up/setup duties and some will let you max out automatically. See your local chapter for their policies on max out.

Build Points

Experience Points are automatically converted to Build Points (BP), which you then use to buy skills for your character. The amount of Experience Points needed to buy a Build Point is based on your level. Your level is determined by how many Build Points your character has. It takes 10 Build Points to gain a level. All characters start with 65 XP which equals 30

Advancement Chart Table 2-4.

LEVEL	TOTAL BP	XP/BP	BODY POINTS			
			F	R	S	T
1	15 - 24	3	6	4	3	4
2	25 - 34	7	8	5	4	5
3	35 - 44	12	10	6	4	6
4	45 - 54	18	12	7	5	7
5	55 - 64	25	14	8	6	8
6	65 - 74	33	16	9	6	9
7	75 - 84	42	18	10	7	10
8	85 - 94	52	20	11	8	11
9	95 - 104	63	22	12	8	12
10	105 - 114	75	24	13	9	13
11	115 - 124	88	26	14	10	14
12	125 - 134	102	28	15	10	15
13	135 - 144	117	30	16	11	16
14	145 - 154	133	32	17	12	17
15	155 - 164	150	34	18	12	18
16	165 - 174	168	36	19	13	19
17	175 - 184	187	38	20	14	20
18	185 - 194	207	40	21	14	21
19	195 - 204	228	42	22	15	22
20	205 - 214	250	44	23	16	23
21	215 - 224	273	46	24	16	24
22	225 - 234	297	48	25	17	25
23	235 - 244	322	50	26	18	26
24	245 - 254	348	52	27	18	27
25	255 - 264	375	54	28	19	28
26	265 - 274	403	56	29	20	29
27	275 - 284	432	58	30	20	30
28	285 - 294	462	60	31	21	31
29	295 - 304	493	62	32	22	32
30	305 - 314	525	64	33	22	33

the skill system





ERO characters advance by purchasing skills. Each skill you learn allows you to perform a particular task or group of tasks. Many can only be used a limited number of times per day. Some skills allow you to improve your abilities when

the skill is bought multiple times. Be sure to carefully read the skill descriptions.

Standard Reset

In any case where a skill can be used only a certain number of times per day (such as Critical Slays or spells), the used skills will not return to you until the next day at 6 PM. This is known as a reset. On adventure days the reset happens before each module or adventure.

Limited Reset

Some chapters offer an additional reset of times-per-day skills at 6 AM. These are called "limited resets" and do not refresh craft/production skills, formal magic skills, Cantrips, or magic items. Information on whether or not your local NERO Chapter is using the Limited Reset rule will be available on their web site, at the event, and often announced at the Opening Ceremonies of the event.

The Skill System

NERO is a fantasy game. By that, we mean that it is a compilation of rules and customs by which we allow people to simulate doing things that they cannot really do. The most obvious of these things is magic.

You should not be fooled into thinking that your personal skill equates to the character skill it represents. For instance, we have

weapon skills. You must have the *ONE HANDED EDGED* weapon skill before you are allowed to use a long sword. Many people have asked if they can at least pick up a sword and block blows with it—after all, anyone could make the attempt, could they not? The answer is no, in our game they cannot.

The level of ability represented by the skill bought can be considerably different from that of your average player. It represents a skill that has required hours of practice a day for months to gain. When such an individual is faced with a person totally unskilled in weapon use, they would strike the person down with ease. The player's skill may be somewhat less than that of the character, however, so the restrictions are used to simulate the skills.

Similarly, the proficiency system represents a level of skill that the player might never obtain. We use it

as a way to artificially give a player's character, no matter what his or her real world skill, an advantage over another whose character is not as skilled. It allows a player of indifferent skill to defeat or hold their own against a player of much greater skill.

This is, after all, a fantasy. A person should be able to acquire skills that allow their character to do things that they themselves could not do in real life.

Spell Slots

There are special rules for spell acquisition that are unlike most other skills in the game. When you purchase a 1st level spell from the skill list, what you are actually buying is the ability to memorize and cast one 1st level spell. This is known as a *Spell Slot*.

You may memorize any 1st level spell and store it in this slot. Only one 1st level spell may be stored there at any time. Once that spell has been cast, the slot will become empty and will remain that way until the next limited, or standard reset, or until it is refilled by other means.

If you have several spell slots of a given level, you can fill them with any combination of spells (of the appropriate level) that you know.

You must buy spell slots in a proportional pyramid fashion. If you wish to buy a spell slot of a particular level, then you must have two spell slots of the level below.

In other words, you must have a minimum of one spell slot difference between any adjoining levels and a maximum of two spell slots difference. If you wish to buy your first 2nd level spell slot, you must have at least two 1st level spell slots already, but you may not have three.

Once you have purchased four spell slots of any particular level,

then you need not buy any additional spell slots of that level to complete the pyramid. Imagine now the pyramid being an obelisk with a broad support and a pointed top (like the Washington Monument).

You may buy more than four spell slots per level but there must always be at least as many spell slots below that level in order to support the new amount. Further, the pyramid must be constantly building, which means that the level above must have only one less than the amount you are buying.

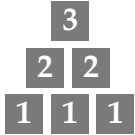

Figure 3-1.

In other words, to buy a fifth 2nd level spell slot, you must have a fifth 1st level spell slot and a fourth 3rd level spell slot.

Example of Pyramid Rules: Enchanto the mage has a 3rd level spell slot, two 2nd level spell slots, and three 1st level spell slots. His pyramid is fine. (figure 3-1)

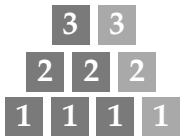

Figure 3-2.

He wants to learn a 4th level slot eventually. He must build the foundation of the pyramid so it can support a 4th level spell.

First, he buys another 1st level slot and then another 2nd level slot. He must next purchase another 3rd level slot (figure 3-2).

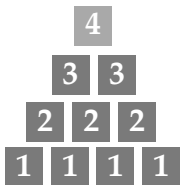

Figure 3-3.

Now his pyramid is ready for the new spell level. Imagine the pyramid as needing the proper support for the 4th level spell has been made by making sure there are two 3rd level spell slots below. (The foundation for the two 3rd level slots was made when he had three 2nd level slots, and so on down the line.)

He can buy his first 4th level spell slot (figure 3-3).

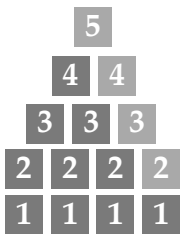

Figure 3-4.

If Enchanto wants to buy a 5th level slot, he can do so without having to buy any more 1st level slots because four is the maximum required. He must support the 5th level slot by buying a 2nd, 3rd, and a 4th in that order to make the pyramid (figure 3-4)

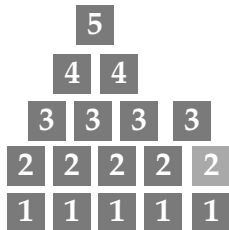

Figure 3-5.

Enchanto now has a perfect pyramid again. If he wants, he can stop buying 2nd level spells now, as four is the maximum required. His pyramid will then progress with the purchase of a 3rd level spell slot, and then a 4th, 5th, and then his first 6th level spell slot.

If Enchanto has all the slots listed in the pattern above (figure 3-4) and then decides that he wants a fifth 2nd level spell slot, he must first buy another 1st level slot and a fourth 3rd level spell slot to support the 2nd level spell slot. After he buys the 1st and 3rd level spell slots, he can get the 2nd level spell slot he wanted (see figure 3-5).

The pyramid must continue to be built and it must be built from the ground up! Note that the pattern is very set as to which spell slots

have to be next purchased unless you wish to buy more than four spell slots of any one level.

There is potentially no limit to the number of spells per level as long as this progression is maintained. If Enchanto wanted to keep "bottoming out" his pyramid, he could end up with a pyramid that has nine 1st level spells, eight 2nd level spells, seven 3rd level spells, and so on up to one 9th level spell.

Skill Costs

Below and on the following pages are the charts listing the Build Point costs of skills. Each skill has four cost columns associated with it: F (fighter), R (rogue), S (scholar) and T (templar). Note that all classes may buy any skill; they just might have to pay more Build Points.

When buying skills, you should be aware of the prerequisites as well. For instance, to buy *WEAPON PROFICIENCY*, you must first have a weapon skill to be proficient in and four *CRITICAL ATTACK* skills. To learn how to cast celestial spells, you must first know how to *READ AND WRITE* and *READ MAGIC*.

A good way to design your character is to imagine him or her at a higher level and work backwards. Figure out which skills you would like to have and how many Build Points you will have to spend for the skills. Try it with different classes to see which costs the least.

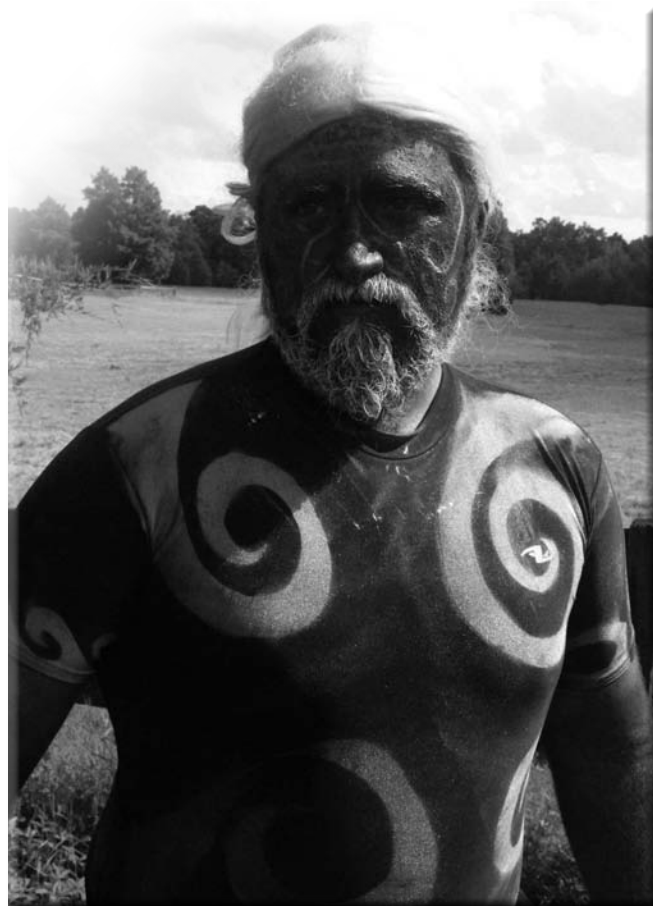



<i>Racial Abilities</i>					
<i>SKILL NAME</i>	<i>F</i>	<i>R</i>	<i>S</i>	<i>T</i>	<i>PREREQUISITE</i>
Barbarian Slay	10	10	10	10	Barbarian
Break Charm*	2	2	2	2	Biata, Mystic Wood Elf
Detect Celestial Magic*	2	2	2	2	Barbarian
Gypsy Curse / Remove Gypsy Curse*	2	2	2	2	Gypsy
Hobling Dodge	12	12	12	12	Hobling
Resist Charm*	3	3	3	3	Biata, Drae, Elf, Mystic Wood Elf
Resist Poison*	4	4	4	4	Dwarf, Hobling, Sarr, Scavenger
Resist Sleep*	2	2	2	2	Biata, Drae, Elf
Strong-arm	10	10	10	10	Half-Ogre, Half-Orc

<i>Magic Skills</i>						<i>Table 3-3.</i>
<i>SKILL NAME</i>	<i>F</i>	<i>R</i>	<i>S</i>	<i>T</i>	<i>PREREQUISITE</i>	
<i>SCHOLARLY SKILLS</i>						
Read and Write	6	6	3	3		
Read Magic	8	6	4	4	Read and Write	
<i>HEALING SKILLS</i>						
First Aid	4	3	2	2		
Healing Arts	4	3	2	2	Read and Write and First Aid	
<i>HARMONIC SKILLS</i>						
Manifold	9	6	3	4	Prepare Hearth	
Prepare Hearth	6	4	2	3	Level 1 Spell Slot*	

<i>Trades and Crafts</i>						<i>Table 3-2.</i>
<i>SKILL NAME</i>	<i>F</i>	<i>R</i>	<i>S</i>	<i>T</i>	<i>PREREQUISITE</i>	
Alchemy*	6	3	4	5	Herbal Lore	
Craftsman <Type>*	3	3	3	3		
Create Potion*	6	5	3	4	Any 4th Level Earth Spell	
Create Scroll*	6	5	3	4	Any 4th Level Celestial Spell	
Create Trap*	6	3	4	5	Disarm/Arm Trap	
Disarm/Arm Trap*	9	3	6	9		
Evaluate Item	6	3	6	6		
Herbal Lore	6	3	4	5	Read and Write	
Pick Locks	9	3	9	9		
Smithing*	3	4	4	4		

<i>Weapons and Armor</i>					
<i>SKILL NAME</i>	<i>F</i>	<i>R</i>	<i>S</i>	<i>T</i>	<i>PREREQUISITE</i>
Archery	6	10	15	12	
One Handed Blunt	3	4	8	5	
One Handed Edged	5	5	10	7	
Polearm	8	10	12	10	
Shield	5	10	15	7	
Small Weapon	2	2	2	2	
Staff	4	4	4	4	
Thrown Weapon	4	4	4	4	
Two Handed Blunt	6	8	12	8	
Two Handed Sword	8	12	16	12	
Florentine	6	6	12	8	A weapon skill
Style Master	10	15	20	15	A weapon skill
Two Weapons	2	4	4	4	Florentine
Weapon Master	15	18	20	18	
One Handed Weapon Master	8	9	14	10	
Two Handed Weapon Master	12	14	18	14	
Dexterity Armor*	3	3	3	3	
Wear Extra Armor*	3	3	4	3	



<i>Fighting Skills</i>					<i>Table 3-5.</i>
<i>SKILL NAME</i>	<i>F</i>	<i>R</i>	<i>S</i>	<i>T</i>	<i>PREREQUISITE</i>
Critical Attack*	3	4	6	3	Weapon skill
Weapon Proficiency*	3	4	6	6	Critical Attack × 4
Critical Slay / Parry*	10	15	20	13	Weapon Prof × 2
Master Critical Attack*	3	4	6	4	Weapon skill
Master Proficiency*	5	8	10	6	Master Critical Attack × 4
Master Critical Slay / Parry*	13	18	25	15	Master Proficiency × 2
One Handed Block	0	0	0	0	Two Handed Weapon Skill
Stop Thrust*					
1st Purchase	0	0	0	0	2 Handed Melee Weapon
Additional Purchases	2	2	2	2	Weapon/Master Prof × 2

<i>Stealth Skills</i>					<i>Table 3-6.</i>
<i>SKILL NAME</i>	<i>F</i>	<i>R</i>	<i>S</i>	<i>T</i>	<i>PREREQUISITE</i>
Waylay					
1st Purchase	6	3	6	6	Short/Small Weapon skill
Additional Purchases	6	3	6	6	Character levels × 5
Back Attack*	6	3	6	6	Weapon skill
Backstab*	6	3	6	6	Back Attack × 4
Assassinate / Dodge*	20	10	20	20	Backstab × 2

* This skill can be bought multiple times

Primary School of Magic Earth/Celestial					Table 3-7.
SKILL NAME	F	R	S	T	PREREQUISITE
Level 1 Spell Slot*	3	2	1	1	Earth: Healing Arts△ Celestial: Read Magic△
Level 2 Spell Slot*	3	2	1	1	Level 1 Spell Slot△
Level 3 Spell Slot*	6	4	2	2	Level 2 Spell Slot△
Level 4 Spell Slot*	6	4	2	3	Level 3 Spell Slot△
Level 5 Spell Slot*	9	6	3	3	Level 4 Spell Slot△
Level 6 Spell Slot*	9	6	3	4	Level 5 Spell Slot△
Level 7 Spell Slot*	12	8	4	5	Level 6 Spell Slot△
Level 8 Spell Slot*	12	8	4	5	Level 7 Spell Slot△
Level 9 Spell Slot*	15	10	5	6	Level 8 Spell Slot△
Formal Magic*	12	8	4	6	Level 9 Spell Slot

Secondary School of Magic Earth/Celestial					Table 3-8.
SKILL NAME	F	R	S	T	PREREQUISITE
Level 1 Spell Slot*	6	4	2	2	Earth: Healing Arts△ Celestial: Read Magic△
Level 2 Spell Slot*	6	4	2	2	Level 1 Spell Slot△
Level 3 Spell Slot*	12	8	4	4	Level 2 Spell Slot△
Level 4 Spell Slot*	12	8	4	6	Level 3 Spell Slot△
Level 5 Spell Slot*	18	12	6	6	Level 4 Spell Slot△
Level 6 Spell Slot*	18	12	6	8	Level 5 Spell Slot△
Level 7 Spell Slot*	24	16	8	10	Level 6 Spell Slot△
Level 8 Spell Slot*	24	16	8	10	Level 7 Spell Slot△
Level 9 Spell Slot*	30	20	10	12	Level 8 Spell Slot△
Formal Magic*	24	16	8	10	Level 9 Spell Slot

△ Spells must be bought in pyramid fashion

Production Skills

To create game items such as Weapons, Armor, Potions, Scrolls, Traps, Alchemical Elixirs, Contact Poisons, and Gas Globes, you must first buy the appropriate skill with your Build Points.

The charts in *Adventuring Gear* on page 105 show what can be made with specific skills. To actually make an item on these lists, you will have to determine the item you wish to make and then make sure that you have the Production Levels.

Every item or special item property has an associated Production Level that is required to create it. Each Game Day, a character has one Production Level for each purchase of the associated Production Skill. This is referred to as the character's Base Production Level. There are three ways to augment your production output; Trade Mastery, Materials, and Workshops, they do not change the Base Production Level.

Figure 3-6.

Base prod lvls:	20
Master lvls:	+20
Workshop lvls	+20
Material lvls	+20
Total per day Output	80 lvls

is said to have broken, rusted, or otherwise lost potency. This damage can be repaired by using production skills to issue a new tag for the item. This explains how you can still own your father's sword even though it rusts and expires every two years.

Special Abilities

If a production skill has Special Abilities, only Base

Trade Mastery: A character with ten or more levels of a single Production Skill is considered a Master of her trade, and generates one "Master" Production Level per level of overall skill.

Workshops: A workshop generates one "Workshop" Production Level per level of overall skill.

Materials: A character may also buy more refined materials at Logistics in order to increase their output at the rate of one silver per Production Level, to a maximum of their Base Production Level.

Local chapters may issue Production Components to represent these refined materials as in-game treasure or for sale by merchants in addition to or instead of using silver. One Production Component is equal to one silver for the purposes of increasing production output, but the combined increased output of silver and Production Components cannot exceed the Base Production Level.

Example: "Talon has 20 levels of create scroll so his base production level for one day is 20. Since Talon has over 10 levels of create scroll he is a master craftsman and gets 1

bonus production level per level for 20 bonus production levels. Talon spends 10 silver and turns in 10 production components at check-in for another 20 bonus production levels. Finally Talon uses a scroll workshop which allows him to create 20 bonus production levels of scrolls. Talon then uses his 80 production levels to create scrolls, this is the maximum amount of production output Talon can get with his base production level." See figure 3-6.

All production items have an expiration date. These items last 24 months after being created. The expiration date of a particular production item is known by anyone who looks at the item reads the associated item tag that goes with it. When an item expires, it



Production Levels can be used for them. If a Base Production Level is used for a Special Ability then it cannot be used to make a game item, but the use of workshops, silver, production components, or Master Levels is undiminished.

Workshops

It is possible to become more productive in making Production items if you have access to a workshop that specializes in making them. A character with a workshop can make additional Levels of items to a maximum of their Base Production Level.

- There are specialized workshops for making
- (a) alchemical elixirs, gases, and contact poisons,
 - (b) making weapons and armor,
 - (c) creating potions,
 - (d) creating scrolls, and
 - (e) making and arming traps.

Access to these workshops is found through in game means, often by way of a local guild or noble connection. Workshops are chapter specific.

Goblin Production

Goblin stamps can be used to purchase production items. They can not be used to add special abilities to items. The scale and rules

governing their use are available on the NERO National Website. These rules have been known to change, so make sure you check the NERO National Website periodically.

Skill Descriptions

Skills listed with a (*) can be bought multiple times to improve or increase the skill. Read the description carefully.

Alchemy*

Prerequisite: Herbal Lore

ALCHEMY skill allows the character to create non magical elixirs, poisons, oils, and solvents. For each time *ALCHEMY* is bought, the character gets one Production Level. *ALCHEMY* cannot be used to determine the presence of an alchemical substance or magical potion in a creature's bloodstream.

Make Elixirs, Contact, & Gas Poisons

The list of substances, that can be made with the skill *ALCHEMY* and their Production cost is in the *Adventuring Gear* chapter.

Mix in Item (requires 1 level of Alchemy)

Allows you to mix an ingested substance into a food or drink. Anyone can use an ingested substance if not mixed in food or drink. (In other words, anyone can drink a *CURE LIGHT DAMAGE* elixir straight from the bottle, but you must have *ALCHEMY* 1 in order to mix that elixir into a drink or food.)

Handle Poison (requires effect levels of Alchemy)

To employ a gas or apply a contact substance other than *VORPAL COATING* requires at least the purchase of a number of levels of the *ALCHEMY* skill equal to the production level value of the poison being used. Note that all gas packets must be orange to differentiate them from spell packets (which cannot be orange).

Assassinate / Dodge <hand>*

Prerequisite: 2 Backstabs per purchase

This skill enables the character to deliver a dangerous stealth attack once per day for each time the skill is bought. *ASSASSINATE* may be used with any weapon capable of being used by the character, but must be purchased for a specific hand.

Assasinate: An *ASSASSINATE* can only be delivered from behind.

A *PARRY*, *MAGIC ARMOR* or similar effect can protect from an *ASSASSINATE*. In order to use an *ASSASSINATE*, you must be behind the victim and able to see his or her shoulder blades. You cannot reach around from the front or from the side. If the blow does not land on the back of the target's torso, legs, or arms, then it will have no effect. By its nature, an *ASSASSINATE* cannot be held active nor may it switch targets; it can only be used for one strike. It does not have to be by surprise.

An *ASSASSINATE* does 100 damage and is called as "100 <weapon type><damage type> Assassinate." For example:

"100 Normal Assassinate", or "100 Magic Lightning Assassinate"

Blade Fury: Every fourth *ASSASSINATE* a character has deals 200 damage instead of the normal 100. No PC may augment this number by any means.

Dodge: A *DODGE* may be used in place of an *ASSASSINATE*. This use of the skill allows the character to call “*dodge*” instead of being affected by any single *NERO* weapon or packet attack for each time the skill is purchased. It does not protect against traps (except for weapon traps), or Killing Blows. *DODGE* cannot be used if a character is completely immobilized, such as when Confined or Paralyzed.

ASSASSINATES and *Bladefurys* will always do full damage to a creature with a threshold or a damage cap.

ASSASSINATE/DODGE can be bought after every two *BACKSTABS*.



Back Attack* <weapon> <hand>

Prerequisite: A Weapon Skill

This skill allows the character to do two extra points of damage against any one opponent from behind for the duration of the battle (which is defined as “*Line of Sight*” as per spells) once per day for each time the skill is taken. This bonus applies to any weapon in which the character has the skill. When the skill is bought, the player must specify for which hand the skill is to be used. You must be behind and able to see the victim’s shoulder blades to do a Back Attack; you cannot reach around from the front or from the side.

After a character has earned the fourth *BACK ATTACK*, the character can trade them in and buy a *BACKSTAB* (see below). The character may then begin learning *BACK ATTACKS* again.

For example: Nira the Rogue has worked her way up to the point where she has learned one Backstab. She now does +2 damage for every hit from behind with any weapon she can use. She then begins to learn Back Attacks again. For each Back Attack she learns now, she can do another two points of damage to one opponent, so when she uses these skills, she does +4.

Backstab* <weapon><hand>

Prerequisite: 4 Back attacks traded.

This skill allows a character to do an extra 2 points of damage to any foe they can hit in the back while standing behind the person. You must be behind the victim and able to see the victim’s shoulder blades to do a *BACKSTAB*; you cannot reach around from the front or from the side. The player must specify for which hand the skill is to be used at the time it is purchased.

The skill can be bought multiple times and the effects are cumulative. This skill can be used with any weapon with which the character has the skill.

Barbarian Slay

Prerequisite Race: Barbarian

This skill allows a Barbarian the use of one Slay, as described in the entry for *CRITICAL SLAY/PARRY*. This skill may only be purchased once, and does not count against the character’s limit of *CRITICAL SLAY/PARRY* purchases.

Break Charm*

Prerequisite Race: Biata, Mystic Wood Elf

With this skill, a Biata or Mystic Wood Elf can break active charm effects on another

creature once per day for each time the skill is taken. The effects included are *CALM*, *CALM ANIMAL*, *CHARM*, *CHARM ANIMAL*, *SHUN*, *SHUN ANIMAL*, *FEAR*, and *VAMPIRE CHARM*. It does *not* include *ENSLAVEMENT*.

You must be able to touch the charmed person, have his or her attention, and spend one full minute of role-playing conversation with the charmed victim. If you perform any other skills during this minute, if the charmed person is attacked, or if the conversation is halted, then the *BREAK CHARM* is unsuccessful. Attempting this action on a character that had not been charmed will still result in the ability being used for the day. This ability does not affect (nor is it affected by) any Spell Defenses.

You cannot use this skill upon yourself.

Celestial Magic Spell Slot <level>*

Prerequisite: Read Magic, and Pyramid stye.

This skill allows the character to cast Celestial Magic spells of the level purchased. This skill is a spell slot as described in the chapter on the Skills System.

Craftsman: <type>*

This skill represents a trade or source of income. It cannot be used to give a character any extra skill in-game. It is sometimes used as a way to give some useful information by the Plot Committee. For instance, if a character takes “*Craftsman: Historian*” it is up to the character to learn the history in game so that she can talk about it to others and they may or may not be given some useful information about a storyline being produced by the plot committee at the discretion of the plot committee.

Craftsman skills must be professions that would provide an income. For every Craftsman skill bought, a character will receive two silvers at check-in for each game-day. A character that has 10 levels in a particular craftsman skill is considered a “*master*” and is rewarded for their expertise. They begin earning 5 silver pieces per day per level, rather than the usual 2 silver pieces per day per level. Master craftsmen, if the trade is honorable, may be addressed with the title ‘*Master*’ by social convention. Examples of craftsman professions include (but are not limited to)

Actor, architect, artist, astrologer, baker, bard, brewer, butcher, calligrapher, candle-maker, carpenter, farmer, farrier, forester, historian,

hunter, jeweler, masseuse, merchant, musician, sage (specify field of study), sailor, scout, scribe, tailor, tavern keeper and undertaker.

Create Potion*

Prerequisite: Earth Magic Spell Slot <Level 4>

This skill allows the character to create an earth magic based potion. Each purchase of this skill allows the character to make one Production Level worth of potions. The character must have a spell slot of the level to be made. Note that not every spell can be made into a potion, there will be a **P** in the heading for spells able to be made into potions.

Create Scroll*

Prerequisite: Celestial Magic Spell Slot <Level 4>

This skill allows the character to create a celestial magic based scroll. Each purchase of this skill allows the character to make one Production Level worth of scrolls. The character must have a spell slot of the level to be made. Note that not every spell can be made into a scroll, there will be an **S** in the heading for spells able to be made into scrolls.

Create Trap*

Prerequisite: Disarm/Arm Trap

A character with this skill can make traps as described in the chapter on Traps and Locks. Making a trap costs Production Points and falls under the rules set forth in the Chapter *Adventuring Gear* on page 105.

Critical Attack <weapon> <hand>*

Prerequisite: A Weapon Skill

This skill allows the character to do one extra point of damage against any one opponent for the duration of the battle once per day for each time the skill is taken. Battle duration is defined as "Line of Sight" as per spells.

This bonus applies only to either the right or left hand and a particular weapon in that hand.

After a character has earned the fourth **CRITICAL ATTACK**, the character can trade them in and buy a **WEAPON PROFICIENCY**. The character may then begin learning **CRITICAL ATTACKS** again.

Example: Inar the Fighter has worked his way up to the point where he has learned Weapon Proficiency. He now does +1 damage for every hit he does with a Longsword. He then begins to learn Critical Attacks again. For each Critical Attack he learns now, he can do another point of damage once per day per opponent, so when he uses these skills, he does +2.



When he has enough build points, he can buy Weapon Proficiency again and he will do +2 constantly. He may begin buying Critical Attacks again to do +3 once a day for every Critical Attack he has learned.

Critical Slay / Parry <weapon> <hand>*

Prerequisite: 2 Weapon Proficiencies per purchase

This skill enables the character to either swing a large amount of damage, or avoid a physical attack once a day for each time the skill is bought. A **CRITICAL SLAY/PARRY** may be bought once for every two full **WEAPON PROFICIENCIES**. Both of these skill uses the same handedness rules and specific weapon rules as **CRITICAL ATTACK** and **WEAPON PROFICIENCY**.

Anyone with multiple **CRITICAL SLAYS/PARRIES** can expend a **PARRY** while they have an active slay without expending the active slay.

Critical Slay: does 100 damage and is called as "100 <weapon type><damage type> Slay." For example:

"100 Silver Ice Slay"

A **CRITICAL SLAY** will always do full damage to a creature with a threshold or a damage cap.

Before using a **CRITICAL SLAY**, the character must call out "Prepare to die!" (this is an OOG statement and can be made even while silenced). The Slay is considered used as soon as the statement is made. The Slay will be active until the blow is landed, or five minutes pass. If the blow is landed, the Slay damage can be negated by other game defenses such as **PHASE**, **DODGE**, **PARRY**, **MAGIC ARMOR**, etc. The 5 minute time period cannot be shortened by any other means, including having the weapon disarmed or destroyed, calling a defense, killed and then Life'd, falling unconscious, etc.

When engaging new opponents you must announce "Active Slay" this is an OOG statement and can be made even when silenced.

A player hit by a Slay who does not die from the Slay must announce that the Slay was successful by saying "Hit" or role-playing appropriately. This informs the fighter using the Slay that he or she must then begin calling regular damage again.

Blade Fury: Every fourth **CRITICAL SLAY** a character has deals 200 damage instead of the normal 100. No PC may augment this number by any means.

Parry: may be used in place of a **CRITICAL SLAY**. This allows the character to call "Parry" instead of being affected by any one physical attack delivered by a NERO weapon or packet. Parry can only be used to block physical attacks from boffer weapons, arrows, and attacks with the word "Physical" in the incant. i.e. Parry can block a weapon trap, but not an explosive trap. It cannot be used to block spellstrike.

You may not use a **PARRY** if you do not have a weapon in your hand or if your weapon is not free. A Two Handed weapon must be held in both hands to be able to use a **PARRY**. You may Parry a blow that strikes another character provided you are able to touch



the victim of the attack with your weapon. A character using the *PARRY* skill calls out "Parry" in response to the attack being negated. If Parrying for another, a character calls out "Parry for <X>" where X is the name or race of the character you are Parrying for.

Detect Celestial Magic*

Prerequisite Race: Barbarian

This skill enables a Barbarian to detect magic (as the spell) once a day for each time the skill is bought. It will only be able to determine the presence of Celestial magic upon an object, an item, or on themselves but will not work on other characters..

To use, the Barbarian holds up to 5 items in their possession for an uninterrupted minute while role-playing their examination. After the minute, the owner of the item then informs the Barbarian if they are Celestial in nature or not.

Dexterity Armor*

The skill dexterity armor represents a characters ability to absorb damage by learning to roll with blows. It may be bought a maximum of ten times and each time purchased will add two points of armor to the characters total. A character must be "well costumed" to use this skill see "Costumes" on page 121. Dexterity armor is damaged after any physical armor is depleted. To refit dexterity armor a character must take 60 seconds to stretch and role-play shaking out their tightened muscles, they must be in a state where they are capable of moving and using skills in order to refit dexterity armor. The refit of dexterity armor is done separately from the refit of physical or arcane armor. To use dexterity armor you must be able to move. If you are unable to move you lose the protection

of your Dexterity armor until you regain mobility. This does not restore any points lost before the protection was lost. Dexterity Armor will stack with Physical or Arcane Armor up to a character's wear point total see "Wear Points" on page 105.

Disarm / Arm Trap

This skill allows the character to attempt to disarm or set a trap. It does not guarantee success. You must have this skill to even attempt to disarm or set a trap. You may not even cut an obvious trip wire without this skill. Traps may only be set in the presence of a marshal. This skill is difficult to use without some simple tools such as a knife, candle, probe, etc. See "So You Want to Be a Thief?" on page 94 for advice.

Earth Magic Spell Slot<level>*

Prerequisite: Healing Arts

This skill allows the character to, cast Earth Magic spells of the level purchased. This skill is a spell slot as described earlier in this chapter.

Evaluate Item

This skill enables the character to place a fairly accurate monetary value on any in-game tagged items that are not production items, formal components or magic items seen. This skill does not identify whether or not the item is magical. In most chapters, you will receive an item identification sheet which will allow a player with this skill to determine the value of an item being evaluated.

First Aid

First Aid allows the user to stabilize a dying creature with a metabolism, bringing the recipient to zero Body Points. The person will regain consciousness in one minutes with one body point.

This skill will have no-effect on a creature that is not currently within the first minute of the death countdown while a creature is dying. Note that the skill *HEALING ARTS* is needed to determine if the creature is dead.

The skill requires a full uninterrupted minute, in which time the person applying the *FIRST AID* can perform no other game skills. Just like any game effect in NERO, if this skill does not affect you, you must call "no effect" when this skill is first applied. At the end of the one minute count the person applying *FIRST AID* must call "Stabilize" to indicate that the skill has completed.

If a character is interrupted while giving *FIRST AID* on, then the death countdown continues where it left off when the First Aid was started. You cannot *FIRST AID* more than one person at a time. The one minute count represents the he time it takes to bind wounds and stop bleeding. The player with this skill should role-play dressing wounds with bandages when applying *FIRST AID*.

Florentine

Prerequisite: A weapon skill

This skill allows the character to hold and use two weapons in combat, one in each hand. Neither weapon can be a two handed weapon, and one of the weapons must be of the *SMALL WEAPON* type. If different damages are being delivered with each weapon, then you must call out the appropriate damages when swinging the weapons.

Formal Magic <school>*

Prerequisite: <school>Level 9 spell slot

This skill allows you to read and use formal magic scrolls of your particular school (Earth or Celestial). This skill does not require the building of a second spell pyramid, but is bought in a linear fashion like *CREATE SCROLL*. This skill will allow you to identify the level and type of formal

A player may cast school of magic per of formal magic

See the Formal sections for more

magic components. one cantrip of their day for each level they possess. Magic and Cantrip details.



Gypsy Curse / Remove Gypsy Curse*

Prerequisite Race: Gypsy

For each time this skill is bought, a gypsy may bestow or remove one *GYPSEY CURSE* per day. A gypsy may not bestow a curse on another unless he or she feels that the offending being has somehow greatly insulted them or threatened their well being. Be warned that there is a strong cultural bias among the gypsy tribes about removing other gypsies' curses without express permission from the curser or the tribe's bandoleer. This curse is intended to entertain through humor or drama. If it becomes overly burdensome or embarrassing out-of-game, it is not entertaining. At the time the Curse is cast, a player who would suffer out-of-game embarrassment or difficulty with role-playing the Curse may negotiate out-of-game for a different Curse. However, he or she must eventually accept one of the Curses listed below.

In order to bestow a Curse, the gypsy must be able to see the victim and must be able to speak. Note that this skill is not packet-delivered. You may not bestow a Curse if Silenced, unconscious, or blindfolded. The gypsy can even be bound or magically held and still be able to cast a Curse as long as can still talk and can still see the victim. The Curse will pass through a *CIRCLE OF POWER* or any other magical barrier since the curse itself is not magical.

The Curse takes effect immediately upon the completion of the Curse verbal. The victim has to hear the Curse being given by the gypsy. (Unconscious victims cannot be Cursed.) The effects aren't noticeable until the victim is given all applicable props, instructions, etc. Do not call a Hold!

The Curse will remain in effect until removed by a *REMOVE GYPSEY CURSE* or the resurrection of either the gypsy or the victim.

In order to remove a Curse, a gypsy must simply touch the Cursed character and state "Your Curse is Removed." The Cursed character must be willing and conscious. Note that removing a Gypsy curse uses one of the character's *GYPSEY CURSES* for the day. It may also bring down the wrath of other gypsies if it was removed without their permission! One *REMOVE GYPSEY CURSE* will rid the victim of all active *GYPSEY CURSES*.

Ideally, removal of the Curse should be role-played out with the kind of great theatrical spectacle that gypsies love. Lots of bell ringing, incense burning and requiring the person who is having the Curse removed walk backwards or do other silly things fits right in with the gypsy character even if these things do not actually remove the Curse.

Spell defenses do not block *GYPSEY CURSES*, nor can they be *DODGED* or *RESISTED*. *GYPSEY CURSES* are not magical, and so cannot be removed by the spells *DISPEL MAGIC* or *REMOVE CURSE*, or even the *DESTROY MAGIC* effects of Formal Magic. Gypsy verbals are unlike spell verbals in many ways. First of all, they are not disrupted by combat damage taken. Second, they all begin with a little personalized prefix of the gypsy's choice, such as "May a thousand ills befall me if . . .",



"May my favorite horse break all his legs if . . .",

"May I die a long and painful death if . . ."

and so on. Gypsies are encouraged to come up with their own colorful prefixes.

GYPSY CURSES are all role-playing Curses only! The Cursed player should not allow the Curse to hinder combat abilities in any way! The Curse is not intended as a combat effect.

The Cursed player should try to act out the effects of the Curse as often and completely as possible. The Curse is intended as a nuisance and a hindrance.

The following Curses are allowed and no others:

Uncontrollable Action

Phrase: "(Individual prefix) if you do not _____ with every thing you do and say!" Fill in the blank with some inconsequential but annoying action like the following: Rhyme, bark, laugh, jump, sing, sneeze, skip, cough, whistle, burp, limp, trip, spin, cry, etc.

Effects: The Cursed character must attempt to make all sentences rhyme, will constantly trip, giggle or sneeze uncontrollably, or will otherwise abide by the requirement of the curse.

Deformities

Phrase: "(Individual Prefix) if you do not _____!" Fill in the blank with something along the following lines: Grow a pig's tail, grow warts upon your face, sprout the mane of a lion, etc.

Effects: The player must wear the appropriate makeup or mask to simulate the change of appearance.

These items must be supplied by the gypsy bestowing the Curse. A player may refuse to wear a mask or appendage if they feels it may be a hindrance in combat or a safety hazard, and can refuse to wear makeup in the case of allergies or similar reasons. In these cases, the gypsy may replace the Curse with another from the Curse list,

such as an Uncontrollable Action or Personality Change.

A Deformity curse may not be used to simulate the appearance of another race or monster! (no vampire fangs, no elf ears, no ghoul's claws, etc.) It may only be used to simulate the features of real life animals or deformities. No such deformities can ever be used offensively as weapons. Also, this Curse cannot be used to disguise someone so that they can commit crimes without being identified. Anyone affected by the Curse will still be easily recognizable as their character.

Personality Changes

The following two Curses can affect how your character thinks or acts in-game. It is entirely up to the affected player to decide how to properly role-play a given Curse, not the gypsy who

bestowed it.

Phrase: "(Individual Prefix) if you do not help those less fortunate than yourself!"

Effects: The affected character will attempt to aid any non-hostile player they see in trouble or that requests help.

Phrase: "(Individual Prefix) if you do not become the opposite of yourself!"

Effects: The affected character should take some important facet of their personality and reverse it.

A greedy character may become a philanthropist, a cowardly character might charge bravely into conflict, and a normally peaceful and reasonable character might become aggressive and short-tempered. This Curse does not act as a *CHARM*; it does not necessarily turn the antagonistic Cursed victim into the gypsy's best friend. Remember, it is the affected player's choice as to how his or her character's personality is affected by this Curse.

Healing Arts

Prerequisite: Read & Write + First Aid

This skill, which represents basic medical knowledge, is required to learn any earth magic spells.

A character with *HEALING ARTS* can determine if someone is diseased, sleeping, paralyzed, dead, dying, unconscious, or merely faking injury upon examining them. The exact extent of injuries can be determined as well.

In order to use this skill, the person must touch the subject and role-play an examination. The person states "Healing Arts" and then asks an out-of-game question to which the subject must respond. The amount of time it takes to perform the examination is determined by the length of the questions being asked and the

answers given but in no case less than three seconds.

These out-of-game questions can only include the following:

- 1) How many Body Points are you down?
- 2) Were you waylaid?
- 3) Are you diseased?
- 4) Are you sleeping?
- 5) Are you paralyzed?
- 6) Are you regenerating?
- 7) Are you unconscious (at zero body)?
- 8) Are you dying (at -1 body)?
- 9) Are you dead?
- 10) How much time until you <wake up, become conscious, become unparalyzed, die, resurrect>?

You may not ask questions like the following: What is your maximum amount of Body Points? Were you killed by necromancy? Were you killed by celestial spells? Were you poisoned? Was that guy running away the one who killed you?

The conscious recipient knows that the "diagnosis" is being done. You cannot use *HEALING ARTS* on a conscious person without their knowledge. A conscious person can prevent *HEALING ARTS* from being performed unless helpless.

This skill also allows the user to quickly identify a magical potion. This process must be role-played accordingly and must take at least three seconds.

Herbal Lore

Prerequisite: Herbal Lore

This skill is a prerequisite to creating any alchemical substances. It allows the user to detect the presence of and identify an alchemical substance. This process must be role-played accordingly and must take at least three seconds. Once detected, the user can spend one minute of role-playing to remove poison from food or drink, destroying it in the process.

This skill cannot be used to identify blood types, detect the presence of poison in the bloodstream, identify a type of monster or a race from a blood sample, or otherwise do modern chemical observations.

Hobling Dodge

Prerequisite Race: Hobling

This skill allows a Hobling the use of one *DODGE*, as described in the entry for *ASSASSINATE/DODGE*.

This skill may only be purchased once, and does not count against the character's limit of *ASSASSINATE/DODGE* purchases.

Manifold

Prerequisite: Prepare Hearth

The skill manifold allows a character to augment certain spells by means of a brief performance. This multiplies the number of targets the caster may affect with those spells.

To manifold a spell it must be cast within a hearth as defined by the skill *PREPARE HEARTH*. Being within this Hearth allows the character who prepared it to tap into deeper powers of magic and extend the number of targets certain spells can affect. To manifold a spell the character must gather everyone the spell is to be cast on around them, each target must be fully within the hearth and within reach of the caster.

The caster must cast the spell in a manner reflecting his drawing upon deeper magics. He may do this through song, litany chanting, or recital of verse. To manifold a spell or to cast in continuously the caster must create original lyrics for singers or poems for orators. Each of this type of spell they wish to learn must have its own lyrics

or poem and be recorded in the player's song book. The lyrics or poem must have meaning which is related in content to the spell being cast. The lyrics must be in English and have at least four lines per level of the spell. The caster may choose to add extra lyrics to the end. After the required lyrics or poem the character must state the full incant for the spell. The entire song or poem must take at least two seconds per stanza to perform. A song or poem can be longer for artistic purposes. The lyrics or poem and any tune used to perform the lyrics must be in game, in period, and must relate to the magical effect. Tunes that are familiar to popular or classical culture, such as the William Tell Overture, Toccata & Fugue, or Yellow Submarine must be avoided.

The entire performance of the lyrics or poem should be reasonably sonorous. It should substantially match the song as written in the player's song book. Some minor variation is allowed, as with any sort of performance, as long as the performance is reasonably smooth and appears correct. Speed singing, poor accompaniment, poor vocalization, or clearly fumbled words will invalidate the casting of the spell. It is permissible for PCs and NPCs to use the same

lyrics though it is preferred that for richness of the game each player using this skill should try to have their own unique lyrics.

Once the recitation or song is complete the caster must touch cast the spell on each target using the complete incant. The maximum number of targets that can be affected by a manifolded spell is equal to the number of spell slots of the appropriate school of magic the character has to a maximum of six. This can be modified as follows. If the caster is accompanied by music the number is increased by one. If the caster has additional characters singing or reciting in chorus with them who are capable of manifolding the same spell the number is also increased by one. This brings the absolute maximum number who can be affected by a single manifolded spell to eight.



If a target is not touched after the spell, or the target does not remain within arm's reach, or the target leaves the hearth, that target is not affected. The caster is subject to spell disruption while casting the manifolded spell and the chorus or accompaniment can be disrupted as per rules for spell disruption as well. If the caster uses an instrument, that playing is considered to be part of the casting and both hands can be used to play.

Spells which may be Manifolded will have an  in the upper line of their spell description.

Master Critical Attack <hand>*

Prerequisite: A weapon skill

This skill allows the character to perform a *CRITICAL ATTACK* with any weapon in which the character has the skill. Handedness must still be declared but weapon type is not. When buying this skill, you must upgrade any regular *CRITICAL ATTACKS* that you already have.

Master Critical Slay / Master Parry <hand>*

Prerequisite: 2 Master Proficiencies per purchase

This skill allows the character to perform a *CRITICAL SLAY* with any weapon in which the character has the skill. Handedness must still be declared but weapon type is not. When buying this skill, you can upgrade any regular *CRITICAL SLAY/ PARRY* that you already have.

Master Proficiency <hand>*

Prerequisite: 4 Master Critical Attacks traded

These more expensive proficiencies can be used with any weapon in which a character has the skill. The character still must declare

handedness but need not declare weapon type.

MASTER PROFICIENCIES are bought in a manner similar to normal *PROFICIENCIES*. *MASTER PROFICIENCIES* may be combined with normal *PROFICIENCIES AND BACKSTABS* for determining damage.

You can upgrade your *PROFICIENCY* to a Master by paying the difference in Build Points.

Pick Locks

This skill allows the character to try to pick locks. It does not guarantee success.

In order for this skill to be useful, a player should have a set of picks or tools (not provided by NERO). See "So You Want to Be a Thief?" on page 94.

Alternate Lock Picking: In some areas of the world it is illegal out-of-game to possess any tools designed for opening locks. As a result the local chapter has the option of using an alternative method of picking locks.

To open a lock using this method takes 1 minute of uninterrupted concentration. In addition, a chapter may require you to solve some sort of puzzle. You must have a suitable lock-pick phys-rep at least 2 inches long that can be as simple as a straight piece of metal but cannot be capable of actually opening a lock or you may find yourself in violation of local laws. The character must have the lock-pick phys-rep in their hand and place both hands on the lock. Nothing else may be in the character's hands.

Prepare Hearth

Prerequisite: <school>Level 1 spell slot

This skill allows a player to attune a room for use in Manifolded spells. The room to be used follows some rigid guidelines. The room must have a roof that would keep out rain, and must have well defined boundaries that are under that roof. Those boundaries need not be walls, but they do need to be immobile. The Hearth will not extend outside any doorway or passage that leads from the room. To attune a room the caster must pace the boundaries of the room staying within arms reach of each wall and holding their arm extended palm out toward the wall. They must pace the room at walking speed and at no time during the pacing of the room may they use any other skills or take body damage or the preparation will fail. If the caster cannot do this due to some danger or obstruction then the room cannot be prepared as a Hearth. Once a room is prepared, it will last until the character who prepared it leaves its confines, dies, is affected by a *DISPEL MAGIC*, or the end of the event. Multiple characters can prepare the same area, but each must do so in order for them to manifold spells within its confines.

Read and Write

A character without this skill will not be able to read even the simplest written signs, scrolls, numbers or maps. With this skill, a character can read anything except magical writing.

It does not allow a character to read foreign



languages they do not know, nor does it allow them to decode coded messages. It does allow the character to try to decode or translate the message.

Read Magic

Prerequisite: Read and Write

This skill is required for anyone wishing to learn celestial magic spells or to read and cast magic scrolls.

With this skill, a character can read magic scrolls up to the character's highest level of celestial spell ability plus four. Thus, if you have the skill *READ MAGIC* and have no celestial spells, you can read up to and including 4th level magic scrolls. If you know one celestial spell level, you can now read scrolls up to and including 5th level, and so on. Remember that to cast a spell from a magical scroll, you must actually hold the scroll before you, have enough light to be able to read it, actually read the scroll, say the verbal incantation out loud, touch the spell packet to the scroll, and then throw the spell packet.

This skill also allows the user to quickly identify a magic scroll simply by reading it.

Resist Charm*

Prerequisite Race: Biata, Drae, Elf, or Mystic Wood Elf

With this skill, a Biata, Drae, Elf, or Mystic Wood Elf, can resist one charm effect per day for each time the skill is taken. The skill *RESIST CHARM* only works on these listed effects: *CALM, CALM ANIMAL, CHARM, CHARM ANIMAL, SHUN, SHUN ANIMAL, FEAR, ENSLAVEMENT, AND VAMPIRE CHARM*. No other effects from the rule book can be resisted by this skill. For example, *BERSERK* or *Feeblemind* effects cannot be resisted with this skill.

If the charm effect is from a spell or poison that would normally be stopped by a spell defense, then the spell defense must be used before the *RESIST* or the protective will be lost. You cannot save your spell defense because you would not have been affected by the spell. This skill can be used to protect against ingested potions and elixirs if desired.

In order to use this ability, the player must call "*Resist*" within 3 seconds when struck by the charm effect. The character must be conscious to use this skill. You may not pretend to be affected by the charm effect and then call "*Resist*" later. Thus it is always obvious to all observers that the charm effect has not worked.

Resist Poison*

Prerequisite Race: Dwarf, Hobling, Sarr or Scavenger

With this skill, a Dwarf, Hobling, Sarr or Scavenger can resist one poison effect for each time the skill is bought. This includes all alchemical substances (including ingested elixirs) as well as all Monster Attacks that use the word "*poison*."

If the poison effect is one that would normally blow a spell defense, then the spell defense must be used before the *RESIST* or the protective will be lost. You cannot save your spell defense because you would not have been affected by the poison.

In order to use this ability, the player must call "*Resist*" within 3 seconds when struck by the poison attack. The character must be conscious to use this skill. You may not pretend to fall affected and

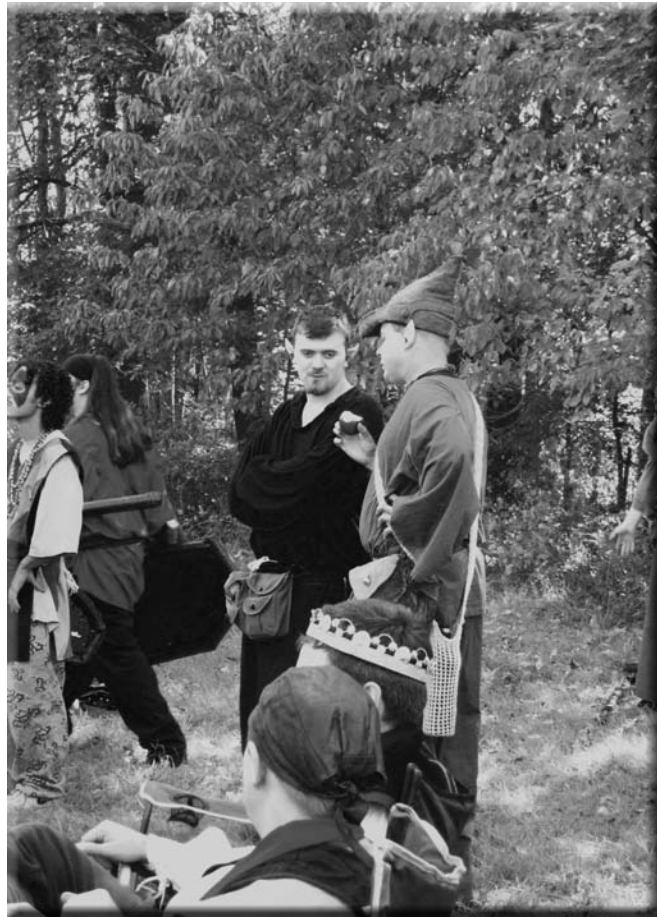

then jump up and say "*Resist!*"

Resist Sleep*

Prerequisite Race: Biata, Drae, Elf

With this skill, a Biata, Drae, or Elf can resist one sleep effect per day for each time the skill is taken. This does not include *WAYLAY*.

If the *SLEEP* effect is from a spell or poison that would normally be stopped by a spell defense, then the spell defense must be used before the *RESIST* or the protective will be lost. You cannot save your Spell Defense because you would not have been affected by the spell. This skill can be used to protect against ingested sleep potions and elixirs if desired.

In order to use this ability, the player must call "*Resist*" within 3 seconds when struck by the *SLEEP* effect. The character must be conscious to use this skill. You may not pretend to be affected by the *SLEEP* effect and then call "*Resist*" later. Thus it is always obvious to all observers that the sleep effect has not worked.

Shield

This skill allows the character to use a shield in combat. Shield use in NERO is unrealistic, as NERO shields are indestructible except through the use of effects such as *SHATTER* and *DESTROY*. To compensate for this, shield use is somewhat restricted as well. You cannot hold or carry any in game items in the hand and/or arm being used to hold a shield or weapon. This includes gas globes, magic items, weapons, etc. If you do so, any damage inflicted on

your shield or the weapon is NOT blocked and you take it as if you didn't have a shield. Worn items such as bracelets, rings, and gloves are not restricted by this rule in any way so long as they are worn properly and not carried. Attaching items to the back of a shield is completely legal so long as these items do not extend beyond the outside edge of the shield at any point or otherwise enhance the defensive value of the shield. See "Shields" on page 114 to learn more.

Smithing*

Each purchase of this skill allows for one Production Level's worth of Weapons or Armor to be made. In addition, the weaponsmith can create items with certain special properties or use certain times per



day abilities. When making, silvering, or strengthening an item, the smith must get the proper tags at logistics. You cannot use goblin points to add special properties to an item.

Making weapons

This skill works on the "Production Skills" system as detailed on in the chapter *Adventuring Gear* on page 105.

Special Property: Silvering a weapon

A silvered weapon uses the Weapon Type Silver. Silvering an existing or newly made weapon costs four Production Levels and 1 silver piece per linear inch of the striking surface of the weapon. A quiver of arrows/bolts costs 5 silver and 4 Production Levels to silver. Rendered weapons may be silvered.

Special Property: Strengthening an item

Strengthening an item allows it to withstand SHATTER and DESTROY spells and explosive traps. No item larger than a door can be

strengthened. A suit of armor can be Strengthened, but a new tag must be issued to cover the entire suit. Strengthening an item costs four Production Levels total and special Shatter Resistant components that are found in game. For each Shatter Resistant component consumed in strengthening an item, the item gains the ability to twice ever negate its own destruction from a SHATTER or DESTROY effect, which includes an explosive trap. Only up to three Shatter Resistant components may ever be consumed to strengthen an item. The holder of the item calls "Resist" to indicate that the item has not been destroyed and marks a use of the property on the associated item tag.

Special Property: Enhanced Armor

A suit of Enhanced Armor will allow you to use a higher value tag than the suit of armor phys-rep. To make a suit of armor Enhanced Armor the number of levels of production required will be double the normal to make it. An SR1 per armor location must be used in the creation of the suit. The extra points of armor gained from this technique count toward your wear point total see "Wear Points" on page 105. Enhanced Armor has an additional one point of armor per location.

Special Ability: Improving a weapon

A smith may at any time improve a weapon which adds damage to the call of anyone swinging the weapon. This bonus is not cumulative with the Formal Magic damage aura and the higher bonus only will count. The bonus will last only until the next standard reset. The smith can add bonuses by spending base production levels, as seen in Figure 3-7 which were not already used for another purpose. No smith can add a bonus greater than plus

Figure 3-7.

Bonus	Levels
+ 1	3
+ 2	9
+ 3	18

standard reset period. Rendered weapons may be Improved.

Special Ability: Rapid refit:

A smith may spend one level of base production, which was not already used for another purpose, in order to refit a suit of armor faster than normal. This effect cannot be thrown, but may be used on another person. To use this skill, the smith must have one hand free, remain stationary, and role-play repairing the armor for at least three seconds and then call "Physical Refit Armor." If the smith or the person whose armor is being repaired are struck in any way during the role-play time or before the effect has been deliver then the refit is interrupted and the skill is used.

Stop Thrust*

1st Purchase Prerequisite: 2 handed Melee Weapon

Add. Purchases Prerequisite: 2 Weapon/Master Proficiencies per

The wielder of a polearm, two handed sword, two handed blunt, or staff can use this skill against any opponent. The user swings and makes contact with the opponent and calls "Stop thrust". The target can call an appropriate defense such as a parry, dodge, or phase, but cannot block the attack with a weapon or shield.



The opponent may not advance on the user for five seconds but may still attack, run away, or defend themselves. Anyone with the skill for an appropriate weapon or weapon master gets one use of this skill for free and gains the chance to purchase another use for every two proficiencies in an appropriate weapon. This skill does not apply to non-melee two-handed weapons such as Bows and Crossbows.

Strong-arm

Prerequisite Race: Half-Orc, Half Ogre

This skill allows a Half-Orc or Half-Ogre to swing one extra point of damage with any weapon they are able to wield, including wielding two weapons at once. This skill does not confer any of the benefits of Superhuman Strength or the Endow spell, only additional weapon damage.



This skill may be purchased only once. It does not count as a Proficiency for the purposes of how many times the character may purchase *Critical Slay/Parry*.

Style Master

Prerequisite: A weapon Skill
With this skill, a character gains use of the *SHIELD*, *FLORENTINE*, and *TWO WEAPON SKILLS*. When buying this skill, you must "sell back" any skills that are included in *STYLE MASTER*.



Two Weapons

Prerequisite: Florentine

This skill allows the character to hold and use two weapons in combat, one in each hand. Neither weapon can be a two handed weapon, and one of the weapons can be no longer than a short sword. If different damages are being delivered with each weapon, then you must call out the appropriate damages when swinging the weapons.

Waylay*

1st Purchase Prerequisite: None

Add. Purchases Prerequisite: 5 character level per

This times per day skill allows the character to knock another character or monster unconscious. The victim of a *WAYLAY* will be unconscious for 5 minutes unless given an Awaken spell or potion. When you are knocked unconscious you keep your current body points.

This skill can be performed with any NERO-safe non-ranged One Handed Short weapon that the character a skill in. You must be behind and able to see the victim's shoulder blades to perform a *WAYLAY*; you cannot reach around from the front. By its nature, a *WAYLAY* cannot be held active nor may it switch targets; it can only be used for one strike. It does not have to be by surprise.

The character using this skill must call out the attack verbal by stating "Physical waylay." If the weapon is not a normal weapon (such as silvered, magical, enchanted with an elemental aura being used, etc.) then the call is still "Physical waylay."

This skill may be bought once plus one additional time for every five character levels, rounded down.

Weapon Master

This skill allows the use of all non-ranged weapons. It does not allow the use of *SHIELD*, *FLORENTINE*, or *TWO WEAPONS*. When buying this skill, you must "sell back" any skills that are included in *WEAPON MASTER*.

Weapon Proficiency <weapon> <hand>*

Prerequisite: 4 Critical Attacks traded

This allows the character to do a constant extra point of damage with one weapon for each time this skill is purchased.

A person can be proficient in as many weapons as desired, but a *PROFICIENCY* for each weapon must be bought separately.

When *WEAPON PROFICIENCY* is bought, the player must specify for which hand the skill is to be used, as with *CRITICAL SLAY* or *CRITICAL ATTACKS*. You cannot use the same proficiency to do an extra point of damage with both weapons if you are fighting with *FLORENTINE* or *TWO WEAPONS SKILLS*.

When attacking with a proficiency, you should merely call out the extra point of damage as regular damage.

Weapon Skills

The following weapon skills can be purchased. For exact descriptions of each of these weapon skills *Adventuring Gear* on page 105. Please note that Two handed weapons must be used with both hands at all times except when using the *ONE HANDED BLOCK* skill.

Archery

This skill allows the character to use a NERO safe bow or crossbow. For insurance and safety reasons, crossbows and real bows of



any draw weight are not allowed. Bows and crossbows are two handed weapons.

One Handed Blunt

This skill allows the character to wield a one handed blunt weapon. This includes Sap, Bludgeon, Short Hammer, Long Hammer, Short Mace, and Long Mace. A blunt weapon cannot be used for thrusting, and any thrust with the tip of the weapon does no damage. The weapon may be used with either hand.

One Handed Edged

This skill allows the character to wield a one handed edged weapon. This includes Dagger, Hatchet, Short Sword, Long Sword, Short Axe, or Long Axe. The weapon may be used with either hand. This skill also allows a character to wield a one handed spear, but the spear is a thrust-only weapon.

One Handed Weapon Master

This skill allows the character to use all one handed edged and one handed blunt weapons. When buying this skill, you must "sell back" any skills that are included within it.

Polearm

This skill allows the character to wield any hafted two handed weapon with a blade on the far end (a meat cleaver on a stick). This includes any two handed axes, halberds, etc.

Small Weapon

This skill allows the character to wield any small weapon, and includes Sap, Bludgeon, Dagger, or Hatchet or any other small (under 26 inch) close combat weapon. Note that the weapon must be a minimum of 12" in length. You cannot "sell back" this skill when buying the skills *ONE HANDED EDGE* or *ONE HANDED BLUNT*, although you must sell it back if you buy *ONE HANDED WEAPON MASTER*. The weapon may be used with either hand.

Staff

This skill allows the character to wield a staff. Staff use in NERO is restricted for safety reasons, so a player using a staff cannot trip people with a staff, thrust, or perform many other staff moves that are staples of staff use in real life. A staff has two edges for the purposes of *VORPAL COATINGS*. A staff is a two handed weapon.

Thrown Weapon

This skill allows a character to use hand-thrown missile weapons. All thrown weapons must be soft-sculptured or made of only pipe insulation with no pipe inside. Rocks to be used as thrown weapons must be at least 6 inches in diameter and must be made of open-cell foam, not pipe foam. Thrown weapons should not have any sharp corners on them. Spell packets may not be used as thrown weapons. Javelins may be used as thrown weapons, but one handed spears may not be thrown weapons.

Two Handed Blunt

This skill allows the character to wield a two handed blunt weapon. Note that a blunt weapon cannot be used for thrusting, and any thrust with the tip of the weapon does no damage.

Two Handed Sword

This skill allows the character to wield a two handed sword, and only a two handed sword. Any other two handed edged weapon falls under the Polearm skill.

Two Handed Weapon Master

This skill grants the character the ability to use all two handed weapons, such as *TWO HANDED SWORD*, *TWO HANDED BLUNT*, *STAFF*, and *POLEARM*. When buying this skill, you must "sell back" any skills that are included in *TWO HANDED WEAPON MASTER*.

One Handed Block

This skill allows a bow, crossbow, polearm, two handed sword, two handed blunt, or staff to block two blows with only one hand on the weapon. The third blow will *FUMBLE* the holder of the weapon as per the spell effect unless they grip the weapon's handle with two hands before the third strike. This skill cannot be used while holding a weapon or shield in the opposite hand. This skill is automatically known to anyone who purchases a two handed weapon skill.

Wear Extra Armor*

With this skill, a character can benefit from five additional armor points beyond their class limitations for every time this skill is bought, up to a maximum of 40.

magic



Magic Section



here are two methods chapters may decide between to track character spells – Memorization and Cast on the Fly. Each chapter will pick **one or the other** for their events.

Memorization

The Memorization system requires the caster to choose which spells they will cast at the start of each reset period. All casters have access to all spells when memorizing.

Cast on the Fly

The caster can select what spell he uses for each slot at the time of casting.



Spell Aura

There are two types of physical representations for spell aura; the manufactured spell orb and the traditional spell packets. Check with your local chapter so see which aura types you can use as some venues restrict one type or the other.

The spell orb is a manufactured product made of soft foam and can be no bigger than the size of a tennis ball. Soft foam balls can be purchased at most sporting good stores and toy stores. Foam balls are made by companies such as Wilson (called the Foam Flight Practice Ball) and Nerf makes a soft foam tennis ball.

Spell packets are constructed with bird seed and fabric. The bird seed should be the small variety, with no sunflower seeds or other heavy or sharp items that could hurt.

Do not use replacements! Rice can get wet and turn into a hardened ball. Rubber balls or tightly packed rubber bands will be too hard. If you are caught using something other than bird seed, you will have your packets and spell tags, if tags are used, confiscated and will lose your spells for the rest of the day.

To make a spell packet, the birdseed is placed in the center of the fabric, and the fabric is gathered around it and a small rubber band is used to bind the fabric or it can be sewn shut. Packets should be loosely packed – tight balls of birdseed can hurt!

The packet may be of any color except orange or yellow. Orange packets are used to represent alchemical gas globes, and yellow

packets are used for arrows.

A good size for your fabric is 6" x 6", and a good amount of birdseed is 3/4 tbsps. You can use different amounts but, you should never use so much material that the resulting packet cannot fit into a 35mm film canister. Packets that are larger than that will be confiscated by a marshal.

You may want to personalize your spell packets in some way by using a distinctive cloth or writing on the packets. This is a good way to make sure you can get your packets back after a battle without arguing with other spell casters about whose packets are whose.

Spell packets are visible as an opaque colored aura of energy only when held in the hand. In game they are visible but they do not produce any light. They are not in-game items and cannot be stolen, fumbled or removed.

You should not carry in your hand more spell packets than you can actually cast (although you can have plenty of extras in your pouches or pockets). If you only have 3 spells, you cannot have 42 spell packets between your fingers. You may also carry packets to represent scrolls or magic items that require a thrown packet to be thrown but those items must be readily available and not stashed away in a backpack.

Casting Spells

To cast a spell, the caster must have a spell packet in hand. The hand and arm with the spell packet in it must be "free" (Hands that are holding something else, or are tied or bound either physically or with a binding spell are not "free"). The caster must then correctly recite the verbal for the spell in a voice loud enough to be heard by a person standing next to you even if there is no one standing next to you. Within three seconds after finishing the verbal, the caster must then throw the packet at the target. The short phrase or "incantation" of the spell is spoken in plain English so the victim will know what spell has been cast. In game, these words are understood by anyone, but have a "magical effect" associated with them that makes them different from normal speech. Even though you can speak the language, you cannot "fake" a spell incantation or otherwise bluff the casting of a spell. You also cannot bluff the start of a spell incantation. If you start the incantation, the spell is used.

Spellcasters expend the power to cast a spell as soon as the incantation has begun. You cannot start the incantation for a spell, change your mind, and then still have that spell. You must wait until the next reset to restudy and to cast the spell again.

Spell Disruption

If a person takes body damage while casting a spell, the spell is disrupted. It does not work and is lost from memory. A spell can be disrupted by anything that deals body damage, including weapons, traps, or other spells. This is known as Disruption or Spell Disruption and is sometimes applicable to other types of attacks as noted in their descriptions.

Touch-Casting

Touch-casting is performed by holding a packet and placing it against the target you wish to affect. The obvious advantage to



PHASE, and RESIST) cannot be meditated back.

Schools of Magic

Whenever your character begins learning magic, either celestial or earth, you must select which of the two is your primary school of magic. The other will be the secondary, costing more build to buy. There is nothing preventing you from learning both earth and celestial magic but a separate spell pyramid must be built for each school.

Stacked Effects

Identical spells may not be stacked. No person may have a second copy of the same spell actively affecting him or her unless the spell description states otherwise. If you are hit with a second effect that isn't stackable, the call is "got it". Calling "No effect" in this situation is incorrect. This definition is extended to include all identically named NERO game effects, not just spells. Identical effects are not stackable, unless noted in the effect's description.

The following spell types have special rules regarding spell stacking.

this is that there is no chance of missing and wasting the effect. In such a case, the effect recipient may choose to "accept" the effect, thus letting it past their Spell Defenses such as *SHIELD MAGIC* or *ELEMENTAL SHIELD*. The recipient must be conscious to "accept" an effect without triggering the Spell Defences. You may never "accept" a thrown effect. The decision to accept an effect through touch-casting is made immediately after the effect is cast. This is to prevent a caster from tricking an unsuspecting victim.

The recipient of a touch-cast effect can always refuse the effect by saying "refused." This will use up the effect, but have no effect whatsoever on the recipient. Whenever attempting to touch-cast, you must abide by all NERO safe conduct rules.

Meditation

Any character may Meditate to regain use of "times per day" or "expendable" skills that were blocked by the Return <type> monster ability. To Meditate, the player must role-play deep concentration for 60 seconds, during which time they may perform no other actions including speaking, moving, or the use of any in-game skills, items or abilities. At the end of the meditation the character regains any skills or abilities lost to the effect "Return <type>." Only character skills and abilities may be regained by Meditating. (not Magic Items, Scrolls, Alchemy, etc.)

A spell-casting character may also Meditate to regain spells that missed a legal target. At the end of the meditation, the character regains the use of any thrown spells that failed to hit a valid target, as well as all spells, skills and abilities lost to the Return <type> effect.

Spell casters should not use the Meditate ability to intentionally miss their targets in an attempt to cause confusion for the NPCs. "Decoy" spells that are intentionally thrown away from the target should not be regained by Meditate. In effect, you can only get your spells back from Meditate if you were actually attempting to hit your target and missed. Spells negated by defenses (ex. *DODGE*,

Blade Effects

These effects change the damage call of a weapon. You may have no more than three blade effects active on you at any time. The following spells are blade effects *ENDOW*, *DELAYED ENDOW*, *ELEMENTAL BLADE*, *ENCHANTED BLADE*, and *SILVER AURA*. While blade effects can affect the same target, they only work one at a time.

Charm Effects

You can only be affected by one charm effect at a time. If a creature is under a Charm effect and is hit with another, the most recent one will replace the previously administered effect as long as the new effect is of equal or higher value to the previous effect. See Table 5-6 on page 64.

Ex. Durk the adventurer is Charmed by a Siren his friend Sloan casts a charm spell at him, since Charm is of equal value to the Charm on Durk, the Siren's charm effect is negated and Durk is now only charmed to Sloan.

However, if the second effect is of lower value on the chart (1 being the lowest) the first charm effect remains.

Ex. Durk the Adventurer is Charmed by a Siren, the Siren's minion casts Shun on Durk. Since Shun is a lower value than Charm, Durk calls "Got it" and take no effect to the Shun. Durk would remain Charmed to the Siren.

Target Specific

Some effects like *WITHER LIMB* or *SHATTER* have a sub-target as part of the call. This is required for spells and optional for other delivery methods such as carrier attacks or potions. If the sub-target is not specified then it is the target's choice as to which sub-target that is un-withered(*WITHER LIMB*) or un-rendered(*SHATTER*, *DESTROY*) will be affected. If no target matching the description exists, the call is "Got it". Calling "No effect" in this situation is incorrect.

Spell defenses

Spell defenses carry over from adventure to adventure. A fighter who still has a *SHIELD* spell on him at the end of a NERO adventure weekend will still have that spell at the beginning of the next weekend or module. This rule applies only to spells that are “indefinite” in duration. There can be no Wards when the game starts.

In-game, Spell Defenses are visible when they go off. It is obvious to anyone looking at you that you were protected from an attacking spell and what defense was used to negate it. You must state what the defense is at the time by saying “*Reflect Magic*” or “*Shield Magic*” for example, thus informing all observers that the spell was unsuccessful. Saying “*flash*” or “*no effect*” is not allowed. If you do not call a spell defense within three seconds of being hit, you take the effect and the defense is lost.

A spellcaster is not immune to his or her own spells, nor can they automatically dispel or deactivate their own spells, unless specifically noted in a spell’s description.

Spells such as Bless and Shield which merely add hit points do not have to be so announced.

Visible Effects

BERSERK, BIND, CONFINE, DISEASE, FEEBLEMIND, HALLUCINOID, IMPRISON, NAUSEA, PARALYZE, PIN, SILENCE, SLEEP, TAINT BLOOD, VERTIGO, and WEB, are all visible to any viewer while they are in effect, so long as they take the time to observe them (they must ask the affected player). The spells *WARD* and *CIRCLE OF POWER* are also visible, provided that the physical representation (rope, building or otherwise) can be seen and the viewer takes the time to observe them. You cannot call a Hold to determine whether any visible effects are present. The amount of time it takes to ask if your character sees the effect is the amount of time it took your character to notice the effect, and you should only ask for visible effects from a short distance away at a conversational volume.

Eldritch Power

Many of the spells call upon an energy called eldritch power. This is a type of energy that only affects beings that are alive or animated. If you cast a *FLAME BOLT* spell at someone and miss and hit a tree, the tree will not catch on fire. Nor can you use an *ICE BOLT* spell to keep your ice cream cold. These spells can only affect creatures that are alive or animated.

Reversible Spells

Many earth magic spells are reversible (for example, *CURE DISEASE* and *CAUSE DISEASE*). These spells do not have to be learned or “memorized” separately. In fact, there is no way to separate the two spells. If you know the spell *CURE WOUNDS*, you automatically also know *CAUSE WOUNDS*. You cannot “forget” how to cast necromantic spells or otherwise claim to only know one side of a reversible spell. You can decide at the moment of casting which spell effect you

will use (With proper incantation, of course). The reverse of many healing spells are necromantic, identifiable by the word “*Chaos*” in their incant. Beware however, that in many in game places laws exist against necromantic spells such as *CREATE UNDEAD*, so you’d better be ready to face the in-game consequences.



Necromancy

Is necromancy evil? Not every person on Tyrra thinks so—in fact, it is accepted and even promoted by some races and cultures. However, necromancy is illegal in most parts of the world because many people believe it draws upon the decaying and dying aspects of the earth and thus prevents the earth from acting “*naturally*.”

The most accepted in-game explanation is this: Imagine the planet going through its seasons normally from year to year. Healing spells “*go with the flow*” of this cycle and do not disrupt the orderly process of living and dying that are part of this orderly system. Necromancy “*goes against the flow*” of this cycle by tapping into the chaotic forces that are not part of this system. Creating undead, for example, requires that a spirit behave in ways that are contrary to the orderly flow of the cycle. This in-game “*theory*” has been used in the past to explain large numbers of undead randomly appearing (“*The chaos in this area is so strong that the cycle is being completely disrupted!*”) as well as aberrant weather (“*This cold wave this time of year can only be explained by too much necromancy being cast in the area!*”). Of course, there are many scholars who believe that this theory is a load of goblin dung and that bad weather and undead rising are all part of the normal cycle. It is up to you to decide as your character how you feel about the issue. Assume for game purposes that there are many learned treatises on both sides and that people have been arguing the point for many hundreds of years.



Elemental Planes

There are twelve main elemental planes which exist across powerful dimensional boundaries. The world of Tyrra is made up of the combination of these elements and their intersections. Please see the Tyrran Cosmology document at NeroLarp.com for more information, but it is important to note here that each of the twelve elemental planes has an associated damage type: a power it uses to harm opponents. These planes and their associated damage types are as follows:
 Planes – Life, Death, Order, Chaos, Dream, Reason, Light, Darkness, Earth, Air, Fire, and Water.
 Damage Types, in order – Essence, Destruction, Order, Chaos, Dream, Reason, Light, Darkness, Stone, Lightning, Fire, and Ice.

Illegal Skills and Powers

No character can ever use a plot given power to gain information about a PC’s actions after the fact. This includes approved spells and skills such as *DREAMVISION* as well as other abilities such as

clairvoyance, clairaudience, tracking or scrying of any manner.

If a character wants to know what was said or done by a PC first hand, he must actually be present at the time of the action. Plot will never provide this information via one of the listed abilities, or through any similar means, and a PC can never claim to have known it due to ESP or other special abilities after the fact.

Formal Magic Overview

The following pages is a brief introduction to the Nero Formal Magic System. For a full explanation of the rules see www.nerolarp.com for the Nero Formal Magic Packet.

The system may be modified from time to time by NERO International.

Scrolls may not contain modifications or flaws of any kind, except to make the scroll unable to be copied or destructible. The scrolls listed here may not be changed in any way. If used, they must be used exactly as written. Urgent questions and interpretations of these rules will be left to the local Formal Magic marshal.

Characters who have learned a ninth level spell can then start learning Formal Magic skill levels. Once a character has reached this point, they often give themselves the title of "Wizard." Some Wizards add a personal bit to this title so that the entire title might be "Wizard of Earth Magics" or "Wizard of Might and Power" or "Wizard of Life Healing." It is up to your character to decide how pretentious to make his or her title or even whether to use one at all. Some refuse to use the title at all, and others use "Sorcerer," "Warlock," or some other title. Most people don't bother Wizards about their titles; After all, it really isn't a good idea to have a spellcaster who can cast Formal Magic mad at you.

Common Formal magic Spells

Formal Magic Scrolls are magical scrolls of immense power in and of themselves and will always detect as magical. They are treated as Magic Items for purposes of stealing.

A Formal Magic scroll can only be read or copied by one who has the skill Formal Magic in the appropriate school. To everyone else,

the scroll will be unreadable.

Here is a description of some of the most common types of Formal Magic effects on Magic Items. This is not a complete list, but merely the ones which most players will encounter. *Please see the Formal Magic Casting Rules and individual Formal Magic Spell descriptions for more details.*

Bane

A magical defense that reflects the attack back upon the attacker. It works at will (even before a spell defense if desired), and protects against only one type of effect. For example, a Bane versus *SLEEP* could be used against a *SLEEP* spell or a *SLEEP* gas poison.

Cloak

A magical defense that works at will (even before a spell defense if desired) and protects against only one type of effect such as Fire or Binding Magic. For example, a Cloak versus Fire could be used against both a *FLAME BOLT* spell or an Elemental flame packet attack.

Obliteration

A very powerful Formal Magic that causes the victim to suffer the same effect as dying and resurrecting three times, although only one trip to the Earth circle is necessary. However, only one "pick" is made from death's bag. After the Formal Magic is complete, the victim is still able to receive a *LIFE* spell for the next five minutes, and only one such spell is necessary to restore the creature to one body point. If a *LIFE* spell is received, the creature is not forced to resurrect at all.

Spirit Link

Spirit Link magically attaches an item to a spirit, thus making it unstealable.

The item must always remain in contact with the creature to which it is linked. (It does not have to touch the body directly; a glove or other piece of clothing can come between the item and the person.) When a creature with a Spirit Linked item dies, the Spirit Linked item becomes insubstantial with the spirit and travels to resurrect, reforming with the spirit. If the item is a container, it does not bring the contents with it. If the creature permanently dies, the body and item return to the point where the body dissipated. The item is then linked to the next creature with a spirit that takes picks it up, even through gloves or other articles of clothing or armor.





Spirit Mark

Used to mark a particular person's spirit. The mark is always present on the spirit's body, in the location and with a design as decided by the original Formal Magic caster. This mark can be covered by normal means.

Vengeance

Causes a retributive strike of pure magical damage to any being inflicting a killing blow upon the bearer of this formal magic. This damage occurs after the killing blow and is not avoidable in any manner. When a Vengeance is triggered, the call will be "<number> Arcane Vengeance"

Formal Magic Components

In order to cast a spell from a Formal Magic scroll, one must also have the Formal Magic Components. These components are represented in-game by a tag with a description of the item and its level and type. Some chapters also provide the actual prop itself. If your chapter does not, it can only increase your role-playing fun if you were to provide your own props.

Formal Magic Components may be found as treasure in a module, on an NPC, or randomly in the woods.

Any character can tell if they are looking at a formal component automatically. To identify the level and type of components (i.e. P4 or C1) you must possess one level of the formal magic skill of either school.

Components come in various 'flavors':

Power (P), Creation (C), Elemental (E), Time (T), Void (V), Destruction (D), Spirit (S).

Each component has a value of 1, 2 or 4. Formal Magic costs are listed with the total value of each type of needed component. For example, P5 means any combination of Power components totaling a value of 5. One spell, *GREATER EXTENSION*, specifically requires a Power component of value 2 or 4 in addition to other components. Components expire no longer than 2 years after the issue date. If there is no printed expiration date then the expiration date is assumed to be one year.

Extended Circles of Power

In order to use the powers of an Extended Circle, you must be *Invested* in that Circle. Investiture is a Formal Magic Spell that must be cast upon you in that Circle.

In order to pass into or out of the Circle, you must be "*recognized*" by an invested member of the Circle. The invested member must clearly gesture, touch, or name the subject creature and must state "*the Circle recognizes you.*" This is an out-of-game statement, so it can be made while *Silenced*. The effect is understood in-game by all who hear it.

Upon being recognized, a person must *immediately* enter or exit the Circle. If the recognized person does not immediately act upon the recognition, then the recognition will expire.

Invested members may walk freely into or out of the Circle, since it is assumed that they "*recognize*" themselves. Invested members who are unconscious (or conscious, yet unwilling) will not pass through the Circle unless recognized by someone else. When using combat skills or spells, you must be completely inside or outside of the Circle of Power. For example, you cannot begin a spell incant inside the Circle, and then step out to throw your packet.



If you want to raid a Circle of Power, the same rules as raiding a cabin will apply; you must have a marshal present. See "Searching a Cabin" on page 95

Identify

An Extended Celestial Circle is capable of performing an Identify on an item or person. The item or person to be Identified and the invested person performing the Identify must be within the circle completely. The invested person touches the target of the identify and says "Identify".

If the target is an object directly then the invested person reads the tag describing the item's properties and learns them in the time it takes to read the information.

If the target is a person then the target tells the invested person which active spells or Formal Magic spells are active on them as well as what magical items they have in their possession and what the properties of those items are and how to activate them as though the items had been directly identified by the invested person. Sometimes an Identify will reveal additional properties of magical creatures. It takes as long to perform an identification of a person as it does for the target to describe all of the results.

Everyone who hears or observes the Identify call/process is aware of an identification taking place though they should attempt not to overhear the results. If you are Out of Game able to tell who the person performing the identification is, then you know who it is in game as well. If a transform is active and Identified, the school of it and the name of it are revealed, but neither the presence nor any information about a dormant transformation is revealed. You can prevent an Identification unless you're helpless.

The time to Identify is In Game. If you're interrupted then you are interrupted (including if contact is broken by the subject).

While there is no set order to presenting the information and you decide where to start, you must give out all the information you have with the chance of 3rd party interruption

Resurrection

An Extended Earth Circle is capable of providing Resurrections. The spirit to be Resurrected must be in the Circle. This will take 5 minutes to complete and will bring a body to full body points. During the 5 minutes, it is apparent to all observers that a resurrection is occurring, although the exact identity is unrecognizable to all except the invested healer performing the resurrection. The

healer may choose to reveal the identity of the person they are resurrecting, if desired. For more on resurrections, see "Matters of Life and Death" on page 22.

Magic Items

Magic items can be found or made through the NERO Formal Magic System©. Most give the wearer the ability to utilize a spell and some items grant the wearer effects from the Formal Magic system.

Until you have an item Identified, you will not have the tag for the item and thus will not be able to use it, even if you are already aware of the item's power. You must proceed to the Mages' Guild or monster camp to receive the tag. If you are given the item and are told in-game what the item's powers are and how it is used, you may use the item but must go to the Mages Guild or monster camp immediately thereafter to get the tag. Make sure that any player that gives you a Magic Item phys-rep also gives you the Magic Item Tag.

Activating Magic Items

Spells from a magic item act just like a regular spell. They provide the character, no matter what class or level, the ability to use that



spell. The correct process to activate an item is to use the phrase "Activate" followed by the spell incant. For Example:

"Activate With Mystic Force I Bind You".

In addition, all the normal rules for casting apply. You must have your hand free, have a packet, be conscious, etc. So you cannot activate an item when in a Web, unconscious, dead, or when tied up. Activating an item **IS NOT** a Game Ability, so you **CAN** use an item when you cannot otherwise use a Game Ability or Skill, such as when under the effects of a Taint Blood spell.

Magic Item Slots

Chapters may specify how many magic items a player may have active at any given time. This number is between one and five and is

clearly posted at event check-in or on the chapter's website.

If a character has more items on them than the allowed limit they must have a clearly delineated method to separate the active and inactive magic items tags. In order to switch between an active and inactive item at least one minute must be spent while you physically switch your tags between active and inactive. You may only make one switch at a time. If you lose possession of a magic item tag that item becomes inactive for you. During this time you may use no game skills. Characters must be conscious with at least one hand free to switch items between active and inactive states.

The following Formal Magic Spells will not cease to work on a magic item when it goes from active to inactive: *RENDER INDESTRUCTIBLE*, *EXTEND FORMAL MAGIC*, *GREATER EXTENSION*, *SPIRIT LINK*, *SPIRIT LOCK*, and *DELIMIT*.

Any item can still be used while inactive, but only with the benefit of the effects listed above.

This limitation on active magic items applies to both Unrestricted and Local Chapter Only Items only as a total (ex: 2 LCO and 3 Unrestricted "active" items in a 5 item slot campaign.)

Spirit as Magic Item

For only the purposes of Magic Item Slots, a character's Spirit counts as a single magic item that can be made active as a whole. Only the following formal magic spells count for the purposes of this "item:" *ENCHANT*, *CLOAK (MINOR)*, *BANE (MINOR)*, *SPELL STORE*, *PROTECTION AURA*, *CLOAK*, *BANE*, *EXPANDED ENCHANTMENT*, *SPIRIT LINK*, *SPIRIT LOCK*.

All other Spirit targeting formal magic spells fall outside of the Magic Item Slot rules. Please note that *SPIRIT LINK* and *SPIRIT LOCK* do not cease to work on an item that has been made inactive.

A PC is always aware of all formal magic spells on their spirit, including, school, specific type, and duration as applicable.

Definition of Basic Terms.

Formal Marshal: Some chapters require a separate certification

process for becoming a Formal Magic Marshal.

Caster: This term always refers to the Formal Magic Caster. This person is also known as the Primary Caster.

Secondary Caster: This term refers to those Formal Magic Casters (other than the Primary Caster) who are participating in a batch.

Levels: This always refers to the number of levels of Formal Magic possessed in the appropriate school. For instance, if a character is casting a *CELESTIAL FORMAL MAGIC*, then only count the number of levels of *CELESTIAL FORMAL MAGIC* he has purchased.

Dark Territory: This term refers to a formal magic that might not succeed. The outcome is determined by the marshal using random means, usually the role of one ten sided die (1=success, 2-5=flaw, 6-9=fail, 10=backlash). The chosen means of random determination must be explained to the caster, and performed in the presence of the caster. "Pick a number" is never acceptable. The marshal must record the chosen means (and the exact result) in the Formal Magic Log. The chances of success are seen on the chart below:

Table 4-1.

Formal Success		
ROLL	OUTCOME	%
1	Success	10%
2-5	Flaw	40%
6-9	Failure	40%
10	Backlash	10%

Batch: A group of formal magic castings of the same school of magic are lumped together into a single "Batch" so long as there is a gap no longer than a 60 seconds between each casting attempted. If more than 60 seconds elapses between formal magic castings within a batch, then the batch of formal magic locks into the just completed state and is no longer considered a batch. The formal magic Glyph of Protection can only be the first formal magic in a batch.



If the caster has cast other formal magic within the same batch, all formal magic attempted by that caster within that batch will count in the same game day – the game day in which the batch is begun.

Unrestricted: This term refers to an item that was placed into game according to the Treasure Distribution Policy issued by NERO. Magic items are also given this classification if they are constructed using components, scrolls, and production items of Unrestricted classification.

Local Chapter Only (LCO) : This is a special Plot related item or effect that can only be used in the issuing chapter. To all other chapters, the item does not exist for use in-game.

Pyramid: This term is used to describe formal magic castings that accumulate power based upon multiple casting within a batch. The scrolls *DAMAGE AURA*, *PROTECTION AURA*, and *SPELL STORE* are examples of this type of formal magic. The first step requires only a single casting, the next step requires two additional castings (for a total of three castings). To go further, three additional castings are needed (for a total of six castings), with the last step involving four additional castings (total of ten castings). These types of formal magic can never go past ten castings (four steps), and some may be limited below that number. Each step counts as one effect with regard to the 5 formal magic effect limit.



Special Types of Formal magic

Scroll Specific

A formal magic designated as scroll specific means that the scroll is limited to a single specific type of that formal magic, it is never all the possible choices on a single scroll. For example, the formal magic Cloak is scroll specific - the scroll will list the specific type of Cloak that it can be used to create, it may not be used to cast any type of Cloak.

Transform

All Transform formal magic is considered dormant. The existence of a Transform is not revealed during a Celestial Identify. At the time of the target's permanent death, the target becomes an NPC at the chapter where the transform was cast. Even after permanent death, certain Transforms can upgrade or weaken the creature as per this handbook. See the individual formal magic scrolls for details. After the permanent death of the target, the formal magic takes effect to permanently transform the target into the specified creature. This may take place immediately, or may take several weeks. The details are left to local NERO Plot. Once transformed into the creature, the Transform formal magic is complete. The newly transformed

creature will have the currently-active spirit-affecting formal magics as they did before the transformation, except for the Transform itself.

Effects exist which may for limited duration invoke the full transformation prior to permanent death. Circumstances which may temporarily invoke the transformation prior to permanent death are determined exclusively by the Plot/Staff of the local NERO chapter. In situations where the transformation takes place prior to the permanent death, the Transform is no longer dormant, and can be Identified in an appropriate Extended Circle of Power. The invocation of the transformation is generally not for use during situations where PCs are directly pitted against other PCs. The final determination of this is up to the local chapter.

Only one Transform may be in effect on any spirit at any one time. A new Transform formal magic will replace an old one on a target spirit. This includes Local Chapter Only Transform formal magic.

Being an NPC means that the target is completely under the local chapter's direction. There is certainly no guarantee that the local chapter will even let the NPC ever come into game. If local plot chooses to allow the NPC to come into game, there is also no guarantee that the local chapter will allow the character to pursue the goals from its normal lifetime.

Creation and Summoning

Local Plot must be notified well before the casting of this type of formal magic.

When the creature appears, a new card will be supplied, regardless of the statistics of the creature when it originally appeared.

The caster may be required to supply an NPC to play the part of the creature or the local chapter may supply the NPC. This policy varies from chapter to chapter, please check in advance with the local chapter. The local chapter can always substitute a staff

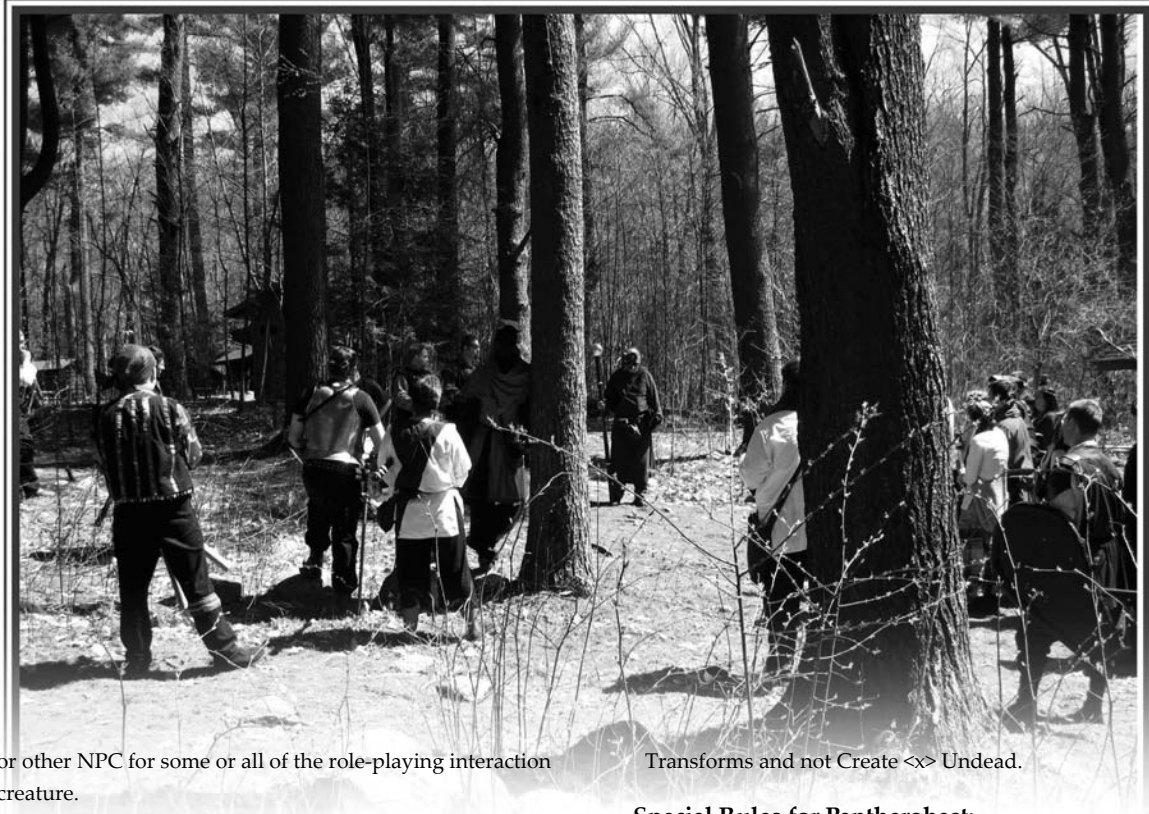

member or other NPC for some or all of the role-playing interaction with the creature.

When this formal magic is performed, the marshal should consult the local guidelines for information on the attitudes and personality of the creature. The NPC playing the creature must abide by the personality requirements and directives given to them by the formal magic marshal. Failure to do so may result in the termination of the role and loss of the creature.

Unintelligent creatures will only follow simple 25 word (or fewer) command phrases with a single condition and a single objective. For example, an acceptable command would be *“Follow me and kill anyone who attacks me”*, *“Attack anyone who enters this room besides these six people”*, *“Attack anyone who enters the crypt and isn’t wearing this symbol”*, or *“Follow me and search every creature I kill”*. Control of unintelligent creatures can never be passed to someone else. All commands are subject to approval of the local chapter.

Intelligent creatures are not automatically controlled. They may be friendly or may simply attack. Negotiations may take place between the caster and the created or summoned intelligent creature.

A creature created or summoned in one NERO chapter might be prohibited from being taken to another chapter. If the creature can be taken to another chapter, the card used will be the card of the similar creature at the destination chapter.

Approved Types of Summonings may be added to at local staff discretion, but other chapters may not accepted these additional types.

Special Note for Creating Undead:

The Create <x> Undead Formal Magic spells cannot create Greater, High, or Master level undead. Undead of Greater, High, or Master level of power that are created via Formal Magic are the result of

Transforms and not Create <x> Undead.

Special Rules for Pantherghast:

A Pantherghast will be genocidal against one race. The Pantherghast will focus on the race named by the caster. The Pantherghast may choose to role-play with the caster before beginning the hunt. Pantherghasts seek to exterminate the hunted race.

Figure 4-1.

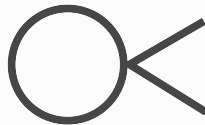

Golems

The creation of Golems follows the Creation and Summoning rules above in addition to the rules below.

The formal magic will create a golem, and place a willing spirit and associated body designated by the caster into the golem. If the caster places a simple animal within the golem, then the animal need not be willing at all, and the golem is mindless and under the control of the caster. If an intelligent spirit and body are placed within a golem, then that spirit will be able to command the golem from inside, and use all of the golem’s full abilities. The golem will always be recognizable as the spirit who inhabits the golem. Note that any attempt to extend the golem through other formal magic casting will fail, consuming the components. The golem will cease functioning 5 days after the first command it executes, regardless of whether or not it has been extended.

In addition to the components, this formal magic requires silver pieces equal to the number of body points divided by ten (round up) which will be incorporated into the body of the golem, and is retrievable when the golem is destroyed. On occasion, some (or all) of the silver will be useless and irretrievable.

A golem will always be unaffected by Life and Death effects, and will be considered “Dead” as soon as it reaches zero body points or receives a killing blow, even if it can normally be healed. If this occurs, any spirit and body that inhabit a Golem will seek resurrection.

When this formal magic expires, the spirit and body will emerge without the occurrence of a death. The body will retain any battle magics that were cast upon the golem, and exhibit wounds identical to the golem's (i.e., if the golem had a shield magic spell and was down by 15 points, the person takes the shield magic spell and is down by 15 body). The person will have at least one body point.

If Destroy Celestial Magic is successfully cast on the golem, the spirit and body will emerge without the occurrence of a death in a similar condition as described above.



Casting Rules

Anyone who possesses the skill Celestial Formal Magic or Earth Formal Magic may cast from formal magic scrolls of the appropriate school.

Formal Magic Scrolls are Indestructible unless Flawed otherwise.

The caster(s), Formal Magic Components, Formal Magic Scroll(s), and the target of the formal magic must be within a specially scribed representation on the ground. This representation must be drawn in the shape of a circle with a V. (Figure 4-1). This is known as a "fishtail," and is not protective in any way. The representation must also contain sigils, runes, or other symbols, fetishes, implements or props to indicate that a powerful magic is going to be cast. This representation is often also termed a "Circle."

No Formal Magic may have a duration of longer than two years, with the exception of transmutations.

Casting Time

The standard time to cast any formal magic is five minutes.

However, if a formal magic is directly harmful to a PC the casting time is one hour, though the PC may opt to allow the normal five minute casting time if they inform the marshal at beginning of the formal. This option does not apply to the Obliterate formal magic or formal magic that does not target the PC's personal items or spirit. The decision to choose this option is wholly out of game and is not subject to any in game coercion, review, or planning.

The hour casting time is automatic upon the desire of anyone in the Circle or the Marshal. 'Harmful' includes destroying a ward or circle, placing a formal magic circle around a ward, using a formal magic to escape PC pursuit, etc.) If the formal magic is directly harmful to an NPC the casting time is determined by the appropriate representatives of the chapter and may vary between five minutes and one hour.

Game Day

The game day is defined as 6:00 PM to 5:59 PM the following day. Some chapters end the game day at around 3 PM.

Durations measured in game-days are considered to include the current game-day or portion thereof – thus an effect with a duration of one game-day will expire at the beginning of the next game-day, even if that is only one hour away.

Item and Character Transferability

If any LCO components, scrolls, items, or spells are used to create magic item, the resulting item becomes LCO. LCO stands for Local Chapter Only, the item cannot be taken to another NERO Chapter.

This includes new spells that are being tested.

Since the spirit of a player character is by default an item of unrestricted transfer all formal magic upon the spirit of a player character is listed on that character's card. A Local Chapter Only Formal Magic on the spirit is considered in the total limit on formal magic upon a single spirit. The effect of Local Chapter Only formal magic on the spirit will be suppressed when outside the chapter of origin.

A PC is always aware of all formal magic effects on his or her spirit, including school, specific type, and duration as applicable.

A formal magic caster can not cast more than one formal magic spell at any given time.

Target Effect Limits

No target may retain more than 5 different formal magic effects simultaneously. If a target already contains 5 formal magics, and a sixth casting is attempted, the casting will fail on that target. A single spirit or item can only retain 5 formal magic effects. Any formal spell with the duration of instantaneous is not retained, thus Obliterate, Spirit Forge, etc. do not count toward this 5 effect limit. In addition, the following lasting effects are exceptions to this rule and do not count toward the five effect limit on a spirit or item:

Extend Enchantment, Extend Formal Magic, Greater Extension, Investiture, Render Indestructible, Interplanar Travel, Planar Asylum, Spirit Walk, Whispering Wind, Dreamvision, Create High Horoscope, Transform to Greater Creature, Transform to High Creature, Transform to Master Creature, and Create <x> Golem.

The spirit mark/unmark Cantrips will count against the five effect limits.

Fishtail Requirements

All formal magic castings must be performed within an appropriate fishtail representation. If two or more formal magic castings are performed in the same fishtail representation at the same time they are all cast in Dark Territory.

Success versus Failure

The caster may cast a total number of levels of formal magic they possess in the appropriate school with automatic success in any one game day. A caster may cast an additional number of formal magic levels equal to the total levels of formal magic they possess in the appropriate school of magic in Dark Territory. A caster cannot cast beyond Dark Territory. A caster cannot even attempt to cast from a scroll that is higher level than the number of levels of Formal Magic skill he possesses in the appropriate school.

Multiple Formal magic Spells Cast upon a Single Target

The total level of formal magic cast upon a target in a single batch may be no greater than two times the total levels of the appropriate school of formal magic possessed by the Casters participating in the batch.

From this upper limit subtract the total levels of formal magic each of the casters has cast prior to the start of this batch the same game day.

The caster of any individual formal magic within a batch must be designated just prior to the start of that formal magic and that caster must be in possession of the scroll at the start of the formal magic for which he is caster.

All casters involved in a batch must be within the fishtail for all formal magic cast within that batch. If any caster drops out between formal magic castings in a batch, the total level of formal magic allowed within the batch is recalculated. That caster is no longer required to remain in the fishtail. If the total levels of formal magic already equals or exceeds the new limit then the batch terminates. No formal casters may be added to a batch once the batch begins.



Tags

Every formal magic in this system has a corresponding tag. Chapters are not permitted to re-issue tags issued from another chapter without National approval. Thus players may not add formal magic effects to items tagged by other chapters, since the local chapter may not re-issue the tag. Chapters may re-issue tags from their own chapter (adding new effects if appropriate), but the Transferability status of an item can never increase. This means that if an Unrestricted transfer item has an LCO Enchant cast it, the tag must be reissued as LCO. If an item has effects of varying durations, the duration of each effect must be marked. Magic item tags cannot be otherwise marked or modified other than to reduce numbers of charges or destroy the tag.

Each tag for items generated using the Formal Magic system must be marked as "Indestructible" or "Destructible"

Targets

The target of a formal magic must be declared at the beginning of a formal magic and may not be changed during the casting. If the target has a spirit the target will know immediately that it is the target of the formal magic and what formal magic is being cast. In the case of multiple targets, all such targets must be declared.

Formal magic spells that target a spirit may be refused, with the exception of Investiture/Divestiture, Create Mark / Destroy Mark and Obliterate. The Formal Marshal will inform the target that he is able to refuse this formal magic and the consequences thereof. This can be done anytime up to the end of the formal magic casting, prior to any die roll (if needed).

Refusing a formal magic cast upon a spirit will cause the target to die and immediately leave to seek resurrection. This holds whether or not the target is conscious.

Pyramids

Casting a pyramid based formal magic upon an item with the same pyramid based formal magic already on it (from another batch) does not increase the original pyramid. In order to increase the size of a pyramid once cast, a new pyramid larger than the first must be cast, in which case the first pyramid immediately expires and the second pyramid takes effect.

Effects of Gypsy Curse upon Formal Magic

Gypsy curse may in no way affect the casting of the formal magic.

Flaw and Backlash Effects

Flaws and Backlashes are identifiable in an extended celestial circle and in most cases lingering effects are removable by a Destroy Magic formal magic.

Pre-Event Formal Magic Use

At the individual chapter's discretion any character with the appropriate skills can cast

formal magic spells at check-in as part of logistics if he wishes. In order to do so, the character turns in the required components to the production station at check-in and all scrolls that are to be used. The caster will not need to role-play the casting of the formal magic spells that are cast in this way, and he can only cast spells using auto-success. No spells may be cast in Dark Territory at logistics in this way. Special plot-related formal magic castings must always be cast in-game and cannot be cast using this method. At the end of logistics, the formal magic caster will have the appropriate number of levels removed from his first day's ability, and all scrolls that were not used up will be returned with the appropriate modifications to them. If for any reason the production staff person cannot complete the caster's formal magic logistics, all scrolls and components will be returned to the formal caster and he will be forced to cast the desired spells in-game using the standard rules for formal magic casting. Spells that target an unwilling spirit, an item that automatically resists such as a circle of power or ward, or that are "in-game" unlawful within the local region cannot be cast in this way.



Casting Walkthrough

When a scroll specifies that an action must be taken during the "time of formal casting" (e.g., Enchant), then it may be done at any time during the casting of the formal magic.

Materials Checklist

Here is a complete list of what is needed to begin a Formal Magic:

- ☛ The Scroll. The caster is responsible for reading and understanding the scroll.
- ☛ Formal Magic Components for each Formal magic Spell.
- ☛ A fishtail representation in which to cast.
- ☛ The Caster.
- ☛ The Secondary Casters (if any).
- ☛ The target(s) of the formal magic.
- ☛ The Marshal, who will need:
- ☛ A white headband.
- ☛ These rules, including the individual scroll descriptions.
- ☛ Component Identification charts.
- ☛ Formal Magic Log/Receipt Book.
- ☛ Flaw & Backlash charts
- ☛ A ten sided die.

Finding a Marshal

The caster is responsible for locating the marshal. Some chapters provide a list of the available marshals at a given event to players

who inquire. It is best to arrange a time in advance with a marshal. Many Marshals are players too, and there is no guarantee that a request for a marshal can be granted if it is 3:00 AM, especially if arrangements haven't been made in advance. The marshal must remain out of game for the entire duration of all formal magic castings. The marshal's character cannot be present in any way, even as a mere onlooker. Many chapters do not allow a marshal to marshal a formal magic in a situation where his or her close friends are involved, especially for fellow in-game associates.

Marshal/Caster Preparation

- A. Prior to the actual start of the formal magic any players involved should be informed by the marshal if the resulting item will be of any other category besides Unrestricted and why. This requires an advanced examination of all materials involved in all of the formal magic castings. Since magic item categories are mostly due to out of game issues, the intent of this rule is to insure customer satisfaction. In order to have Unrestricted transferability all components, scrolls, and effects used must be Unrestricted. No effect that alters these rules may be in effect. If these conditions are not met the item or effect created will automatically be Local Chapter Only.
- B. Identify the components to make sure they are correctly marked, if necessary. Insufficient components will result in the marshal stating "The Formal Magic does not begin". If this occurs, the components are not consumed. If the spell is part of a declared batch, the marshal will notify the player that the components are insufficient before the batch begins. (Inform the player later, during step D)
- C. Read the Formal Magic Scroll. Make sure that there is a complete understanding of the scroll, and follow any special instructions on the scroll. If the scroll is Unlimited and only usable once each



day, verify on the back of the scroll (or the back of the tag) that the scroll hasn't been used today. If the physical representation of the scroll varies from the current version, then the current version must be used. The only flaw allowed upon a formal magic scroll is "Flaw: this scroll cannot be copied" or "Flaw: this scroll is destructible".

During the Casting of the Formal Magic

- D. In order to begin the formal magic, the Caster states "Beginning Formal Magic". Confidentially ask the Caster if they are waiving auto-success, and casting in Dark Territory. Insufficient components will result in the marshal stating "The Formal Magic does not begin". If this occurs, the components are not consumed.
- E. The caster must declare the target(s) of the formal magic. The target, if a spirit, must be made aware of this by the marshal.
- F. The Caster(s) must indicate to any casual, secret, or imagined observers that they are performing a formal magic. This must be accomplished through various role-play methods, like constant movement or verbal action or a combination of both. The exact amount of role-play or activity is left up to local plot/rules. The movement can be as simple as constant, circular hand motion or as complicated as broad movements or the hands and/or arms, dancing movements of the entire body, or stylized movements such as drawing of symbols or lighting candles or incense. Verbal action would include litany speech, question and reply, chanting, or recitation in a "magical language". The caster may not engage in regular conversation. Any method chosen by the caster must make use of the components and the scroll. Poor performance on the role-playing aspect of the formal magic casting will cause the marshal to issue a warning. After receiving two such warnings,

the third occurrence of poor performance will result in automatic failure of the formal magic.

- G. The formal magic automatically backlashes under the following conditions:
 - Ⓜ Any caster is struck or becomes unconscious.
 - Ⓜ Any caster is struck with a ranged attack, Disrupted, takes body damage or becomes unconscious
 - Ⓜ If any caster cannot speak, move their hands, or easily be in a position from which they could see the formal magic scroll even if they are not currently looking at it.
 - Ⓜ If any caster uses any other game skill other than those required by the formal magic scroll or Read/Write, Wear Extra Armor, or Dexterity Armor.
 - Ⓜ If any caster ceases casting the formal magic, voluntarily or involuntarily.
 - Ⓜ The formal magic components, formal magic scroll, or any target is damaged (Shattered, Destroyed, Explosive Trap, numerical damage), destroyed, dies, becomes unusable, or leaves the fishtail circle. Anything that leaves the circle is always affected by the backlash as if it were still inside the circle.
- h. If the formal magic casting is completed, allow the Caster to roll the die if required to do so and allow all casters to see the results. Each caster knows the results of the formal magic. Record the results in the Formal Magic Logbook. If the caster(s) wish to perform more formal magics, then the Marshal should not write any tags until it is convenient. All components should be collected at this time. All times-ever Scrolls should be collected at this time. All used components and scrolls must be turned in by the Marshal in an unusable state, along with the Formal Magic Logbook, however do not render them unusable if a Flaw has resulted until after the results of the flaw are fully determined and implemented (see below). Perform the following additional instructions:
 - Ⓜ **Success:** The formal magic completed properly, follow the instructions on the Scroll. The components are consumed.
 - Ⓜ **Flaw:** The formal magic completed, but with skewed results. Refer to the flaw table in the Formal Magic Packet to determine the results. If one of the results indicates that any of the components or the scroll is not consumed, then return the appropriate items and indicate the flaw caused these items to not be consumed in the formal magic log. If the result indicates that the target should receive an additional formal magic effect and the target is at the limit of effects it can hold, the additional effect will fail.
 - Ⓜ **Failure:** The formal magic was a complete failure, resulting in no magical effects.
 - Ⓜ **Backlash:** The formal magic was a complete failure, and generated a very powerful magical side effect. Refer to the "Backlash Table" in the Formal Magic Packet and determine the results and apply them as directed.

After Casting the Formal Magic

- I. Make out any receipt that is applicable at this time, delay the receipt if the item is still within a batch. All components should be rendered useless at this time. Also, any Limited (times ever) formal magic scrolls should be marked accordingly or rendered useless at this time. Unlimited formal magic scrolls should have each use that results in Success or Flaw recorded on the back of the scroll, or with the scroll in some manner. Indicate the casting of this formal magic on the caster's card, including the date, time completed, level and results. Indicate results in the log and indicate any results that need be entered on any character's card

Cantrips Overview

For a player to cast a Cantrip they must have the skill Earth Formal Magic or Celestial Formal Magic. A player may cast one Cantrip of their school of magic per day for each level of formal magic they possess.

The full list of Cantrips, their effects, and components costs is available at www.nerolarp.com.

Cantrip Tome

In order to cast a Cantrip the player must be carrying a Cantrip



at logistics or that must be referred to another chapter.

In accordance with the instructions on the Scroll, prepare a temporary tag and receipt for the players and a receipts for logistics, to represent the successfully cast formal magics properly. Take all expended components, expended Scrolls, and all other materials expended in the casting of the formal magics, and turn them in with the logistics half of the receipt. (It is best to use a sealed plastic bag). Inform the player(s) that a final tag will be delivered to them as soon as possible, but they must retain the receipt and trade it in for a permanent, laminated tag. All Magic Item and Magic Effect Tags in NERO are to be kept in a permanent database. All tags must be printed from that database and signed by an authorized member of staff. Any Magic Item/Effect Tag found which is not in the database is subject to confiscation pending a disciplinary investigation.

All expended components, scrolls and other tags should be turned in to Logistics so they may be returned to the chapter of origin for tracking purposes.

tome which contains the Cantrip they wish to cast. Cantrip tomes are in game objects that must be acquired in game. The phys-rep for a Cantrip tome must be at least 6" x 4". The tome is governed by the rules defined in the Enchant Cantrip Tome Cantrip.

Cantrip Pages

In addition to Cantrip tomes, there are also Cantrip pages. Cantrip pages function like Cantrip tomes but are of one use only and will only contain a single Cantrip. A Cantrip page must follow the rules for size as if it were a scroll and must be read and a packet touched to it in order to cast from it.

Casting

To cast a Cantrip the player must incant the proper incant for the Cantrip and physically break or tear the number of level one components designated for that particular Cantrip (0, 1, or 2) to gain the power for the Cantrip. When casting a Cantrip with 0 component cost there need not be a "tearing" motion.

Breaking or tearing a single level two component will power a Cantrip which takes 2 components or two Cantrips which take

1 component cast one immediately after another. Breaking or tearing a level four component will power two Cantrips which take 2 components or four Cantrips which take 1 component cast one immediately after the other.

The components must be broken or torn within 10 seconds of finishing the incant. The components used for a Cantrip may only be unrestricted NERO components or local to the chapter in which the Cantrip is being cast. The components must be identifiable by the chapter which they are used in at the time of the casting, and they may not be SR components. Components are to be turned into a marshal after the casting of any Cantrip. The components will be checked at this time.

Cantrips are cast on the fly for any Cantrip in the carried tome(s). Cantrips do not require a fishtail to cast. Cantrips are never thrown at an opponent in the manner of battle magic, but they may allow the caster to throw a packet or series of packets with a defined effect (e.g. 10 elemental fire). Casting a Cantrip is subject to Spell Disruption. No other skill or item may be used from the point when the incant is started till the point when the components are snapped or torn or the Cantrip will fail and the components are still consumed.

A Cantrip may never be extended in any manner or placed into an item in the manner of an enchantment, expanded enchantment, etc. A Cantrip or the effect of a Cantrip may never be spellstored.

The statement "dies and requires a life spell" refers to any time the character is dead whether they receive a life spell or not, resurrect, regenerate, revives through a manner other than a life spell, or is not affected by life.

There are five types of Cantrip:

1. **Personal:** These Cantrips cause an effect upon the caster of the Cantrip. They may not be placed on another nor may they be transferred. For the effect of a personal Cantrip to remain the PC must retain the skill Formal Magic <school>. If they lose the skill in any manner the Cantrip will cease functioning. If they still possess the skill but may not use e.g. are tainted or drained they do not lose any Cantrips upon them. In addition they must retain the Cantrip Tome with the Cantrip they placed upon themselves. Losing possession of the Tome even to allow another to cast a Cantrip from the tome will negate any current personal Cantrips.
2. **Item:** These Cantrips are cast on an item with no spirit only.
3. **Spirit:** These Cantrips are cast on a recipient with a spirit only. They may not be thrown but must be touch cast in a NERO legal manner by being touched with a packet. If the target is not willing, the Cantrip fails.
4. **Broad:** These Cantrips affect a broad category in the estate/military system of NERO and are usually never used in play during an event. On occasion plot may define specific uses of these

Cantrips during actual play such as weakening a building under siege with Weaken Defense but they may NEVER directly affect PCs or NPCs in play.

5. **Offensive:** These Cantrips give the caster the ability to directly attack opponents and thus their effect would be stopped by the appropriate normal spell defenses.

Cantrips may have the following durations:

- Ⓜ **Hour:** One Hour
- Ⓜ **Day:** One Day, until the next Standard Reset or game end, whichever occurs first.
- Ⓜ **Instant:** Immediate and not lasting, the effect on another may last.
- Ⓜ **Year:** Until removed by in game methods or 1 year passes.
- Ⓜ **Concentration:** The caster must maintain concentration to keep this Cantrip going
- Ⓜ **Invoked:** When an invoked Cantrip is cast the caster will receive 5 charges of the effect in the appropriate school of formal magic. Using the effect uses one charge. An effect can be used against a single opponent for a maximum of 5 minutes or line of sight. All unused charges expire at the next tag reset. Multiple charges may be used against multiple opponents at the same time. The caster must state "I Invoke <Cantrip name> against you" to the opponent it is being used against such that the opponent can hear it. This is an in game statement and the caster may not do it if silenced.
- Ⓜ **2 Year:** Until removed by in game methods or 2 years passes.

Unless otherwise indicated, the effect of any Cantrip with the duration of Day is lost if the target requires a life spell.



spells



Spells



Every Spell listed here is available at every NERO Chapter.

The information after the spell's in game name includes the spell's level, whether it is Celestial or Earth, whether it can be made into a Potion or Scroll, whether it can be Manifolded, and its duration.

Spell Defenses

There are a few spells and effects that will defend the recipient from incoming spells or attacks. Each can protect against one spell or effect only. They are cast upon the recipient in advance and stay with the recipient until "activated" by the effect they are meant to prevent. The Spell Defenses are *DISPLACEMENT, ELEMENTAL SHIELD, GUARDIAN OF THE FOUR, MAGIC ARMOR, POISON SHIELD, REFLECT MAGIC, and SHIELD MAGIC.*

In-game, you are always aware of what Spell Defenses are active on you. Once a Spell Defense is active, then it will affect the next applicable incoming effect, regardless of whether or not you would have been affected. It will then be used up.

All Spell Defenses must be called correctly, for example "Reflect Magic" or "Phase," to be effective and must be called within three seconds or are lost or not used respectively.

Spell Durations

Concentration

This spell lasts as long as the caster maintains concentration. While concentrating, the caster cannot run or use any game skills.

Continuous

Continuous is a specific form of concentration which requires the caster to continually chant a litany, recite a verse, or sing a song with the limits listed under *MANIFOLD page 39* except you do not need the *MANIFOLD* skill or a *Hearth*. At the end of each repetition the caster may state the incant for the spell and deliver the effect as specified in the description of the spell. As long as the caster continues to repeat the verse they may continue to recast the spell using only one spell slot. Each spell with this duration may impose other limits upon the caster to continue the spell. The caster may not speak outside the words of the verse or incant and may not use other skills while continuing a spell and may not pause longer than 5 seconds. The limitations of Concentration also apply. If a continuous spell is used once the caster may simply state the incant.

Timed

Some spells last for a specific amount of time, either 5 seconds, 1, 5, or 10 minutes, 1 hour, or 5 days.

Instant

The duration of this spell is instantaneous, but its effects may be permanent. (Thus, any damage taken from these spells is permanent until cured.)

Indefinite

The effects of this spell are permanent unless the victim receives the proper counter spell or the spell's effect is used up (or the victim dies). The counter spell will be listed in the spell description.

Line of Sight

This spell lasts as long as the caster could see the victim from wherever the caster is located. It also lasts if the victim could see the caster.

Basically, if you can draw a straight line between the caster and the victim without the line being obscured by any large, immovable obstacles, then the Line of Sight is still in effect. The caster closing their eyes or hiding behind someone else does not break Line of Sight.

If the caster breaks Line of Sight by imposing a very large object such as a building or large tree between the caster and the victim for longer than 10 seconds, the spell is broken. If view of the character is resumed before the 10 seconds is up, then the spell continues. These spells will cease immediately if the caster falls unconscious line of sight lasts for a maximum of 5 days.

Celestial:		Earth:	
Scroll:		Potion:	
Manifold:		<i>Figure 5-1.</i>	



Table 5-1.

SPELL							DURATION
4	Awaken	✓	✓	✓	✓	✓	Instant
9	Banish	✓	✓				Instant
4	Bind	✓	✓	✓			Line of Sight
1	Bless		✓		✓		Indefinite
4	Calm	✓	✓				5 Minutes
1	Calm Animal		✓				5 Minutes
6	Cause Critical Wounds		✓		✓	✓	Instant
3	Cause Disease		✓		✓	✓	Indefinite
1	Cause Light Wounds		✓		✓	✓	Instant
8	Cause Mortal Wounds		✓		✓	✓	Instant
4	Cause Serious Wounds		✓		✓	✓	Instant
2	Cause Wounds		✓		✓	✓	Instant
7	Charm	✓	✓				5 Minutes
3	Charm Animal		✓				5 Minutes
6	Circle of Harmony	✓	✓				1 Hour
9	Circle of Power	✓	✓				10 Minutes
8	Confine	✓	✓				Line of Sight
2	Control Undead		✓				5 Minutes
8	Corruption		✓				1 Minute
7	Create Undead		✓				5 Minutes
6	Cure Critical Wounds		✓		✓	✓	Instant
3	Cure Disease		✓		✓	✓	Instant
1	Cure Light Wounds		✓		✓	✓	Instant
8	Cure Mortal Wounds		✓		✓	✓	Instant
4	Cure Serious Wounds		✓		✓	✓	Instant
2	Cure Wounds		✓		✓	✓	Instant
7	Curse		✓		✓		Indefinite
9	Death		✓				Instant
2	Delayed Endow	✓		✓		✓	Indefinite
4	Desecrate		✓				Indefinite
6	Destroy	✓	✓	✓			Instant
7	Destroy Undead		✓				Instant

Table 5-2.

SPELL							DURATION
2	Detect Magic	✓	✓	✓			Instant
8	Dispel Magic	✓	✓	✓	✓	✓	Instant
8	Displacement	✓					Indefinite
8	Dragon's Breath	✓		✓			Instant
9	Eldritch Blast	✓					Instant
4	Elemental Blade	✓		✓		✓	Indefinite
6	Elemental Shield	✓	✓	✓	✓	✓	Indefinite
2	Empathic Healing		✓				Instant
6	Enchanted Blade	✓		✓		✓	Indefinite
1	Endow	✓		✓		✓	Indefinite
6	Enflame	✓					Instant/5 sec
7	Extended Hearth	✓	✓				Indefinite
4	Flame Bolt	✓		✓			Instant
1	Free Undead		✓				Instant
1	Fumble	✓	✓	✓			5 seconds
7	Guardian of the Four	✓		✓		✓	Indefinite
3	Harm Undead		✓				Instant
3	Help Undead		✓				Instant
3	Ice Bolt	✓		✓			Instant
7	Ice Storm	✓		✓			Instant
9	Imprison	✓					10 Minutes
1	Illumination	✓	✓				5 Days
1	Improved Hearth	✓	✓				1 Hour
9	Inspiration		✓				Instant
7	Lesser Divestiture	✓					Instant
7	Lesser Investiture	✓					5 Days
9	Life		✓				Instant
2	Lightning Bolt	✓		✓			Instant
6	Lightning Storm	✓					Instant
2	Magic Armor	✓	✓	✓	✓	✓	Indefinite
1	Magic Missile	✓		✓			Instant
9	Magic Storm	✓					Concentration
7	Mystic Lock	✓					5 Days
8	Paralyze		✓				5 Minutes
2	Pin	✓	✓	✓			Line of Sight

Table 5-3.

SPELL							DURATION
4	Poison Shield		✓			✓	Indefinite
5	Purify Blood		✓		✓	✓	Instant
3	Refit Armor	✓				✓	Instant
8	Reflect Magic	✓	✓	✓	✓	✓	Indefinite
8	Regeneration		✓				1 Minute
5	Release	✓	✓	✓	✓	✓	Instant
7	Remove Curse		✓		✓	✓	Instant
7	Remove Drain		✓		✓		Instant
4	Remove Fear	✓	✓				Continuous
6	Remove Physical Affliction		✓		✓	✓	Instant
3	Remove Weakness		✓		✓	✓	Instant
2	Repel	✓	✓	✓			Concentration
7	Restore Limbs		✓		✓	✓	Instant
4	Sanctuary		✓				Indefinite
3	Shatter	✓	✓	✓			Instant
1	Shield	✓		✓		✓	Indefinite
5	Shield Magic	✓	✓	✓	✓	✓	Indefinite
4	Shun	✓	✓	✓			5 Minutes
1	Shun Animal		✓				5 Minutes
5	Silence	✓	✓				5 Minutes
5	Silver Aura	✓		✓		✓	Indefinite
6	Sleep	✓	✓	✓	✓		5 Minutes
1	Stabalize		✓				Continuous
5	Stone Bolt	✓		✓			Instant
5	Taint Blood		✓		✓		Indefinite
7	Tarry		✓				5 Minutes
1	Trap Undead		✓				Line of Sight
2	Turn Undead		✓				5 Minutes
8	Unparalyze		✓		✓	✓	Instant
9	Ward	✓					5 days
3	Weakness		✓		✓		Indefinite
5	Web	✓	✓	✓			Line of Sight
7	Wither Limb		✓		✓		Indefinite

HEALING /CHAOS PROGRESSION	DAMAGE	Table 5-4.
Light Wounds	5	
Wounds	10	
Serious Wounds	20	
Critical Wounds	30	
Mortal Wounds	40	

BATTLE MAGIC PROGRESSION	DAMAGE	Table 5-5.
Magic Missile	5	
Lightning Bolt	10	
Ice Bolt	15	
Flame Bolt	20	
Stone Bolt	25	
Lightning Storm	30	
Ice Storm	35	
Dragon's Breath	40	
Elemental Blast	45	

CHARM EFFECTS	VALUE	Table 5-6.
Calm /Calm Animal	1	
Shun/ Shun Animal	2	
Charm/ Charm Animal	3	
Fear	4	
Control Undead	5	
Vampire Charm	6	
Enslavement	7	

* Charm effects are overridden by newly cast charm effects of equal or higher value.

BLADE EFFECTS	LEVEL	Table 5-7.
Endow	1	
Delayed Endow	2	
Elemental Blade	4	
Silver Aura	5	
Enchanted Blade	6	

CELESTIAL		EARTH	
<i>Table 5-8.</i>			
LEVEL 1	Endow	Bless	
	Fumble	Calm Animal	
	Illumination	Cure / Cause Light Wounds	
	Improved Hearth	Fumble	
	Magic Missile	Illumination	
	Shield	Improved Hearth	
		Shun Animal	
LEVEL 2		Stabalize	
		Trap/Free Undead	
	Delayed Endow	Cure / Cause Wounds	
	Detect Magic	Detect Magic	
	Lightning Bolt	Empathic Healing	
	Magic Armor	Magic Armor	
LEVEL 3	Pin	Pin	
	Repel	Repel	
		Turn / Control Undead	
	Ice Bolt	Cure / Cause Disease	
LEVEL 4	Refit Armor	Charm Animal	
	Shatter	Harm/Help Undead	
		Weakness / Remove Weakness	
		Shatter	
	Awaken	Awaken	
Bind	Bind		
Calm	Calm		
Elemental Blade	Cure / Cause Serious Wounds		
Flame Bolt	Elemental Blade		
Shun	Poison Shield		
	Remove Fear		
	Sanctuary / Desecrate		
	Shun		

CELESTIAL		EARTH	
<i>Table 5-9.</i>			
LEVEL 5	Release	Purify/Taint Blood	
	Shield Magic	Release	
	Silence	Shield Magic	
	Silver Aura	Silence	
	Stone Bolt	Web	
LEVEL 6	Web		
	Circle of Harmony	Cure / Cause Critical Wounds	
	Destroy	Circle of Harmony	
	Elemental Shield	Destroy	
	Enchanted Blade	Elemental Shield	
	Enflame	Remove Physical Affliction	
LEVEL 7	Lightning Storm	Sleep	
	Sleep		
	Charm	Charm	
	Extended Hearth	Destroy Undead / Create Undead	
	Guardian of the Four	Curse / Remove Curse	
LEVEL 8	Ice Storm	Extended Hearth	
	Lesser Investiture	Remove Drain	
	Lesser Divestiture	Wither Limb / Restore Limbs	
	Mystic Lock	Tarry	
	Confine	Cure / Cause Mortal Wounds	
	Dispel Magic	Confine	
LEVEL 9	Displacement	Regeneration / Corruption	
	Dragon's Breath	Dispel Magic	
	Reflect Magic	Paralyze / Unparalyze	
		Reflect Magic	
	Banish	Banish	
Circle of Power	Circle of Power		
Eldritch Blast	Death / Life		
Imprison	Inspiration		
Magic Storm			
Ward			

"I call upon the Earth to..."

Figure 5-2.

"...Cure Light Wounds 5"	1	Cure Light Wounds
"...Stabilize you"	1	Stabilize
"...Trap Undead"	1	Trap Undead
"...Cure Wounds 10"	2	Cure Wounds
"...Transfer <Effect>"	2	Empathic Healing
"...Cure Disease"	3	Cure Disease
"...Harm Undead"	3	Harm Undead
"...Cure Serious Wounds 20"	4	Cure Serious Wounds
"...Grant you Sanctuary"	4	Sanctuary
"...Purify your Blood"	5	Purify Blood
"...Cure Critical Wounds 30"	6	Cure Critical Wounds
"...Destroy Undead 70"	7	Destroy Undead
"...Restore your Limbs"	7	Restore Limbs
"...Cure Mortal Wounds 40"	8	Curse Mortal Wounds
"...Regenerate you"	8	Regeneration

"With Eldritch Force I..."

Figure 5-3.

"...Grant you a Shield 5"	1	Shield
"...Build an Improved Hearth"	1	Improved Hearth
"...Build a Circle of Harmony"	6	Circle of Harmony
"...Build an Extended Hearth"	7	Extended Hearth
"...Grant you Investiture"	7	Lesser Investiture
"...Build a Mystic Lock"	7	Mystic Lock
"...Build a Circle of Power"	9	Circle of Power
"...Build a Prison"	9	Imprison
"...Build a Ward...Ward up"	9	Ward

"I grant you the power of"

Figure 5-4.

"...a Bless 5"	1	Bless
"...an Endow"	1	Endow
"...Illumination"	1	Illumination
"...a Delayed Endow"	2	Delayed Endow
"...a Magic Armor"	2	Magic Armor
"...an Elemental Blade"	4	Elemental Blade
"...a Poison Shield"	4	Poison Shield
"...a Silver Aura"	5	Silver Aura
"...an Elemental Shield"	6	Elemental Shield
"...an Enchanted Blade"	6	Enchanted Blade
"...a <fire, ice, lightning or stone> Shield	7	Guardian of the Four
"...a Displacement"	8	Displacement

"With mystic force I..."

Figure 5-5.

"...Pin you"	2	Pin
"...Repel you"	2	Repel
"...Bind you"	4	Bind
"...Release you"	5	Release
"...Web you"	5	Web
"...Confine you"	8	Confine
"...Banish you"	9	Banish

"I call upon chaos to..."

Figure 5-6.

"...Cause Light Wounds 5"	1	Cause Light Wounds
"...Free Undead"	1	Free Undead
"...Cause Wounds 10"	2	Cause Wounds
"...Control Undead"	2	Control Undead
"...Turn Undead"	2	Turn Undead
"...Cause Disease"	3	Cause Disease
"...Help Undead"	3	Help Undead
"...Cause Serious Wounds 20"	4	Cause Serious Wounds
"...Desecrate you"	4	Desecrate
"...Taint your Blood"	5	Taint Blood
"...Cause Critical Wounds 30"	6	Cause Critical Wounds
"...Create Undead"	7	Create Undead
"...Wither your <Limb>"	7	Wither Limb
"...Cause Mortal Wounds 40"	8	Cause Mortal Wounds
"...Corrupt you"	8	Corruption

"I Call Forth a(n)..."

Figure 5-7.

"...Magic Missile 5"	1	Magic Missile
"...Lightning Bolt 10"	2	Lightning Bolt
"...Ice Bolt 15"	3	Ice Bolt
"...Flame Bolt 20"	4	Flame Bolt
"...Stone Bolt 25"	5	Stone Bolt
"...Lightning Storm 30"	6	Lightning Storm
"...Ice Storm 35"	7	Ice Storm
"...Dragon's Breath 40"	8	Dragon's Breath
"... <flame, ice, lightning or stone> Blast. 45"	9	Eldritch Blast
"...Magic Storm 5"	9	Magic Storm

"I Call Forth Mystic Power to..."

Figure 5-8.

"...Detect Magic"	3	Detect Magic
"...Shield Magic"	5	Shield Magic
"...Reflect Magic"	7	Reflect Magic
"...Dispel Magic"	8	Dispel Magic

"I Summon a Force to..."

Figure 5-9.

"...Fumble <Item>"	1	Fumble
"...Refit this Armor"	3	Refit Armor
"...Shatter <Item>"	3	Shatter
"...Enflame <Item> 20"	6	Enflame
"...Destroy <Item>"	7	Destroy

"I Command..."

Figure 5-10.

"...this animal to be Calm"	1	Calm Animal
"...this animal to be Charmed"	1	Charmed
"...you to Awaken"	4	Awaken
"...you to be Calm"	4	Calm
"...you to Shun Me"	4	Shun
"...you to Silence"	5	Silence
"...you to Sleep"	6	Sleep
"...you to be Charmed"	7	Charm

"I Curse you with..."

Figure 5-11.

"...Weakness"	3	Weakness
"...Destruction"	7	Curse
"...Paralysis"	8	Paralyze

"I Rid you of ..."

Figure 5-13.

"...Weakness"	3	Remove Weakness
"...your Fear"	4	Remove Fear
"...your Physical Affliction"	6	Remove Physical Affliction
"...your Curse"	7	Remove Curse
"...your Drain"	7	Remove Drain
"...Paralysis"	8	Unparalyze

"I grant you the gift of..."

Figure 5-12.

"...Tarrying"	7	Tarry
"...Inspiration"	9	Inspiration
"...Life"	9	Life
"...Death"	9	Death

Awaken



Althena's Mental Clarifier

Level: 4 **Duration:** Instant

This spell awakens the recipient from a *WAYLAY*, any sleep effect, and the charm effects *CALM*, *CALM ANIMAL*, *CALM*, *CALM ANIMAL*, *SHUN*, *SHUN ANIMAL*, *SILENCE*, *FEAR*, and *VAMPIRE CHARM*. It does not in any way affect *ENSLAVEMENT*.

"I command you to Awaken."

arms, including using a weapon or shield, casting a spell, or activating a gas globe. The victim may walk, run, or leave the combat area as desired. This spell does not prevent the victim from being searched or being given a Killing Blow, although a moving victim is unlikely to allow either action.

"With mystic force, I Bind you."



Banish



Lititia's Elemental Banishment

Level: 9 **Duration:** Instant

This spell sends any extraplanar creature from Tyrra to its plane of origin and will keep the creature on its own home plane for 24 Tyrran hours. All items carried by the creature will be left behind unless Spirit Linked. This spell cannot be used to return to Tyrra from another plane.

"With mystic force I Banish you."

Bind



Lasset's Mystic Binding

Level: 4 **Duration:** Line of Sight

This spell snares the victim's arms, binding them straight to its sides. The victim may talk freely, but may not use any game skills requiring use of the

Bless



Bearkiller's Protection

Level: 1 **Duration:** Indefinite

This spell gives the recipient five extra Body Points. These points are the first Body Points lost to damage.

This spell cannot be used to revive an unconscious person or harm an undead.

"I grant you the power of a Bless 5."

Calm



Golem's Charm to Sooth the Savage

Level: 4 **Duration:** 5 Minutes

By means of this spell the caster can calm one target. This makes the target docile and non-aggressive for the duration of five minutes. The target might wander off, head for the tavern for a drink, or simply sit down and rest for a while. They cannot take any aggressive actions while under the effect of this spell, they will not participate in combat nor will they attempt to remove the spell. This is a form of charm and will over-ride any normal behavior so long as it is effective it can be stopped by the ability *RESIST CHARM*. If anyone attacks the target in any way this effect will immediately be dispelled. An *AWAKEN* or *DISPEL MAGIC* will also work to remove this effect.

"I command you to be Calm."



Calm Animal



Xavier's Bestial Soother

Level: 1 **Duration:** 5 Minutes

By means of this spell the caster can calm one creature that is designated as an animal. This calm makes the creature docile and non-aggressive for the duration of five minutes. They cannot take any aggressive actions such as participating in combat nor will they attempt to remove the spell. The animal might wander off or simply sit down and rest for a while. This is a form of charm and will over-ride any normal behavior so long as it is effective it can be stopped by the ability *RESIST CHARM*. If anyone attacks the creature in any way this effect will immediately be dispelled. An *AWAKEN* or *DISPEL MAGIC* will also work to remove this effect.

This will not affect magical animals, hybrid animals, animal men, only ordinary animals, fish, and birds. For example an eagle would be affected but it would not affect a gryphon, a phoenix, or a biata. A bull would be affected but it would not affect a minotaur or a bull scavenger. A horse would be affected but a unicorn would not. This spell has no effect on any being which is not designated as an ordinary animal though it will still trigger a *SHIELD MAGIC* or similar protective.

"I command this animal to be calm."

Cause Critical Wounds



Morgin's Enhanced Aberration

Level: 6 **Duration:** Instant

This spell will deal 30 points of body damage to the target. It does not affect armor. It will cure 30 Body Points to an undead creature.

"I call upon chaos to Cause Critical Wounds 30."

Cause Disease



Korac's Demise

Level: 3 **Duration:** Indefinite

This spell will infect the recipient with a debilitating disease. The infection is not contagious, but makes the target unable to run.

The spell *PURIFY BLOOD* will not cure someone under the effects of this spell. This spell might not be effective against creatures with no metabolism.

"I call upon chaos to Cause Disease."

Cause Light Wounds



Suvina's Minor Aberration

Level: 1 **Duration:** Instant

This spell will deal 5 points of body damage to the target. It does not affect armor. It will cure 5 Body Points of damage on an undead creature.

"I call upon chaos to Cause Light Wounds 5."

Cause Mortal Wounds



Tali's Greater Aberration

Level: 8 **Duration:** Instant

This spell will deal 40 points of body damage to the target. It does not affect armor. It will cure 40 Body Points to an undead creature.

"I call upon chaos to Cause Mortal Wounds 40."

Cause Serious Wounds



Accolon's Corrupter

Level: 4 **Duration:** Instant

This spell will deal 20 points of body damage to the target. It does not affect armor. It will cure 20 Body Points to an undead creature.

"I call upon chaos to Cause Serious Wounds 20."

Cause Wounds



Suvina's Lesser Aberration

Level: 2 **Duration:** Instant

This spell will deal 10 points of body damage to the target. It does not affect armor. It will cure 10 Body Points to an undead creature.

"I call upon chaos to Cause Wounds 10."

Charm



Dalton's Mystic Befriending

Level: 7 **Duration:** 5 Minutes

This spell makes the victim view the caster as his or her best friend in the whole world. While this spell is in effect, no amount of logic or role-playing will convince the victim that he or she has been Charmed, and the victim will not remember the casting of the spell until after it has worn off or been cured.

An attack on the victim by the caster's party will not immediately break the spell, but if the caster cannot come up with a good reason why he or she is not helping to defend the victim, then that will. If the caster attacks the victim, then the spell is broken immediately.

A victim of this spell will not do anything completely against his or her own nature (such as attack his or her own party) unless a very good reason can be given by the caster. The spell does not turn the victim into a mindless robot blindly following orders, but it does require the victim to stay by the side of the new "friend" and listen to his or her

"suggestions." (Note that this assumes that they both speak the same language. You cannot obey a "suggestion" that you don't understand.)

This spell only works on creatures that have a mind as defined by the game. Several creatures (such as lesser undead, golems, or some giant insects) do not have a mind that can be affected by this spell.

After the spell's duration expires, the victim remembers everything that happened except the actual casting of the Charm spell. Depending upon the circumstances, the victim might sometimes realize that he or she had been charmed.

Note that this spell is not strong enough to override *CONTROL UNDEAD*, *FEAR*, *ENSLAVEMENT* or *VAMPIRE CHARM* Table 5-6 on page 64.

"I command you to be Charmed."



mean the animal will do anything they are not specifically trained to do.

This spell is a type of charm and can be resisted with the ability *RESIST CHARM*, and it can be cured with an *AWAKEN* spell or *DISPEL MAGIC* spell. Stronger charms such as *VAMPIRE CHARM* or *ENSLAVEMENT* will override its effects Table 5-6 on page 64.

This will not affect magical animals, hybrid animals, animal men, only ordinary animals, fish, and birds.

For example an eagle would be affected but it would not affect a gryphon, a phoenix, or a biata. A bull would be affected but it would not affect a minotaur or a bull scavenger. A horse would be affected but a unicorn would not. This spell has no effect on any being which is not designated as an ordinary animal though it will still trigger a shield magic or similar protective.

"I command this animal to be Charmed."

Charm Animal



Xavier's Animal Friendship

Level: 3 **Duration:** 5 Minutes

This spell allows the caster to charm a single creature which must be an animal. This spell duplicates the *CHARM* spell, except that it may only be cast on ordinary animals. Since the Animal will not understand the common tongue this in general only keeps the caster safe from the animal attacking him. If the caster is attacked the animal will generally attempt to defend him and if the caster interposes himself between the animal and another target the animal will understand that it shouldn't attack the target. If the animal has been trained to follow commands it will listen to the caster as if he were the one who normally gives the commands and will perform any commands he is trained to at the request of the caster, this does not

Circle of Harmony



Edgar's Symbolic Hearth

Level: 6 **Duration:** 1 Hour

The caster may draw out or construct an intricate circle which acts as a prepared hearth, for the school of magic from which this spell was cast, without the need to be indoors. The circle must consist of a circle within a circle to form a circular band. Between the two circles their must be no less than eight symbols or glyphs. The circle must be fully prepared before the spell is cast. The maximum radius of the outer circle is six feet, and the inner circle must be at least six inches smaller in radius. The area within the outer circle represents the area of effect. The spell lasts for one hour or until the circle is in part or

whole erased, pulled apart, destroyed, or a *DISPEL MAGIC* is cast upon the phys-rep. The caster must place an individually recognizable styled "H" in the center of the circle as if it were a hearth indicating it is active, the "H" is OOG the way a "W" is for a ward. The circle remains active even if the caster leaves it but if dispelled or otherwise disrupted the "H" must be removed. A player must confirm their "H" is still present before using a *CIRCLE OF HARMONY*. A player may cast this spell from both schools of magic in order to have the effect of the hearth for both schools. If they do this the "H" must reflect this to them. Multiple characters can have this effect active on the same area, but each *CIRCLE OF HARMONY* must have its own "H" which must be recognizable by the player who cast it and distinct from any others.

"With eldritch force I build a Circle of Harmony."

Circle of Power



Lania's Power Circle

Level: 9 **Duration:** 10 Minutes

This spell allows the caster to inscribe a circle for protection. Before casting the spell, a visible physical representation of the circle must be drawn in the dirt or represented by something physical (chalk, string, etc). A shield may not be used as the physical representation, including attaching a circle to the shield or marking a circle on it in any way. If any object not in the possession of a character (such as a table or chair) would obstruct the circle going up then the spell will fail and be wasted. Any character not fully within the circle representation when the spell is cast is ejected and must move to outside the boundary. The representation is in-game. The caster must be fully within the completed circle before casting. The circle may be a maximum of 6 feet in radius and must be in the shape of a circle. No effect, person or object may pass across the circle while it is active.

The Circle will last for 10 minutes, though it may be dropped by the caster at any time if he or she touches the circle and states "Circle down." The statement "Circle down" is out-of-game, although

any observers who hear the statement are aware that the Circle was dropped, and they might know who dropped it.

The Circle will also go down if the caster leaves the Circle (via spirit walk, gate, rift, etc.) or dies (needing a Life spell). The Circle is not affected by Dispel Magic.

Circle of Power and Ward effects may not overlap in any way, though they may be concentric.

"With eldritch force, I build a Circle of Power."

Confine



Mannaria's Advanced Eldritch Binder

Level: 8

Duration: Line of Sight

This spell snares the arms of its victim, binding them straight to its sides, and immobilizes the victim completely from the neck down making them helpless. The victim may talk freely, but may not use any game skills requiring use of the arms, including using a weapon or shield, casting a spell, or activating a gas globe. The victim may not walk, run, or be moved in any way. Any item the victim is holding cannot be dropped. However, since the effect allows the victim to be searched, anyone else can choose to physically remove a hand-held item from the victim by simply "SEARCHING" them. Even a victim with Superhuman Strength cannot prevent himself from being "SEARCHED" in this manner.

This spell does not prevent the victim from being given a Killing Blow.

"With mystic force, I Confine you."



Control Undead



Yivik's Sphere of Coercion

Level: 2

Duration: 5 Minutes

This spell allows the caster to control one lesser undead for 5 minutes. Tasks may not involve any sentient thought higher than an animal: "Guard this" is fine, but "Count all the leaves on that tree" requires sentience and will not work. The most recent Control Undead effect takes precedent, if there is a conflict. This spell will not affect a living target, although it will remove a living person's SHIELD MAGIC or REFLECT MAGIC. This effect is stronger than CALM, CALM ANIMAL, CHARM, CHARM ANIMAL, SHUN, SHUN ANIMAL or FEAR. The most recent CONTROL UNDEAD, VAMPIRE CHARM or ENSLAVEMENT EFFECT will take precedent if there is a conflict Table 5-6 on page 64.

"I call upon chaos to Control Undead."

Corruption



Balvar's Corrupting Touch

Level: 8

Duration: 1 Minute

This spell restores an undead target or other target healed by necromancy or chaos to his or her full body points. Once the spell is successfully cast, the target will begin to regenerate as per the rules of the special ability REGENERATION. CORRUPTION requires that the character stand or sit in one place for one minute and concentrate. If this process is interrupted before its completion, the spell is lost for no effect. The target may not be restored to a total of body higher than is appropriate for his race and level via this spell. This spell may not be used to aid a living character in any way. This spell only affects targets which are healed by necromancy or chaos. This spell does not remove any other

negative effects. This spell is the reverse of REGENERATION.

"I call upon chaos to Corrupt you."

Create Undead



Necro's Re-animator

Level: 7

Duration: 5 Minutes

This spell only works on a corpse that has not previously been animated, and will pull the character's spirit back to reanimate its former body. The resulting zombie will then follow the caster's commands as if a CONTROL UNDEAD spell had been cast upon it. Note that this spell must be cast within the five minute period between a character's death and the point where the spirit heads to the Earth Circle for resurrection.

This spell transforms the individual into a mindless berserker who will fight at their normal speed until reduced to no hit points or until ordered to stop by the caster. The creature's visual appearance does not change.

While Created as an undead the five minute count until resurrection is suspended.

If the zombie is reduced to zero Body Points or takes effect from a DISPEL MAGIC, then the spell ends and the resurrection count resumes where it left off. The spirit will remember nothing of the time spent as a zombie.

The zombie created will have the maximum body points the victim had in life, as well as any armor that is left on the corpse. The new zombie is immune to all alchemical substances and the spells CALM, CALM ANIMAL, CHARM, CHARM ANIMAL, DEATH, LIFE, PARALYZE, SHUN, SHUN ANIMAL, SLEEP and TAINT BLOOD. It will be affected by all undead affecting spells such as TRAP UNDEAD and SANCTUARY. The zombie can use no skills other than base weapon skills: no CRITICAL ATTACKS, no spells, no WAYLAYS. It will do damage based on its weapons only. It cannot cast spells nor converse. The zombie is healed by numerical spells with "Chaos" in the incant and is damaged by numerical spells with "Earth" in the incant. See page 137 for stat cards.

"I call upon chaos to Create Undead."

Cure Critical Wounds



Morgin's Enhanced Restorative

Level: 6 **Duration:** Instant

This spell will restore up to 30 points of body damage but never more than a character's maximum. It will restore an unconscious or dying character but will not resurrect a dead one. Against undead, this spell will deal 30 points of body damage.

"I call upon the earth to Cure Critical Wounds. 30."



Cure Disease



Korac's Eldritch Infusion

Level: 3 **Duration:** Instant

This spell will cure a character infected with a disease.

"I call upon the earth to Cure Disease."

Cure Light Wounds



Suvina's Minor Restorative

Level: 1 **Duration:** Instant

This spell will restore up to 5 points of body damage but never more than a character's maximum. It will restore an

unconscious or dying character but will not resurrect a dead one. Against undead, this spell will deal 5 points of body damage.

"I call upon the earth to Cure Light Wounds. 5."

Cure Mortal Wounds



Tali's Greater Restorative

Level: 8 **Duration:** Instant

This spell will restore up to 40 points of body damage but never more than a character's maximum. It will restore an unconscious character but will not resurrect a dead one. Against undead, this spell will do 40 points of body damage.

"I call upon the earth to Cure Mortal Wounds. 40."

Cure Serious Wounds



Accolon's Aberration

Level: 4 **Duration:** Instant

This spell will restore up to 20 points of body damage but never more than a character's maximum. It will restore an unconscious character but will not resurrect a dead one. Against undead, this spell will do 20 points of body damage.

"I call upon the earth to Cure Serious Wounds. 20."

Cure Wounds



Suvina's Lesser Restorative

Level: 2 **Duration:** Instant

This spell will restore up to 10 points of body damage but never more than a character's maximum. It will restore an unconscious character but will not resurrect a dead one. Against undead, this spell will do 10 points of body damage.

"I call upon the earth to Cure Wounds. 10."

Curse



Trisilia's Curse

Level: 7 **Duration:** Indefinite

This spell will cause the victim to take double damage from all attacks that would affect them. It can be removed by a *REMOVE CURSE* or a *DISPEL MAGIC*. The damage taken is doubled before any Spell Defenses are applied. The Curse effect does not lower a creature's Threshold, nor does it make the creature affected by additional attacks that would not normally affect it.

"I Curse you with destruction."

Death



Angelica's Spirit Evictor

Level: 9 **Duration:** Instant

This spell causes the victim's spirit to flee its body, if it has a metabolism. Any armor the character was wearing is still intact, but any spells active on the victim will disappear. This spell brings a character to death (see Table 2-2 on page 23), and the only thing that will save the victim is a *LIFE* spell.

"I grant you the gift of Death."

Delayed Endow



Midtguard's Delayed Ogrestrength

Level: 2 **Duration:** Indefinite

This spell endows the recipient with the ability to do two extra points of damage for one swing, if it hits the target. The total damage must be announced while swinging. Once called, the spell is used up whether the blow was successful or not. Unlike a normal Endow, the recipient may choose when to use a *Delayed Endow*.

The recipient may also expend this spell to rip from Pin as per the monster ability. *DELAYED ENDOW* will not benefit creatures that have Superhuman Strength greater than +1, and will only add +1 to a creature with +1 strength.

The spell may be stacked with other Blade Effects see Table 5-6 on page 64 (maximum three spells total), but the spells will only work one at a time. It does not

allow you to hurt a monster that can only be damaged by magical weapons.

"I grant you the power of a Delayed Endow."

Desecrate



Hector's Vilification

Level: 4 **Duration:** Indefinite

The recipient is protected against all non-ranged attacks from living creatures. Ranged attacks (such as spells, missile weapons, and gas globes) can affect the recipient. This spell will remain in effect as long as the subject's hands are crossed on their chest and they do not receive any body damage.

If you are unsure if an attacker is living or not, you will be affected by them. You may not call a Hold or otherwise go out of game to ascertain their status.

The character with a *Desecrate* active may use no game abilities except touch-casting on themselves. Attempting to pick up an item will disrupt the spell.

"I call upon chaos to Desecrate you."

Destroy



Zalinarik's Improved Shattering Force

Level: 6 **Duration:** Instant

This spell will render any tagged object up to the size of a normal door, useless. It can not be used to create a door-sized hole in an object larger than a door.

It can target a suit of armor, although the *SHIELD* spell, and *DEXTERITY ARMOR* will be unaffected. Armor successfully destroyed will require the tag to be discarded as useless. This spell will not work on an item that has been Rendered Indestructible.

It may also be cast at a creature to affect such an item, or to target the creature directly as some creatures may be harmed by this spell.

If the caster does not specify an item or if the spell is received from a carrier attack, then it is the target's choice as to which currently non-rendered item matching the description becomes Destroyed. If no

item exists call "got it" see stacking spells "Stacked Effects" on page 47.

Destroying an item that has other items within, hanging from, or fastened to it will destroy all of the items. This spell will destroy not only a shield but also any scrolls, or Gas globes, etc. attached to the back. Destroying a trapped door or item will set off and destroy the trap as well.

After the item is destroyed the prop for the item remains, but is unusable.

"I summon a force to Destroy <item>."



Destroy Undead



Necro's Abomination

Level: 7 **Duration:** Instant

This spell will destroy any one lesser undead creature. Greater undead will take 70 points of body damage. This spell will not affect a living target, although like all spells it will remove a living person's *SHIELD MAGIC* or *REFLECT MAGIC*.

"I call upon the earth to Destroy Undead. 70."

Detect Magic



Shalizar's Enchanted Magesight

Level: 2 **Duration:** Instant

Casting this spell on an object or person will reveal to the caster and only the caster if any magic is present. Any visible items worn or carried by the target will be revealed, but items hidden under clothing or in bags or boxes will not be. This spell will cover up to a door sized area.

The subject must tell the caster which (if any) magic items are visible, and which schools of magic are present on all of the detected items (Earth, Celestial, Both or Other.) If the subject has any spell defenses currently active (such as *ENDOW* or *MAGIC ARMOR*), then the subject will detect as magical to the caster. This does not overshadow any items on the person. In other words, the fact that a subject has a *SHIELD* spell upon him or her does not cover the fact that a magic item is worn.

If cast upon a *CIRCLE OF POWER* or *WARD*, this spell will not only detect the target's school, but also whether the target's duration is ten minutes, one hour, one year or two years.

"I call forth mystic power to Detect Magic."

Dispel Magic



Killraven's Diabolical Disrupter

Level: 8 **Duration:** Instant

This spell will dispel all active non-formal magical effects on a given creature or object unless specifically noted by the spell description. A *SHIELD MAGIC* or *REFLECT MAGIC* will protect all other spells on a person from a *DISPEL MAGIC*, but will be used up in the process. A *DISPEL MAGIC* potion isn't stopped by a *SHIELD MAGIC* or a *REFLECT MAGIC*, and will dispel those spells and all others spells active upon the drinker.

"I call forth mystic power to Dispel Magic."

Displacement



Rigalinion's Camouflage

Level: 8 **Duration:** Indefinite

This spell grants the caster, and only the caster, a shield against the first effect that hits them. It may not be cast upon another target. This will always be the first protective spell lost if it is appropriate to defend against an attack and will be used before a *SHIELD MAGIC*, *ELEMENTAL SHIELD*, *MAGIC ARMOR* or any other automatic protective effect, though a Formal Magic Cloak or Bane can be used before a *DISPLACEMENT*. The caster may choose to accept a touch cast effect under the protection of this spell. When struck by an appropriate attack the defense is automatically triggered. *DISPLACEMENT* cannot be Imbued via Formal Magic Cantrip, placed into a Magic Item of any kind (including a Spell Store item), or by any other means transferred to someone else to cast. The proper call for this defense is "Phase."

"I grant you the power of a Displacement."

Dragon's Breath



Arcevol's Draconian Enchantment

Level: 8 **Duration:** Instant

This spell allows the caster to cast a bolt of magical fire, dealing 40 hit points of eldritch fire damage to the target. The fire is eldritch in origin and will not otherwise set anything alight.

"I call forth a Dragon's Breath. 40."

Eldritch Blast



Diranda's Energy Expeller

Level: 9

Duration: Instant

This spell allows the caster to affect a target with a bolt of magical fire, ice, lightning or

stone dealing 45 hit points of eldritch damage. The caster may choose which type of damage to throw at the time of the casting, signifying such through the verbal. The damage will not otherwise set anything alight or freeze anything. This spell may also be called <Fire, Ice, Lightning or Stone> Blast for the purposes of magic deliverance, monster abilities, magic items, and similar situations.

"I call forth a(n) <flame, ice, lightning or stone> Blast. 45."

Elemental Blade



Arcevol's Improved Elemental Conjunction

Level: 4 **Duration:** Indefinite

This spell allows the recipient to do five extra points of damage for one swing if the blow is successful. The spell is used up whether the blow is successful or not. Unlike an *ENDOW*, the recipient may choose when to use an *ELEMENTAL BLADE*. The recipient must announce the total damage while swinging.

This damage will not set anything alight, freeze it, turn it to stone, etc. The extra damage comes from the spell's eldritch effect, and its bonus can added fully to damage done by creatures with Superhuman Strength.

The spell may be stacked with two other Blade Effects see Table 5-6 on page 64, but the spells will only work one at a time. It does not allow you to hurt a monster that can only be damaged by magical

weapons.

When using this spell, you may call out "Fire, Ice, Lightning or Stone" as a damage type. The user of the spell chooses the type of damage done. The damage type is chosen when the damage is added to the weapon blow.

"I grant you the power of an Elemental Blade."

Elemental Shield



Peldin's Elemental Barrier

Level: 6 **Duration:** Indefinite

This spell protects the recipient from the next effect with the word "elemental" in the verbal. It is then immediately used up. When used, the call is "Elemental Shield."

"I grant you the power of an Elemental Shield."

Empathic Healing



Oleander's Self Sacrifice

Level: 2 **Duration:** Instant

This spell allows the caster to transfer one detrimental effect from the target to the caster. The effects this spell may transfer to the caster are *DISEASE*, *CURSE*, *PARALYZE*, *SILENCE*, *SLEEP*, *TAINT BLOOD*, *WEAKNESS*, *WITHER LIMB*, *DRAIN*, *DRAIN LIFE*, *Feeblemind*, *Hallucinoid*, *Intoxicant*, *Nausea*, *Paralyze*, and *Vertigo*. No effect not on this list may be transferred using

Empathic Healing. The caster cannot use spell protectives or combat abilities like *DODGE* or *PHASE* to negate the effect upon them. If the effect is not inflicted upon the caster because of immunity to the effect, a formal magic defense, or a magical item, then the spell fails. The caster must take the effect or use a racial resist for the spell to succeed. The caster must begin the duration of the negative effect they take upon themselves from the point they take the effect not when



it was originally cast on the one they removed it from.

"I call upon the earth to Transfer <effect>"

Enchanted Blade



Turing's Aura of Enchantment

Level: 6 **Duration:**

Indefinite

This spell allows the recipient to use the "Magic" weapon type against one opponent for the one battle, in the manner of a *Critical Attack* page 35. The recipient may choose when to use the ENCHANTED BLADE, and must announce the total damage of the swing while saying "Magic" instead of "Normal" or "Silver."

The spell may be stacked with other Endow/Blade spells (maximum three spells total), but the spells will only work one at a time. ENCHANTED BLADE will have no effect with a DAMAGE AURA OR MAGIC AURA.

"I grant you the power of an Enchanted Blade."

Endow



Barantur's Charm of Ogre Strength

Level: 1 **Duration:** Indefinite

This spell endows the recipient with the ability to do three extra points of damage on the next swing, if it hits the target. The total damage must be announced while swinging. Once called, the spell is used up whether the blow was successful or not. The spell may be stacked with two other Blade Effects see Table 5-6 on page 64, but the spells will only work one at a time. It does not allow you to hurt a monster that can only be damaged by magical weapons.

Endow will not benefit creatures that have Superhuman Strength greater than +1, and will only add one to a creature with +1 strength.

"I grant you the power of an Endow."



Enflame



Bester's Stumbling Flame

Level: 6 **Duration:** 5 Seconds

This spell causes any hand-held item to burst into fire for 5 seconds, dealing 20 points of eldritch fire damage to the person or creature carrying the item as if they were struck by a FLAME BOLT. It will also act as a FUMBLE spell towards that item if the creature was affected by the fire. A defense against Fire will negate this spell.

"I summon a force to Enflame <item>. 20."

Extended Hearth



Edgar's Overlying Hearth

Level: 7 **Duration:** Indefinite

When this spell is cast on an existing circle of power or ward it will allow the circle or ward to act as a prepared hearth for the caster for the school this spell was cast from. The prepared hearth will last as long as the circle or ward if they are not

already extended through formal magic. If they are already extended through formal magic this spell will last for five days. The extended hearth is only dispelled if the circle or ward is destroyed, a DISPEL MAGIC will not suffice.

When cast the caster must place an individually recognizable stylized "H" up on the door or wall or within the center of the circle obviously indicating that a hearth is in affect, the "H" is OOG the way a "W" is for a ward. If the effect is dispelled the "H" must be removed. A player must confirm their "H" is still present before using an extended hearth. A player may cast this spell from both schools of magic in order to have the effect of the hearth for both schools. If they do this the "H" must reflect this to them. Multiple characters can have this effect active on the same area, but each EXTENDED HEARTH must have its own "H" which must be recognizable by the player who cast it and distinct from any others. This spell cannot be thrown.

"With eldritch force I build an Extended Hearth."

Fumble



Ganmarek's Limited Curse of Clumsiness

Level: 1 **Duration:** 5 Seconds

This spell causes the target to be unable to use a specific hand-held item. Only the item named may be fumbled in this manner. Saying a general description like "weapon" is fine, although if the target is holding two items which match the description, then it is the target's choice as to which they cannot use. A shield is not considered a "weapon" for purposes of this spell. Spell packets cannot be affected, while orange gas globes can be affected.

"I summon a force to Fumble your <item>."

Flame Bolt



Folson's Elemental Flamestrike

Level: 4 **Duration:** Instant

This spell deals 20 points of eldritch fire damage to the victim.

"I call forth a Flame Bolt. 20."

Free Undead



Morien's Malignant Mistake

Level: 1 **Duration:** Instant

This spell free an undead creature from the effects of a *TRAP UNDEAD* spell. This spell will not affect a living target, although it will remove a living person's *SHIELD MAGIC* or *REFLECT MAGIC*.

"I call upon chaos to Free Undead."

Guardian of the Four



Janos' Specific Protection

Level: 7 **Duration:** Indefinite

This spell grants a shield to fire, ice, lightning, or stone as determined by the caster at the time of casting. This will nearly always be the first protective spell lost if it is appropriate to defend against an attack and will be used before a *SHIELD MAGIC*, *ELEMENTAL SHIELD*, *MAGIC ARMOR* or any other automatic protective effect other than *DISPLACEMENT* which still comes before this spell. This spell will defend against packet delivered attacks and weapon delivered attacks as long as the damage or effect type is appropriate. For combined effects such as *ENFLAME* where the spell is both a fire attack and another effect this spell will protect against both. A player may have only a single casting of this spell upon them if another casting is placed upon them it will replace the prior one. When struck by an appropriate attack the spell automatically goes off the target may not choose to accept the spell and save this protection for later. This protective will be set off prior to any more general protective such as a *SHIELD MAGIC*. The caster may choose to accept a touch cast effect under the protection of this

spell. When used, the call is "<fire, ice, lightning, stone> Shield."

"I grant you the power of a <fire, ice, lightning or stone> Shield."

Harm Undead



Doria's Bane of the Doomed

Level: 3 **Duration:** Instant

This spell will deal 30 points of body damage to an undead creature. This spell will not affect a living target, although like all spells it will remove a living person's *SHIELD MAGIC* or *REFLECT MAGIC*.

"I call upon the earth to Harm Undead. 30."

Help Undead



Doria's Boon of the Doomed

Level: 3 **Duration:** Instant

This spell will heal an undead creature for 30 points of body damage. This spell will not affect a living target although like all spells it will remove a living person's *SHIELD MAGIC* or *REFLECT MAGIC*.

"I call upon chaos to Help Undead. 30."

Ice Bolt



Swansona's Cold Strike

Level: 3 **Duration:** Instant

This spell does 15 points of eldritch ice damage to the victim.

"I call forth an Ice Bolt. 15."

Ice Storm



Kalliestro's Elemental Maelstrom

Level: 7 **Duration:** Instant

This spell does 35 points of eldritch ice damage to the victim.

"I call forth an Ice Storm. 35."

Illumination



Alva's Illuminator

Level: 1 **Duration:** 5 Days

This spell produces a glowing light and allows the caster to kindle a light wand. The light can then be used by anyone. It will not work without a phys-rep. You cannot cast a *ILLUMINATION* spell at a person or tree and have the person or tree glow. There must be a properly dimmed flashlight or other out-of-game light source provided.

The spell lasts until it is dispelled. If using a flashlight for this spell, the lens of the flashlight must be covered by a cloth, tissue paper or a gel to diffuse the light. Do not shine the light in anyone's face. This spell can *not* be thrown.

"I grant you the power of Illumination."

Imprison



Midtguard's Forceful Imprisonment

Level: 9 **Duration:** 10 Minutes

This spell seals the victim into a rigid, form-fitting and unbreakable barrier, trapping them within. The victim cannot move, speak, touch-cast, Gypsy Curse, or perform any game skills requiring movement.

The spell lasts for ten minutes, but may be dropped by the caster at any time if he or she touches the victim and states "Imprison down." This statement is out of-game, and can be used even if the caster is Silenced or inside the *IMPRISON*. Any observers who hear the statement are aware that the *IMPRISON* was dropped, and they might know who dropped it. A *DISPEL MAGIC* will bring down the *IMPRISON*, but will not dispel any other spell effects on the creature inside.

Any creature sealed within an *IMPRISON* spell cannot be affected by any effect or damage, nor can they be moved.

A victim of the *IMPRISON* is completely aware of his or her surroundings and unless unconscious or otherwise impaired will remember all that occurred while *IMPRISONED*.

This spell will prevent the victim from



being searched and only the caster may deliver a Killing Blow to the recipient with the phrase "Imprison Down" after the three count. If the Killing Blow fails (for example, if the creature inside is immune to the caster's attack), then the IMPRISON will drop as soon as the Killing Blow is completed and the creature may then defend itself.

"With eldritch force I build a prison."

Improved Hearth



Edgar's Enhancing Area

Level: 1 **Duration:** 1 Hour

This spell must be cast on an area already prepared as a hearth using the skill PREPARE HEARTH. Once cast by the character who prepared the hearth the duration of the hearth is extended to 1 hour but only works for the school of magic from which it was cast. The hearth no longer ends if the caster leaves it, is targeted with a DISPEL MAGIC, or dies but it will end if the room is targeted with a DISPEL MAGIC. When cast the caster must place an individually recognizable stylized "H" up on the door or wall obviously indicating that a hearth is in affect, the "H" is OOG the way a "W" is for a ward. If the room is dispelled the "H" must be removed. A player must confirm their "H" is still present before using an improved hearth. A player may cast this spell from both schools of magic in order to have the effect of the hearth for both schools. If they do this the "H" must reflect this to them. Multiple characters

can have this effect active on the same area, but each IMPROVED HEARTH must have its own "H" which must be recognizable by the player who cast it and distinct from any others. This spell can not be thrown.

"With eldritch force I build an Improved Hearth"

Inspiration



Oracle's Rite of Renewal

Level: 9 **Duration:** Instant

The recipient chooses one daily use skill that they have purchased with build points and that they have already used that day to be refreshed. This spell will restore only normal times per day skills including a single spell slot. It will not renew powers from items or production skills or special abilities of any kind, only skills conforming to the current edition of the NERO rules. It will renew a single level of formal magic if the target so chooses but only for use in casting a Cantrip not for casting of formal magic. If used to renew a CRITICAL SLAY or ASSASSINATE it will renew only the 100 slay or assassinate it will not renew a 200 slay or assassinate selectively unless all other slays or assassinations have been renewed through some other means first. A single target may only be affected by one inspiration for each time they can study to reset their skills (This means once per reset) and spells and casting the spell on them again will have no effect until after the next reset point.

"I grant you the gift of Inspiration"

Lesser Divestiture



Raveloch's Sundering Eldritch Forge

Level: 7 **Duration:** Instant

This spell will Divest a person from a WARD or MYSTIC LOCK. The caster of this spell must already be Invested. If Divesting from a Ward, the caster and the subject must both be within the WARD at the time of casting. If Divesting from a MYSTIC LOCK, the caster and subject must both be touching the Mystic Locked chest at the time of casting. The subject's name must then be removed from the appropriate marshal notes. A person Divested is no longer Invested in the WARD or MYSTIC LOCK. This spell can not be thrown.

"With eldritch force I remove your Investiture"

Lesser Investiture



Raveloch's Attuning Eldritch Forge

Level: 7 **Duration:** 5 Days

This spell will Invest a person into a WARD or MYSTIC LOCK. The caster of this spell must already be Invested. If Investing into a WARD, the caster and the subject must both be within the WARD at the time of casting. If Investing into a MYSTIC LOCK, the caster and subject must both be touching the MYSTIC LOCKED chest at the time of casting. The subject's name must then be added to the appropriate marshal notes. This spell can not be thrown.

"With eldritch force I grant you an Investiture"

Life



Angelica's Death Bane

Level: 9 **Duration:** Instant

This spell must be cast within five minutes of a creature's death. It restores the creature to one Body Point and the creature is not forced to resurrect. This spell is the only thing that can save someone who has been given a killing blow or hit by a DEATH effect.

This spell will not normally affect

a living target or an undead creature, although it will remove a living person or undead creature's *SHIELD MAGIC* or *REFLECT MAGIC*.

"I grant you the gift of Life."

Lightning Bolt



Hanson's Thunderbolt Generator

Level: 2 **Duration:** Instant

This spell does 10 points of eldritch lightning damage to the victim.

"I call forth a Lightning Bolt. 10."

Lightning Storm



Hanson's Maelstrom Effect

Level: 6 **Duration:** Instant

This spell does 30 points of eldritch lightning damage to the victim.

"I call forth a Lightning Storm. 30."



Magic Armor



Robalyn's Mystic Protection Field

Level: 2 **Duration:** Indefinite

A *MAGIC ARMOR* spell will protect the recipient from the next single strike by a NERO-safe weapon or any attack with the word "physical" in the verbal. The recipient must state "Magic Armor." The attack and the *MAGIC ARMOR* will then be expended. This does not protect against a Killing Blow or a fall, nor does it work against any traps other than weapon traps. A *MAGIC ARMOR* will be blown even if the amount of damage called is "zero."

"I grant you the power of a Magic Armor."

Magic Missile



Cornelius' Mystic Projectile

Level: 1 **Duration:** Instant

This spell does 5 points of eldritch damage to the victim.

"I call forth a Magic Missile 5."

Magic Storm



Analyzix's Mystic Bombardment

Level: 9 **Duration:** Concentration

This spell allows the caster to continuously channel eldritch energy so long as their feet remain planted. At the time of casting, the caster must plant both feet. As long as both feet remain planted and Concentration is maintained, the

caster may throw a packet after completing the incant "Magic Storm 5" While the spell is in effect, the caster can perform no other skill nor cast any other spell,

nor activate magical items, but can speak. Each packet thrown acts as a separate spell which causes 5 points of eldritch damage to the target.

"I call forth a Magic Storm 5, Magic Storm 5, Magic Storm 5. . ."

Mystic Lock



Andraya's Dimensional Box

Level: 7 **Duration:** 5 Days

This spell magically seals a single box or chest which becomes immobile once the spell is cast. It will not work on a container that already has magical properties. The size of the box is limited to a rectangular solid 3ft x 3ft x 6ft and no larger.

No effect, person or object may pass through the *MYSTIC LOCK* unless as described below.

Anyone touching the *MYSTIC LOCK* during the casting of the spell will receive an *INVESTITURE* to the *MYSTIC LOCK*. The names of the people Invested must be written in the room's marshal notes.

INVESTITURE in a *MYSTIC LOCK* allows you to place and retrieve items within the chest, however no people or dead bodies may ever be placed inside a *MYSTIC LOCK*. *MYSTIC LOCK* is not affected by *DISPEL MAGIC*.

The chest must be visibly marked to indicate the presence of the *MYSTIC LOCK* by attaching a large clearly visible "W".

You may not *MYSTIC LOCK* a box in order to obstruct or hinder movement. This spell cannot be thrown.

"With eldritch force I build a Mystic Lock."

Paralyze



Nyrina's Nerve Blocker

Level: 8 **Duration:** 5 Minutes

This spell completely immobilizes the victim. The target may not move any part of their body and may be given a Killing Blow while thus trapped. If the victim is rendered unconscious or someone attempts to pose them, they will collapse to the ground but will remain Paralyzed. An *UNPARALYZE* spell or a *DISPEL MAGIC*

will release a victim from the *PARALYZE*. A *RELEASE* spell will not work. This spell only works on creatures that have a metabolism. Some creatures such as undead, golems or some elementals are not affected by this spell.

"I curse you with Paralysis."

Pin



Peranore's Minor Binding

Level: 2 **Duration:** Line of Sight

This spell will root the target's right foot in place. The target may pivot their body 360 degrees but may not move their right foot. The *PIN* can be removed with a *RELEASE SPELL* or a *DISPEL MAGIC*.

"With mystic force I Pin you."

Poison Shield



Klarissa's Poison Protector

Level: 4 **Duration:** Indefinite

This spell protects the recipient from the next attack with the word "poison" in the verbal. It is then

immediately used up. It will not protect against ingested elixirs. When used, the call is "Poison Shield."

"I grant you the power of a Poison Shield."

Purify Blood



Vorin's Antidote

Level: 5 **Duration:** Instant

This spell will cleanse the recipient's blood, removing any and all alchemical effects or monster effects with the word "poison" in the verbal that are currently active on the character, even beneficial ones. It will also remove the effects *BERSERK*,

FEEBLEMIND, *FORGET-IT-WELL*, *FORGET-ME-NOT*, *HALLUCINOID*, *INTOXICANT*, *NAUSEA*, *PARANOIA*, AND *VERTIGO* regardless of the delivery type. It will not remove a *POISON SHIELD* or *ENSLAVEMENT*. It is also a very good in-game cure for an in-game hangover.

PURIFY BLOOD will not cure any

damage previously wrought by a numerical poison effect.

"I call upon the earth to Purify your Blood."

Refit Armor



Ulin's Smithing Surrogate

Level: 3 **Duration:** Instant

This spell instantly refits armor to its full value. This spell only works on actual physical armor.

"I summon a force to Refit this armor."

Reflect Magic



Kincaid's Enchantment Reflection

Level: 8 **Duration:** Indefinite

This spell will reflect the next spell cast at the recipient back upon the caster, after which it is used up. The recipient must say "Reflect Magic" to inform the caster that the spell was returned.

The original caster is still the caster of the spell. This spell lasts until used up or *DISPELLED*, and cannot be used in conjunction with a *SHIELD MAGIC*.

If you have a *REFLECT MAGIC* active, you may still "accept" spells that are touch-cast. You cannot "accept" thrown spells. See "Spell Disruption" on page 46 for more details.

Reflect Magic will only work on spells delivered via packet, Glyph (See the *Formal Magic* section for more details), or Spell Strike.

"I call forth mystic power to Reflect Magic."

Regeneration



Balvar's Healing Grace

Level: 8 **Duration:** 1 Minute

This spell restores a living target to his or her full body points. Once the spell is successfully cast, the target will begin to regenerate as per the rules of the special ability *REGENERATION*. *REGENERATION* requires that the character stand or sit in



one place for one minute and concentrate. If this process is interrupted before its completion, the spell is lost for no effect. The target may not be restored to a total of body higher than is appropriate for his race and level via this spell. This spell may not be used to aid a dead character in any way. This spell only affects targets which are healed by earth magic. This spell does not remove any other negative effects.

"I call upon the earth to Regenerate you."

Release



Hiro's Splendid Unbinding

Level: 5 **Duration:** Instant

This spell will release a creature caught in a *PIN*, *BIND*, *WEB* or *CONFINE* effect, as well as negating all active *PASTE OF STICKINESS* effects upon the creature. It will not free someone who has been *PARALYZED* or *IMPRISONED*.

A *RELEASE* spell can also be used to free someone bound by any non-magical means (such as handcuffed, tied up, or gripped by a tentacle). It will not unlock a cell door, but will open a stock if the creature is locked in one.

"With mystic force I Release you."

Remove Curse



Trisilia's Charm

Level: 7 **Duration:** Instant

This spell will cancel a Curse spell but will not restore any Body Points lost. It will not rid anyone of a *GYPSY CURSE*.

"I rid you of your Curse."

Remove Drain



Enigma's Restorative

Level: 7 **Duration:** Instant

The target of this spell is cured of the drain effect but not of the *DRAIN LIFE* effect which still requires a *LIFE* spell to remove.

"I rid you of your Drain."

Remove Fear



Elder's Spine of Steel

Level: 4 **Duration:** Continuous

This spell will remove the effect fear from the target.

The caster may continue to perform the verse without actually casting the spell on a target each time the verse is stated without disrupting the spell.

"I rid you of your fear."

Remove Physical Affliction



Daniel's Invigorating Corporeal Restoration

Level: 6 **Duration:** Instant

This spell will remove all currently active effects with "Physical" in the verbal from the target. Damage is not cured.

"I rid you of your physical affliction."

Remove Weakness



Tyrr's Damage Restorer

Level: 3 **Duration:** Instant

This spell will remove all active *WEAKNESS* effects on a creature

"I rid you of Weakness."

Repel



Jondar's Force of Repulsion

Level: 2 **Duration:** Concentration

This spell requires the caster to hit a target and hold the hand used to throw the packet palm out, facing the recipient. The victim and the target must then stay at least 10 feet apart while the spell is in effect.

When the spell is first cast, the recipient must move 10 feet away from the caster. After that, neither the recipient nor the caster may approach within 10 feet of each other; the caster cannot approach the recipient any easier than the recipient may approach the caster. Either could back away.

If it is impossible for the recipient to

move more than 10 feet away from the caster because of physical obstructions when the spell is cast, the caster must first attempt to move 10 feet away from the recipient.

The caster must hold out a hand, palm out, towards the recipient. That hand cannot be used for any other purpose.

This spell is not a charm effect and cannot be resisted with the racial ability *RESIST CHARM*.

"With mystic force I Repel you."

Restore Limbs



Thorna's Entropy Disrupter

Level: 7 **Duration:** Instant

This spell causes all of the target's *Withered* limbs to become usable and restored.

"I call upon the earth to Restore your Limbs."

Sanctuary



Hector's Aura of Protection

Level: 4 **Duration:** Indefinite

This spell will remain in effect as long as the subject's hands are clasped overhead and they do not receive any body damage. The recipient is protected against all non-ranged attacks from undead creatures. Ranged attacks (such as spells, missile weapons, and gas globes) can affect the recipient.

If you are unsure if an attacker is undead or not, you will be affected by them. You may not call a Hold or otherwise go out of game to ascertain their status.

The character with a *SANCTUARY* active may use no game abilities except touch-casting on themselves. Attempting to pick up an item will disrupt the spell.

"I call upon the earth to grant you Sanctuary."

Shatter



Zalinarik's Shattering Force

Level: 3 **Duration:** Instant

This spell may be cast upon any weapon or shield or any item up to a shield in size. It may also be cast at a creature, to affect such an item. This spell will not shatter a shield-like hole in something larger than a shield, nor will it have any effect on armor.

The item affected is rendered completely useless. This spell will not work on an unshatterable item or a magically protected item. Shattering an item that has other items within or fastened to it will destroy all of the items. This spell will shatter not only a shield but also any scrolls attached to the back. Shattering a box or door will set off any traps present as well as the items within.

After the item is shattered the prop for the item remains, but is unusable.

"I summon a force to Shatter <item>."

Shield



Almrood's Protective Field

Level: 1 **Duration:** Indefinite

This spell gives the recipient five extra Armor Points. These extra points are the first Armor Points lost due to damage.

*"With eldritch force
I grant you a Shield 5."*

Shield Magic



Tyler's Improved Protection From Enchantment

Level: 5 **Duration:** Indefinite

This spell will cancel the next spell cast at the recipient, including beneficial spells, after which it is used up. You must say "Shield Magic" immediately when this spell is used. Shield Magic will only work on spells delivered via packet, Glyph (See the Formal Magic section for more details), or Spell Strike. SHIELD MAGIC cannot be used in conjunction with a REFLECT MAGIC. If you have a SHIELD MAGIC active, you may still "accept" spells that are touch-cast. You

cannot "accept" thrown spells. See "Spell Disruption" on page 46 for more details.

"I call forth mystic power to Shield Magic."

Shun



Jondar's Charm of Avoidance

Level: 4 **Duration:** 5 Minutes

This spell causes the victim to feel great discomfort around the caster. The victim will not attack the caster, and will immediately move at least 10 feet away from the caster and stay at least that far away while the spell is in effect. If the victim is within the 10 feet when the spell is cast, the victim must move away, but never in a manner that will endanger the victim or cause direct harm to them. In other words, they cannot be made to jump off a cliff or walk towards a magical rift or do any other action which would cause harm (much like a Charm spell cannot force the victim to take self-destructive actions). This spell does not create a 10 foot magical circle around the caster which is effective only upon the victim; if the victim has to come closer than ten feet in order to get away (say for example, to pass close to the caster in order to get to an exit), then that is permissible. While within that 10 foot area however, the victim can take no in-game actions against the caster. If the caster attacks the target, the Shun ends immediately.

This spell is a type of charm and can be resisted with the racial ability RESIST CHARM, and it can be cured with an AWAKEN spell or DISPEL MAGIC spell. Stronger charms such as VAMPIRE CHARM or ENSLAVEMENT will override its effects. See Table 5-6 on page 64

"I command you to Shun me."

Shun Animal



Xavier's Bestial Repulsion

Level: 1 **Duration:** 5 Minutes

This acts as a SHUN spell, but will only affect an ordinary animal.

"I command this animal to Shun me."

Silence



Turing's Mystical Muzzler

Level: 5 **Duration:** 5 Minutes

The victim of this spell cannot talk and cannot cast any spell. The victim must still call out the damage points his or her weapons do if combat ensues while the spell is in effect, as well as any out-of-game "trigger" phrases such as "Reflect Magic" or "Parry." The silence can be removed by either AWAKEN or DISPEL MAGIC. This is not a charm spell and thus it cannot be resisted by those with the RESIST CHARM ability.

"I command you to Silence."

Silver Aura



Nataal's Argent Aura

Level: 5 **Duration:** Indefinite

This spell will allow the recipient to use the weapon type silver against one opponent in the manner of a CRITICAL ATTACK. It will not confer any additional damage. The target may choose to end the effect at any time but cannot reactivate it without using another casting of the spell. The spell may be stacked with two other Blade Effects see Table 5-6 on page 64, but the spells will only work one at a time.

"I grant you the power of a Silver Aura."

Sleep



Folson's Somnolent Vapors

Level: 6 **Duration:** 5 Minutes

SLEEP causes the target to instantly fall into a deep sleep. The target will not awaken for 5 minutes unless someone shakes them vigorously while shouting for them to wake. It takes one minute of shaking and shouting to wake a person this way. An AWAKEN or DISPEL MAGIC spell will wake the victim immediately. This spell will not work on some creatures without a metabolism, such as undead creatures, golems, or some giant insects. It can be resisted by creatures with a RESIST SLEEP ability.

"I command you to Sleep."



Stabalize



Vendar's Saving Touch

Level: 1 **Duration:** Continuous

When cast the target of this spell is stabilized as if the *FIRST AID* skill had been successfully used upon them. For this to work the target must have been able to be affected by the skill *FIRST AID*. The caster may continue to perform the verse without actually casting the spell on a target each time the verse is stated without breaking the spell.

"I call upon the earth to Stabilize you."

Stone Bolt



Derros' Disapproving Glare

Level: 5 **Duration:** Instant

This spell deals 25 points of eldritch stone damage to the victim.

"I call forth a Stone Bolt. 25"

Taint Blood



Vorin's Venom Blast

Level: 5 **Duration:** Indefinite

This spell will introduce impurities into the

victim's blood. The victim is left extremely weak, and unable to fight or move faster than normal walking speed. The victim becomes unable to use any game skills.

This spell might not function against creatures with no metabolism. This spell can be removed by a *PURIFY BLOOD* spell or a *DISPEL MAGIC* spell.

"I call upon chaos to Taint your blood."

Tarry



Pale's Dying Denial

Level: 7 **Duration:** 5 Minutes

The target of this spell must be dead and within their five minute death count and able to benefit from a *LIFE* spell. The target will have their death count extended by five minutes. This spell can be cast on a target multiple times but they must have five minutes or less left on their death count or it will not work and the spell will be lost. *TARRY* cannot extend a death count past the time of reset and if it has already extended the count past the initial five minutes when reset occurs the effect will end and the character will go to resurrect. This spell can never be used to allow the target to receive a *LIFE* spell gained in the next reset period if the initial death count expired during the previous reset period. It can never be used to force a character to take multiple castings of the obliterate

formal. At any point past the initial five minute death count the target may chose to end their count and resurrect immediately, a spirit may not be held for longer than their initial five minutes using a *TARRY* against their will even if enslaved or controlled in any other manner.

"I grant you the gift of Tarrying."

Trap Undead



Morien's Malignance Magnet

Level: 1 **Duration:** Line of Sight

This spell will act upon a lesser undead as a *PIN* spell, but the undead may not rip free. This spell will not affect a living target, although it will remove a living person's *SHIELD MAGIC* or *REFLECT MAGIC*.

"I call upon the earth to Trap Undead."

Turn Undead



Yivik's Lesser Sphere of Banishment

Level: 2 **Duration:** 5 Minutes

This spell will affect lesser undead creatures, causing them to leave the area of combat immediately by attempting to break Line of Sight. A *DISPEL MAGIC* or *FREE UNDEAD* will rid the creature of this spell, allowing it to return. Greater undead are not affected by this spell in the same manner. This spell will not affect a living target, although it will remove any creature's *SHIELD MAGIC* or *REFLECT MAGIC*.

"I call upon the earth to Turn Undead."

Unparalyze



Nyrina's Nerve Restorer

Level: 8 **Duration:** Instant

This spell will free the subject from all paralyzing effects.

"I rid you of Paralysis."

Ward



Elenaro's Astral Displacement

Level: 9 **Duration:** 5 Days

This spell magically seals a single room or an entire building. The object affected must be an actual unmovable structure such as a building, a tent, or an unmovable wagon.

No effect, person or object may pass through the Ward unless as described below.

Anyone within the *WARD* during the entire casting of the spell will receive an Investiture to the *WARD*. The names of the people Invested must be written in the room's marshal notes.

Investiture in a *WARD* allows you to enter and leave the warded area at will as well as allow others to enter and leave by saying "*The Ward recognizes you*", and otherwise follows the rules for *EXTENDED CIRCLES OF POWER* described on page 50.

The building must be visibly marked to indicate the presence of *WARD* by placing a large "W" on the door.

This spell takes five minutes to cast during which time the caster rests his hand upon the primary portal. Anyone inside a structure that is being warded will be aware of the casting and will be awoken by it if normally sleeping. This spell can

not be thrown. Ward is not be affected by Dispel Magic.

*"With eldritch force I build a Ward
...Ward Up"*

Weakness



Tyr's Damage Reducer

Level: 3 **Duration:** Indefinite

This spell will curse the victim to do 5 points less damage with every swing (minimum damage being zero, of course).

This spell does not actually reduce a creature's strength. It affects all weapon damage in the same way, whether the weapon is used with one hand or two hands. This spell lasts until removed with a *REMOVE WEAKNESS* or a *DISPEL MAGIC*.

Multiple *WEAKNESS* effects do not stack.

"I curse you with Weakness."

Web



Arakin's Eldritch Binding Force

Level: 5 **Duration:** Line of Sight

This spell snares the arms of its victim, binding them straight to its sides, and immobilizes the victim completely from the neck down. The victim may talk freely,

but may not use any game skills requiring use of the arms, including using a weapon or shield, casting a spell, or activating a gas globe.

The victim may not walk,

run, or be moved in any way. Any item the victim is holding cannot be dropped. However, since the effect allows the victim to be searched, anyone else can choose to physically remove a hand-held item from the victim simply by "*searching*" them. Even a victim with Superhuman Strength cannot prevent himself from being "*searched*" in this manner. This spell does not prevent the victim from being searched or being given a Killing Blow.

"With mystic force I Web you."

Wither Limb



Thorn's Accelerated Entropy

Level: 7 **Duration:** Indefinite

This spell causes the target's limb to become aged and infirm. The limb may be specified by the caster (right or left leg or arm). You can have up to four *WITHER LIMB* spells upon you at a time. No weapon may be wielded by that limb nor may the limb be used for locomotion or spell casting. If a leg is withered you must kneel down (unless you can't due to a medical reason), you may not hop on the remaining leg. Only an arm or leg can be thus withered. Tentacles or similar appendages are considered arms for this purpose. The head, tongue, or any other such organ do not count as limbs. A *DISPEL MAGIC* will remove all active *WITHER LIMB* spells. If the caster does not specify, or if the spell is received from a potion or carrier attack, then it is the target's choice as to which currently un-withered limb becomes withered. If all your limbs are withered, call "got it." See "*Stacked Effects*" on page 47.

*"I call upon chaos to Wither your
<Limb>."*

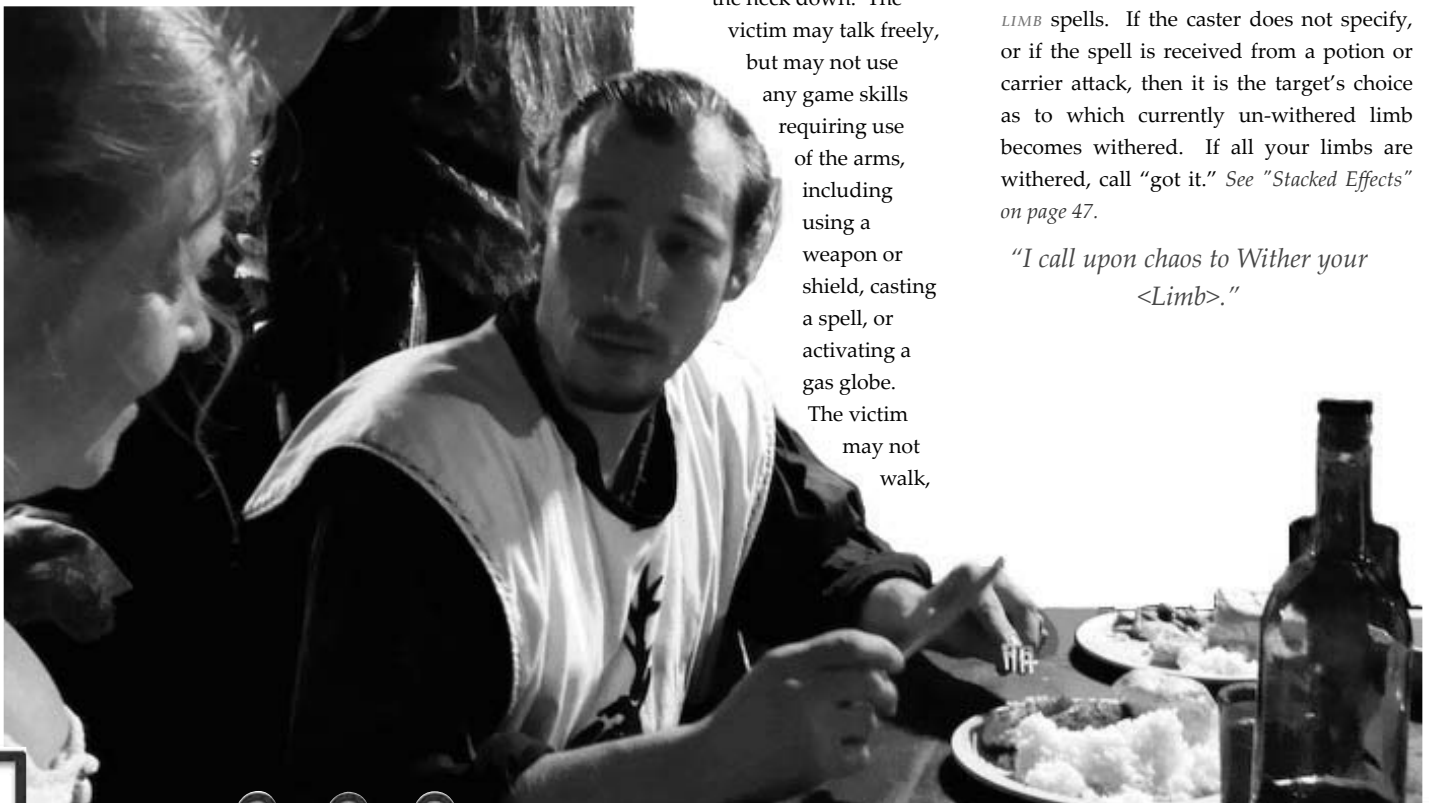

game play



Combat



afety is NERO's main concern. These rules are designed to give players the feel of medieval combat without the pain and suffering of the real thing.

is sneaking up on you. Please play fair and try not to gather information while the Hold is being sorted out. When the reason the Hold was called is resolved, then the person calling the hold should call a Lay-on. First, insure that everyone is ready to resume play, then call "3. .2. .1. .Lay-on!"

Hold can also be called for excessive zeal on the part of an opponent. The infraction should be reported to a marshal. Repeated complaints will get a player removed from combat.



The Hold Rule

This is the single most important rule in this entire book. Read it and take it to heart.

Anyone can call a hold in a fight if they see an unsafe situation happening or about to happen. "Hold!" should be yelled so that everyone in battle can hear it—otherwise, it may be followed by another flurry of swings. When a Hold is called,

1. Stay exactly where you are
2. Drop to one knee (unless you can't due to a medical reason)
3. Do Not Move.

Do not look around you or talk to people about anything not connected with the Hold. You can use this time to update your tags and remove any spells that you have cast. You can also pick up spell packets from the ground or from your pouch as long as you return to your original spot before the game is resumed.

This is not a time to study someone and see if they are an NPC or a PC, nor is it a chance to look behind you and see if anyone

Hold can also be called if anyone's eyeglasses are knocked off.

You cannot call a Hold to collect spell packets even though they are out-of-game. You may pick up packets during a Hold that has been called for another reason.

Collecting tags or treasure is not a legitimate reason for calling a Hold. Tag bookkeeping should be done after the battle is over, not during it.

Anyone who ignores a Hold called for any reason will face severe disciplinary action and possible expulsion. This is usually used for emergencies and not to be treated lightly. Stop what you are doing immediately and find out why a Hold was called, then do what you can to help. You must return to your original spot before the Lay-on is called.

If you see a crowd of people kneeling down, then they are probably in a Hold. Do not approach the group until the Hold is over.

If you are in the middle of a battle and everyone starts dropping to one knee, then a Hold has probably been called and you did not hear it.

Counted Actions

Some actions cannot actually be performed for reasons of safety or reality, but must be considered as taking some time to complete. Such actions will have a specific count, usually three, and a definite phrase to indicate what is happening.

For example, to simulate a zombie rising from the ground, the NPC playing the zombie could say *"I climb out of the ground one, I climb out of the ground two, I climb out of the ground three."* During the time in which the player is saying this, he or she is completely vulnerable to attack and cannot use any game abilities except *DODGE*, *PHASE*, *RETURN* and *RESIST*. These abilities cause the counted action to be interrupted. The skill is used up, and the count is aborted and must be started again.

A counted action such as breaking a binding effect (using *"Rip From ..."*), performing a Killing Blow, or going Gaseous requires the same number of seconds as the number of the count, or the duration of the count, whichever is the longest. This means that a Killing Blow requires at least 3 seconds to perform, no matter how fast the player says *"Killing Blow 1, Killing Blow 2, Killing Blow 3"*. In the case of simultaneous, identical length counts, who ever started the count first *"wins"* it does not matter how fast you say it. Spell defenses such as *SHIELD MAGIC* do not interrupt a counted action.

For example, Cerik the vampire is turning gaseous. During the three count, he is hit with a Cure Light Wounds spell. He takes the damage from the spell but it is not enough to destroy him, so he can continue his three count.

Example two: Cerik gets hit with a Destroy Undead spell. This would destroy him, so he uses his Phase skill. The use of that skill has interrupted his three count, so the Gaseous Form skill has been used up, and unless he has that skill twice, he cannot attempt it again.

Before performing a counted action, NPCs will often take their places while wearing a white headband. Players who see this can have their characters experience an *"eerie feeling"* that something is amiss. This is not an excuse to metagame as to exactly what will happen, but role-playing caution is acceptable.

This is not a way to invent your own abilities. All such actions are defined by NERO. Counted Actions are not appropriate for actions you can actually perform safely and within the rules.

Body Contact

The only contact allowed during battle is by weapon. Any other type of fighting contact such as grabbing someone, hitting, or

kicking is strictly forbidden. Violation of this rule is the shortest path to disciplinary action.

Pinning and Trapping Weapons

Although *"pinning"* weapons is a mainstay of many swashbuckling movies, many of the moves used to free yourself from a weapon pinning are dangerous and as such not allowed in NERO combat. As a result, the following restrictions have been placed on *"pinning"* or *"trapping"* weapons:

Trapping

Any weapon shaped in such a way as to trap weapons (whether accidentally, or by design) is expressly forbidden.

"Trapping" occurs when one weapon is used to hold another weapon so that it becomes useless. A weapon with multiple tines for instance can be used to grab and twist the opponent's blade, thus *"trapping"* it.

Any weapon that is reported as trapping weapons will not be allowed in game. A marshal has the right to reject any weapon for this reason.

Pinning

"Pinning" occurs when one weapon is used to apply force on an opponent's weapon, capturing the weapon by holding it against a wall or a tree or other stationary object.

Pinning of weapons can only be done with another weapon, and only outdoors. Indoors, the limitations of the situation lead to an unnecessary chance of injury. If your weapon is pinned, you may pull the weapon straight back to free it. If the weapon is shaped in such a way that it is not possible to pull it out, then you're stuck—the weapon is pinned and there's nothing you can do about it. You can back up to try to free yourself and your weapon, but shoving your opponent or charging are not allowed.

Charging

During NERO combat you must never come into physical contact with your opponent. It is the responsibility

of all parties involved in combat to ensure that there is always a safe distance between combatants. If you are crowding your opponent so much that he or she must step back to avoid body contact with you, you are Charging. No combatant should be able to touch the torso of an opponent in combat. If you can reach out and touch the torso of an opponent, then you are too close. Any combatant who has moved too close must increase the distance to be greater than his or her arm length, though at no time may someone shove away an opponent or otherwise initiate physical contact. In the case of extreme differences in arm length, the combatant with the shorter arm length is allowed to approach close enough to strike their



opponent so long as they cannot touch the opponent's torso with their own hand.

Legal Targets

Legal targets include the entire body except the head, neck, throat, hands from the wrist out, and the groin. A player observed to be hitting restricted areas repeatedly is subject to disciplinary action.

You may not intentionally block a hit with an illegal target.

Blocked and deflected shots do not count. This is admittedly a judgment call. If the block was good, then the weapon just grazed an arm or leg and the shot does not count. If the block was weak and the swing hit with about half or more normal force then the hit should count.

Unskilled Weapon Use

If you do not have the skill to use a weapon you are carrying, or if you are presently unable to use a weapon in which you are skilled, such as wielding a two handed weapon with one hand you must either immediately drop the weapon or take any damage that hits your weapon as if you had been hit.

Swinging your weapon

The NERO combat system is an honor system. Each player trusts that the person whom he is hitting is correctly counting his or her hits. *"But I'm an evil thief."* You still have to count your hits. The NERO combat system relies on all players being honest in real life even if their character is a nefarious liar. Remember, even the NPCs are there to have fun, albeit by dying in a good clean fight.

NERO is a fantasy game with a fantasy combat style. The normal rules of armed combat don't apply as they are geared toward doing all the things we strive to prevent, i.e. injure your opponent. So because of this some compromises must be made in realism.

Baseball Swing:

One thing you must remember: you are only trying to make contact, not hit a home run. Do not reach back, wind up, and take a huge swing at your opponent.

It is usually not necessary to hit hard at all. When fighting an unarmored and unarmed opponent, an easy tap will do. You only need to apply enough pressure to make sure your opponent is aware of the attack.

For example, hitting an armored opponent from behind by surprise might require more vigor than a standard tap. And if it seems that your opponent is not taking his or her hits, it might be because the hits are not being felt under all that armor. You should mention to your

opponent when you think you got a hit in, and all players should call hits whenever possible.

Machine Gunning

If you are swinging so fast that you cannot announce the damage fast enough to keep up with the swings, then you are *"Drum Rolling"* or *"Machine Gunning"* and your opponent should count all of that as one or maybe two hits.

A good rule of thumb is to have your swing progress between 45 and 90 degrees. Most importantly swings must be controlled and must not hit too hard.

Shields

Shields cannot be used as offensive weapons. Shields are strictly for defense.

Shields do not protect the owner from any kind of trap other than a weapon trap, which uses a weapon blade or missile weapon to deliver its damage.

Shield Bashing

Shield Bashing is the intentional use of a shield to gain physical out-of-game advantage over an opponent. Shield Bashing is a serious violation of NERO safety rules—it is similar to Charging. The potential for injury is great. Excessive use of Shield Bashing will result in warnings and possible loss of the Shield skill.

Shields cannot be used with two handed weapons. You may not wield a weapon with the hand or arm holding the shield.

Also your shield arm may not have any other items or weapons attached to it. Tucking a dagger behind your shield arm would negate your ability to use the shield.

Spell Grounding

Any item you throw, toss, or let go of is still considered to be in your possession until it lands and comes to a complete rest. Any attack that hit such an item before it lands and comes to rest will affect its possessor. If the attack targets the thrown/dropped item directly, such as *SHATTER* or *DESTROY*, the item is still affected.

Bucklers

A "buckler" shield (a small shield that is strapped onto the arm) must still follow all shield rules. In other words, you cannot have a buckler on your left arm and still hold anything in your left hand.

Turtling

"Turtling" or hiding behind an impenetrable shield (with little more than your head showing) is not allowed! Anyone using a shield in such a manner could be subject to warnings from the marshals and if necessary, loss of the shield skill. Shields in our game are not all that realistic, and as such you are artificially limited in what you can do with them.



In real life you could overbear someone who was hiding behind a shield, but such contact is not allowed in our game. If you are short and using a maximum sized shield that prevents any legal targets from showing then you are Turtling.

Delivery Methods

There are a few different ways for damage or effects to be dealt in the game. The following are methods in the game to use effects or deal/cure damage: Packet, Weapon, Ingested, Contact, Touch, Area of Effect, and Vengeance.

Contact

Contacts are effects delivered instantly through touch. With contact effects you can call defenses.

Ingested

These effects must be ingested to gain the effect. Ingested effects bypass protectives like Shield Magic and Poison Shield.

Packet

All packet-delivered attacks are effective on contact with the target or any of the target's immediate possessions, such as a shield or cloak. Arrows are not considered packet attacks.

Packet attacks include spells, gas globes, and certain monster abilities. Note that unlike the weapon rules, a packet attack will count if it hits "non-legal targets" such as the head or groin but that's not to say you should aim at these illegal targets.

Touch

An effect delivered through touch does not effect any defenses, instead the target of the touch, can choose to "accept" the effect or state "I do not accept", at the time the effect is delivered.

"Touch-Casting" on page 46 for more information.

Vengeance

A vengeance is an effect that has a unique delivery method. It automatically targets whoever deals a killing blow to the owner of the Vengeance for more information on vengeance see the *NERO Formal Magic Rules*.

Weapon Blow

Weapon blows are dealt with nero safe hand held boffers, and thrown boffers. Arrows are also considered weapon blows even though they are phys-repped by yellow packets.

Effects Types

In addition to delivery methods, there are also effect types which change what protects you from the damage or effect. Once you take the effect, it is the same no matter what the effect type.

Arcane: Effects delivered this way are created from raw magical energies. They are not blocked by regular spell defenses. The same casting rules apply as spells except you do not need the ability to speak.

Magic: Magic Deliverance is a non verbal way of casting spells. The same casting rules apply as spells except you do not need the ability to speak.

Elemental: Effects and damage delivered elementally are created from elemental energy rather than a spell, so must be blocked by an *ELEMENTAL SHIELD*. Elemental effects can be removed by *DISPEL MAGIC*.

Physical: Physical attacks represent an actual physical force such as a glob of ooze to form a Physical *WEB*, a big rock to form a Physical *STONE BOLT*, or a burst of wind to cause a Physical *REPEL*.

Poison: Effects delivered as poison are stopped by *POISON SHIELDS*. They represent a monster with poisoned claws, fangs, or spittle.

Spell: Effects delivered as spell are blocked by a *SHIELD MAGIC*.

Calling Weapon Damage

When you swing a weapon in NERO, you must call out a verbal that indicates the attributes of the attack. The verbal will have up to four parts, with the first two always present and the latter two only used in special circumstances. The parts are, in order,

<damage amount> <weapon type> <damage type> <effect>.

Figure 6-1.

protective hierarchy

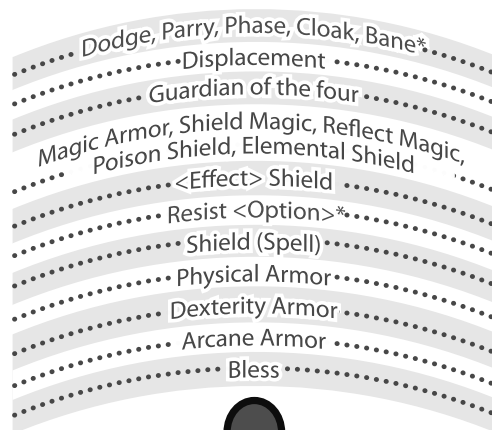

Defenses with () are by choice, the rest are by the next appropriate effect/attack

When in combat with the same opponent, there is no need to continue calling your damage beyond the first or second swing. Weapon verbals are out of game and can thus be made while under the effects of a Silence or Gypsy Curse, however anyone who hears them will know what it is.

Damage Amount

The damage you are dealing with each swing as a numerical value.

Weapon Type

A Weapon's Type determines the nature of the weapon. There are four weapon types: Normal, Silver, Magic, and Massive.

Damage Type

Some creatures may take an increased or decreased amount of damage from certain damage types. The valid Damage Types are variable and up to the local plot team or as granted by effects within these rules so long as the call does not duplicate a game effect.

The most common damage types are the

thirteen core elements (fire, water, order, chaos, etc.) and the Effect Types listed above. The only Effect Types which may not be used as a Damage Type are "Magic" or "Spell." To specify a Carrier Attack as a magical effect, you must use the "Arcane" Effect Type.

Effect: Effects will cause the struck character to take the stated game effect if the attack does damage to Body Points. This is known as a carrier attack. The effect name is used in a carrier attack. Examples of effects include Paralyze, Death, Drain, Obliterate, etc. Some effects also have an option, for example with a Shatter spell you **must** choose the item to be shattered. With a carrier attack this is optional. If the option is unspecified the creature hit by the carrier can choose any valid target that can be affected by the carrier. If none exists you only take the damage. As shown in Table 6-1, the type for all carrier attacks is Physical, unless an additional Effect Type is designated as the <damage type> portion of the weapon call.

Examples

- Example one: If you have a normal longsword, the skill one handed edge, and no other skills, you will do 2 points of normal damage and call out "2 Normal."
- Example two: If you have a special longsword that add +1 to your

damage call and allows you to call for "Magic" then your damage call would be "3 Magic"

Example three: If you have a normal longsword and use up an elemental blade spell (Ice) on your next swing, then your damage call would be "7 Normal Ice"

Example four: A monster attacks with its weaponry that will infect your blood with a magical taint that causes debilitating effects. Its damage call is "10 Magic Taint Blood." You have only 5 Armor Points and 10 Body Points when the weapon strikes your chest. Because your Body Points take damage, you are now under the effect of a Taint Blood spell and have only 5 Body Points remaining.

Example five: A monster attacks you with its sword and hits your leg, calling "5 silver fire death". You have 10 Armor Points, which are now reduced to 5, but are not subject to the Death effect because the attack failed to damage your Body Points.

Example 6: A monster attacks you with it's claws and hits you on your arm, calling "5 Normal Shatter Sword" you are not wearing any armor, so you take the effect, you are holding a sword in each hand, one of the swords is rendered and therefore cannot be affected by the carrier, so your other sword takes the effect, it has 2 shatter resists still unused, you call resist and take no damage. Your sword now has 1 shatter resist.

Delivery Methods Table 6-1.

DELIVERY TYPES		EFFECT TYPE	BOFFER	ARMOR	MAGIC ARMOR	SHIELD / REFLECT MAGIC	ELEMENTAL SHIELD	POISON SHIELD	PARRY	DODGE	DISPLACEMENT & PHASE	RESIST & EFFECT SHIELD	CLOAK & BANE
WEAPON BLOW	Normal, Silver	Physical	✓	✓	✓			✓	✓	✓			
	Magic	Physical	✓	✓	✓			✓	✓	✓			
	Elemental	Physical	✓	✓	✓			✓	✓	✓	✓	✓	✓
	Massive	Physical		✓	✓			✓	✓	✓			
	Physical Strike	Physical			✓			✓	✓	✓	✓	✓	✓
	Carrier Attack	Physical	✓	✓	✓			✓	✓	✓	✓	✓	✓
	Spell Strike	Spell				✓			✓	✓	✓	✓	✓
	Weapon Trap	Physical	✓	✓	✓			✓	✓	✓			
PACKET	Spell	Spell				✓			✓	✓	✓	✓	✓
	Elemental	Elemental					✓		✓	✓	✓	✓	✓
	Physical	Physical			✓			✓	✓	✓	✓	✓	✓
	Magic (Effect)	Spell				✓			✓	✓	✓	✓	✓
	Arcane	Spell							✓	✓	✓	✓	✓
	Poison	Poison						✓	✓	✓	✓	✓	✓
	Gas Globe	Poison						✓	✓	✓	✓	✓	✓
AREA OF EFFECT	Acid/Flame			✓							✓		
	Poison	Poison						✓			✓		
	Explosive			✓									
	Massive Mechanical	Physical		✓									
Ingested & Contact	Contact Poison	Poison						✓			✓	✓	
	Elixir	Poison						✓			✓	✓	
	Potion	Spell									✓	✓	
Vengeance	Vengeance		✓										

Conversational Combat

All non-ranged attacks must be delivered in a clear, conversational tone of voice (no yelling). Further, once you have announced your damage to your opponent, there is no need to continue announcing it until another opponent appears. This is in addition to existing rules for damage, and does not supersede them in any way.

Negating Attacks

If any part of an attack is negated, then the whole attack is successfully defended against and will not take effect. For example, an Elf who uses *RESIST SLEEP* against a Monster who calls "10 Normal Sleep" in an attack that would ordinarily do body damage will neither be affected by Sleep or take damage.

While you cannot stack effects, being hit by a carrier while you are already under the effect does not make you immune to the damage. So if you are under the effect of sleep and hit with "10 sleep" you still take the damage.

This negations applies only to the creature or character, not items in it's possession. Therefore an elf with rendered armor and a rendered weapon, does not negate damage from the call "10 Normal Shatter."

Calling Hits

Calling hits against yourself is strongly encouraged by role-playing being struck. Acknowledging which hits you are accepting and which ones you feel you blocked will help the flow of combat.

Throwing/Tossing Items

You cannot throw any weapon, shield, etc., that is not NERO approved for throwing. Basically, if a local safety marshal has approved the weapon to be thrown (thrown weapons, javelins, etc.), you can throw it, otherwise you cannot.

In addition, you cannot use the "toss and grab" method on any item to avoid the effects of a spell. If you toss an item and grab it before it lands on the ground, the item is still under your control, and is still considered in your possession.

For the purposes of spells that target the item itself (such as Shatter), an item is still considered under a player's control until it comes to a complete rest on the ground out of the player's grasp

Special Abilities

There are many creatures in the NERO world that have special abilities or powers. The effects of these are described below.

Delivery Methods			Table 6-2.
	DELIVERY TYPES	TAGLINE	EXAMPLE
WEAPON BLOW	Normal, Silver	<Damage amount> <Weapon type> <Damage type> <Effect>	"10 Normal"
	Magic	<Damage amount> <Weapon type> <Damage type> <Effect>	"6 Magic"
	Elemental	<Damage amount> <Weapon type> <Damage type> <Effect>	"8 Normal Lightning"
	Massive	<Damage amount> <Weapon type> <Damage type> <Effect>	"3 Massive"
	Physical Strike	"Physical Strike" <Effect>	"Physical Strike Sleep"
	Carrier Attack	<Damage amount> <Weapon type> <Damage type> <Effect>	"12 Normal Ice Paralyze"
	Spell Strike	"Spellstrike" <Effect>	"Spellstrike Wither Limb"
	Weapon Trap	<Damage amount> <Weapon type> <Damage type> <Effect>	"8 Normal"
PACKET	Spell	<Spell Incant>	"I call forth a Stonebolt 25"
	Elemental	Effect: "Elemental" <Effect> Damage: <Damage amount> "Elemental" <Damage type>	"Elemental Sleep" "10 Elemental Flame"
	Physical	Physical <Effect>	"Physical Bind"
	Magic (Effect)	Magic <Effect>	"Magic Death"
	Arcane	Arcane <Effect>	"Arcane Paralyze"
	Poison	Poison <Effect>	"Poison Wither Limb"
	Gas Globe	<Effect> Gas Poison	"Nausea Gas Poison"
AREA OF EFFECT	Acid/Flame	"5 ft Radius" <Damage amount> <Trap>	"5 ft Radius 30 point Acid Trap"
	Poison	"5 ft Radius" <Effect>	"5 ft Radius Cause Wounds 10"
	Explosive	"5 ft Radius" < Damage amount > "Explosive Trap"	"5 ft Radius 20 point Explosive Trap"
	Massive Mechanical	<Damage amount> "Massive"	"10 Massive"
Ingested & Contact	Contact Poison	<Effect> "Contact Poison"	"Cause Disease Contact Poison"
	Elixir	<Effect> "Elixir"	"Cure Light Wounds 5 Elixir"
	Potion	<Effect> "Potion"	"Awaken Potion"
	Vengeance	<Damage amount> Arcane Vengeance	"100 point Arcane Vengeance"

Some monsters are represented by multiple NPCs. These are either organisms that can divide into many segments, or are larger than man sized. In some cases, these creatures will be affected differently by battle magic spells. The spell may only affect one of the creature's segments. A spell such as Pin may only affect the segment it hits, allowing the creature to pivot around the affected part. Once again, the monster should have documentation describing any special allowances it may have.

Occasionally, a monster's abilities may change from event to event or even during an event! This can be the result of many things, from mutation to strange magics to a new tribe moving into the area.

Packet Attacks

Packet attacks follow the same basic rules as any other skill involving a packet, the user must say out loud in a clear voice the "verbal" then they may throw the packet. All attacks that duplicate a spell or effect that contains a number must include that number at the end of the verbal (ex. A monster hurls a Physical CAUSE WOUNDS packet, the correct verbal before throwing is "Physical Cause Wounds 10").

These attacks represent monsters' abilities to generate ranged attacks such as poisonous spittle, breathing fire, or charming you with their will. There are only 5 different delivery types for packet attacks; Arcane, Elemental, Magic, Physical, and Poison. The delivery type determines what delivery type specific spell defense(s) can be used. The effect itself would be cured by whatever is listed in its description, by any other effect whose description allows it to cure the effect (ex. AWAKEN's description specifically allows it to cure SLEEP), or from the list below. Limitations on curing in the description still also apply if the description says the effect can only be cured by specific effects or cannot be cured by specific effects. None of these attacks may use orange or yellow packets as orange packets as orange are used to physically represent gas globes and yellow packets are arrows. A creature must have use of its arms and may not be holding any other in-game object in its hand in order to use a packet attack, even if it is touch-casting the ability. This includes claws, which must be retracted in order to use any packet-based ability.

Arcane <spell name or effect>

Effects delivered as arcane will ignore and not expend a SHIELD MAGIC or REFLECT MAGIC spell. These effects are removed by a DISPEL MAGIC.

Elemental <spell name or effect>

Effects delivered as elemental will be stopped by an ELEMENTAL SHIELD. Elemental attacks may also be delivered as damage in which case a number will be stated before the word "Elemental" and will be followed by the damage type that the damage is attributed to. Please see "Weapon Blow" on page 87. These effects are removed by a DISPEL MAGIC.

Magic <spell name or effect>

Effects delivered as magic will be stopped by a SHIELD MAGIC spell or a REFLECT MAGIC spell. These effects are removed by a DISPEL MAGIC.

Physical <spell name or effect>

Effects delivered as physical will be stopped by a MAGIC ARMOR spell and can be stopped by a PARRY. These effects are removed by a REMOVE PHYSICAL.

Poison <spell name or effect>

Effects delivered as poison will be stopped by a POISON SHIELD spell or the racial skill RESIST POISON. These effects are removed by a PURIFY BLOOD.

Additional Effects and Attacks

Base Claws/Body Weaponry

Monsters with this ability can strike with large claws or fists. The phys-reps will always be covered in red duct or kite tape; however, you cannot tell the difference between claws and real weapons unless you can actually see the red tape. The claws cannot be Fumbled, Shattered, or Destroyed. The NPC cannot call a Hold to pull out claws. Consider the claws retractable.

Control Undead

Some undead creatures can control other less powerful undead in the area, making them do whatever they want. This effect is stronger than CALM/CALM ANIMAL CHARM/ CHARM ANIMAL, SHUN/ SHUN ANIMAL, or FEAR. The most recent CONTROL UNDEAD, VAMPIRE CHARM or ENSLAVEMENT effect will take precedent if there is a conflict See "Table 5-6."

Curse of Transformation

Some monsters (notably werewolves and vampires) have the ability to curse their victims so that they will turn into versions of themselves under appropriate circumstances. Werewolves can turn their victims into werewolves who will then change on the next full moon (and every full moon thereafter). Vampires can turn their victims into lesser vampires. These curses cannot be resisted as per spirit targeting formal rules. The character is usually not dead when they are afflicted with a Curse of Transformation. Once Cursed, when the appropriate circumstances are met,



the character will transform into a lesser form of the master who Cursed the character. All life and death rules are still in effect - the player will enter her death count when she is reduced to -1 body points, she will have 5 minutes to receive a *LIFE* spell, though the *LIFE* spell may or may not cure the "Curse". You will always receive a card that states the additional abilities of your curse that you will then carry with your character card at all times.

Drain

This attack causes the victim to be unable to use any in game skills and may not run. *DRAIN* will last for 5 minutes or it can be removed with a *LIFE* or *REMOVE DRAIN* spell. This effect is not affected by a *DISPEL MAGIC*.

Drain Life

This attack is the same as *DRAIN* but lasts until a *LIFE* spell is given or the victim resurrects. It cannot be removed by a *DISPEL MAGIC* or *REMOVE DRAIN*.

Fear

Some creatures have the ability to invoke a magical fear. The racial ability *RESIST CHARM* can be used as a defense against this ability and an *AWAKEN* or *REMOVE FEAR* spell will free someone who is Feared. The feared victim must attempt to break Line of Sight and cannot attack the creature they fear in any way. If breaking Line of Sight is impossible, the victim will stay as far from the attacker as possible. Even if Line of Sight is broken the effect lasts for five minutes or until the creature is dead.

For example, Drina gets Feared by a vampire. She runs screaming around a corner and ten seconds later (as per the "Line of Sight" rule), she feels calm again. If the vampire then appears around the corner, Drina must run screaming again, as the five minutes are not up. The victim cannot cast an AWAKEN spell on himself or herself until out of Line of Sight.

Infection

Some creatures have the ability to infect helpless victims with material that will turn the person into a version of the creature. Unlike a werewolf or vampire curse, this is only a physical transformation of the victim's body. Players will be told of specific triggers if necessary. Victims will lose all memory of their former lives, and the player must follow the commands they are given by the Monster Master until the character is slain.

The character may then be killed and then given a *LIFE* spell and be cured

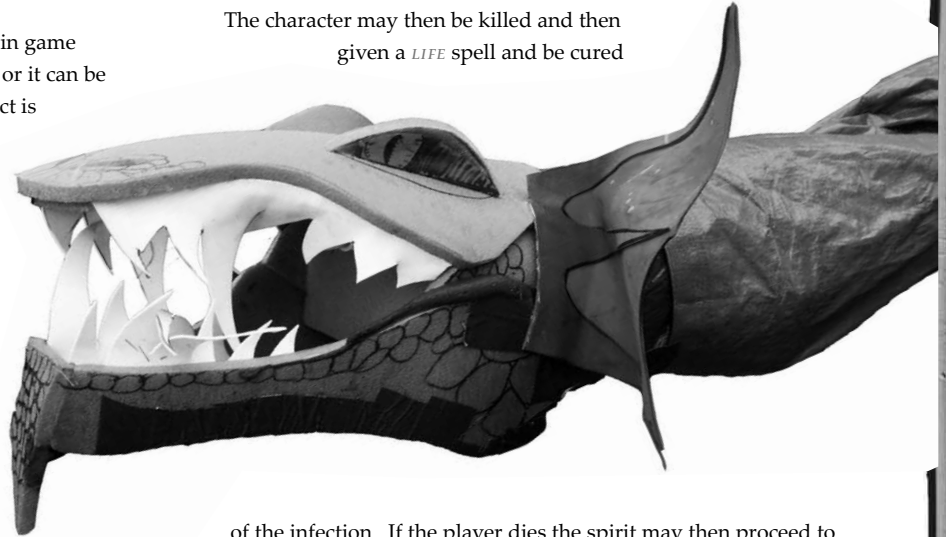

of the infection. If the player dies the spirit may then proceed to the Healers' Guild to be resurrected as normal. Infection is done just as a Killing Blow, with a count of "I infect you 1, I infect you 2, I infect you 3."

Lesser

Some NPCs will be able to deliver "Lesser" versions of attacks. The word "Lesser" is used as the first word in a verbal and indicates that the following effect will only last 10 seconds if it normally has a duration greater than instant. If the duration is instant then Lesser is meaningless. For example, a ghoul calls "Lesser Poison Paralyze" and throws a packet at Steve. Steve, lacking any defense to prevent it taking effect, is now Paralyzed for 10 seconds.

Massive

Some creatures can use the Massive weapon type. Massive damage cannot be blocked by weapons or shields. If a blow delivering this type of damage strikes a weapon or shield, the bearer of the item struck takes the damage delivered, as well as any carrier effects (when appropriate, i.e. once Body Points are damaged). The skills *PARRY* and *DODGE* will work as normal against this type of damage, as will all applicable protective spells such as *MAGIC ARMOR* or *DISPLACEMENT*.

Physical Strike

This ability functions as Spell Strike but is stopped by a *MAGIC ARMOR* or *PARRY* instead of a *SHIELD MAGIC* or *REFLECT MAGIC*. The proper verbal is "Physical Strike <Effect>".

Spell Strike

A few powerful magical creatures have the ability to generate spell effects in their weapons. The spell effects are just as the spell, except that they are delivered with a weapon strike instead of a spell packet. As with any weapon strike, all weapon safety rules





must be followed. The spells are still subject to spell defenses as a normal spell. This ability does not require Body contact. When this power is used, the player will call “*Spell Strike <Effect>*” and will deliver a NERO-safe hit. The skill can still be used even when silenced, but the effect is recognizable to all who hear it.

The spell portion of a Spellstrike is only stopped by defenses that would stop the attack if it were delivered by packet. Therefore, *MAGIC ARMOR*, although it stops “*the next single strike by a NERO Safe weapon*”, does not stop a Spellstrike. Since a Spellstrike is weapon-delivered, the user must have the in-game skill to wield the weapon in order to use the Spellstrike. For example, if the user is under a game effect that prohibits the use of in-game skills, then they cannot use a Spellstrike. Also, if the Spellstrike is delivered by a non-ranged weapon, then the attack will not affect creatures under the effects of a *SANCTUARY* and *DESECRATE*, as appropriate.

Superhuman Strength

Any creature with superhuman strength can do more damage with any particular weapon than can a normal human. This bonus damage is split in half if the creature is fighting with any weapon other than a two handed one. Note, that creatures with Superhuman Strength can gain only limited advantage from either an *ENDOW* or a *DELAYED ENDOW*. (See the spell descriptions for more details).

Vampire Charm

Vampires can charm a person if they can maintain eye contact for 10 seconds. More powerful Vampires can deliver packet attack *VAMPIRE CHARMS* as well. This power does not require body contact. If you are charmed by a Vampire, then you must obey all commands the Vampire gives you. These commands are absolute and are much more powerful than a *CHARM* spell; if a vampire tells you to commit suicide, you will do so unquestioningly. Spell defenses appropriate to the delivery type can be used to stop a packet-delivered Vampire Charm. The racial skill *RESIST CHARM* will protect the character from this effect. The effect lasts five minutes. This effect is stronger than *CALM/ CALM ANIMAL CHARM/ CHARM ANIMAL, SHUN/ SHUN ANIMAL, or FEAR*. The most recent

CONTROL UNDEAD, VAMPIRE CHARM or ENSLAVEMENT effect will take precedent if there is a conflict. See Table 5-6 on page 64.

Special Defenses and Vulnerabilities

Some creatures have special defenses that protect the creature from attacks, or weaknesses that make it more vulnerable to certain effects.

Damage Cap <X>

This ability allows the creature to limit the amount of damage taken from weapon attacks that would otherwise affect it. The call for a *DAMAGE CAP* is “*Cap x*”, where “*x*” is the amount of damage the creature is taking. *DAMAGE CAP* never affects spells, slays or assassinate.

Double from <damage type or effect>

Some creatures take double damage from certain effects or spells and it is always written on their character documentation. All damage of that type that would normally affect the creature is doubled by the recipient when they are hit.

<Effect> Shield

This monster ability acts just like *RESIST* except that it must be used on the first applicable attack that would affect the creature. This means they can only be used after Spell Defenses like *SHIELD MAGIC* and *REFLECT MAGIC*.

Focus

Creatures with this ability are not subject to Disruption for one or more of their attacks.

Gaseous Form

Creatures that are forced into gaseous form when they are killed drop their possessions. Creatures which voluntarily turn into gaseous form while still “*alive*” can bring their possessions with them. Creatures that turn gaseous will drop any other creatures being carried at that time. While they are in this form they are immune to all attacks except *ARCANE SOLIDIFY*. They may only move at a normal walking rate. They cannot speak or move

objects. Creatures in *GASEOUS FORM* still appear as they normally do. Voluntarily Turning gaseous or solidifying is a three counted action.

Harmed by <damage type or effect>

Some creatures take damage when struck by certain spells or effects.

Heal by <damage type or effect>

Some creatures are healed by certain types of spells or effects (For example, air, earth, fire, water, or all of them). Creatures with this ability cannot be healed by weapon attacks (except Spellstrikes), but can be healed by packet attacks. Creatures healed by a damage type or effect are immune to weapon attacks (except Spellstrikes) using those types or effects.

Immune to/from <damage type or effect>

Many creatures have immunities to some spells or effects. Creatures must call "*No effect*" when using this ability.

Immune to <Type> Weapons

Several types of creatures require special weapons (for example, silver or magic) to damage them. Normal weapons will do no damage, but the special weapon will do full damage. These creatures will tell you "*No effect*" if your damage is not affecting them.

Mind Abilities

Some creatures can perform mental abilities such as "*mind melds*." These abilities are all completely role-playing in nature. Generally speaking, a creature with this ability can instill or remove role-playing insanity or otherwise "*cure*" mental damage. This ability can not be used to tell if another player is telling the truth or to counteract forget-it poisons or otherwise get around any NERO rule. A player always has the right to refuse to role-play any of these skills and can at any time decide to "*break off*" the contact or be cured. In order to use this role-playing skill, the players must be touching each other and be concentrating completely by either staring in each other's eyes or having their eyes closed. You cannot perform any in-game skills while role-playing this.

Natural Armor

Some monsters have a skin that acts like armor. It can be refit in sixty seconds. It cannot be Shattered or Destroyed in any way nor can it be salvaged after the creature is killed.

No Metabolism

Some monsters lack a metabolism. The standard definition is as follows: *IMMUNE TO DEATH, DISEASE, DRAIN, DRAIN LIFE, FIRST AID, LIFE, NAUSEA, PARALYZE, POISONS, SLEEP, TAINT BLOOD, WAYLAY, WITHER LIMB.*

Non-Corporeal Form

Some monsters are non-corporeal, having no physical form but made mainly of magic or energy. While they are in this form they are immune to normal weapons, and are immune to *PIN, BIND, WEB, AND CONFINE.*

Phase

Some creatures can become non-corporeal for an instant, avoiding an attack as the *DODGE* skill, and announcing "*Phase.*" Unlike *DODGE*, *PHASE* can be used even if the creature is completely immobilized, such as in a *CONFINE* or *PARALYZE.*

Reduced Damage

Some monsters take less than normal damage from certain attacks. The NPC must call "*reduced*" when using this ability.

Regeneration

Some creatures can regenerate Body Points by spending time to regenerate, much like refitting armor. The time it takes to regenerate is most often one minute but this may vary from creature to creature. If the regeneration time is interrupted by a weapon blow or a spell that affects the creature, the process must begin again. If the process is completed, then the creature regains all lost Body Points. Some creature can do this at zero body, in this case nothing interrupts the regeneration except a killing blow that affects the creature.

Renew <option>

This ability allows a creature to renew one or more abilities or skills that have limited uses by fulfilling some condition defined by that creature's abilities. The most common condition is to take a minute to reset the ability in a manner similar to resetting armor, where any interruption prevents the abilities from returning. Some creatures may also renew skills when entering an area or even if they use another power like *REVIVE.* The options for this ability are



a “single skill” chosen by the target, a “<specific skill>” chosen by the creature using the *RENEW* ability, or “all” skills and abilities.

Resist <effect>

This ability is similar to an Immunity except that it is for a limited number of times per day. Unlike an <Effect> Shield, the creature with this skill can decide when to use it.

Return <type>

A creature with the ability to Return <type> will cause a specific type of effect directed at it to be returned to its point of origin. It functions like the *RESIST* skill in that the creature can choose when to use a *RETURN*. Returned effects are instantly restored to the character’s skill set, although the character will not be able to use the skill again until they Meditate for 1 minute. *RETURN* can only be used on daily or times ever effects such as spells, *CRITICAL SLAYS*, *ASSASSINATES*, etc. *RETURN* can be used against stored spells/effects from formal magic items and/or production items, and in this case the *RETURN* acts like a *RESIST* in that it prevents the effect and the charge is lost. The creature card will specify the types of *RETURN* available to that creature in a similar way to *RESISTS*.

Revive

A creature with this skill can rise back up after five minutes of semi-death. Instead of dissipating and going to resurrect, the creature rises with full Body Points. The creature will either have a limited number of uses of this ability or there will be some special method of preventing the creature from reviving; for example, some creatures can be prevented from using this skill by applying a Killing Blow with a silver blade.

Rift /Gate

Some creatures can open a rift to another plane to allow for entrance or exit or open a Gate to another place. This is a three counted action unless a fully represented gate prop is used. Some of these creatures also have the power to abduct others and force them to rift or gate out against their will.

Rip from Pin/ Bind/Web/Confine

Some creatures can rip free from binding spells. This is a three-count action with the phrase “I rip free one, I rip free two, I rip free three.” While the creature is doing the three-count, it is vulnerable to attack and a Killing Blow begun prior to the Ripping. While ripping free, the creature may not use any skill requiring movement, such as *DODGE*. A creature with the skill *RIP FROM PIN/BIND/WEB/CONFIN*E can only use this skill upon itself, never upon others.

Solidify

This skill forces a gaseous form to become immediately solid. It is packet delivered with the verbal “<delivery type> Solidify.” Note

that the creature may still turn gaseous again.

Suicide Ability

Some creatures have the ability to destroy themselves if they are captured. This ability may be the equivalent of a Killing Blow or it may cause the creature to instantly dissipate and seek resurrection.

Threshold

This allows the creature to take only a single point of damage from any blow equal to or below its Threshold. The creature must call “Threshold” whenever a blow is landed. However, don’t expect to hear the call for every blow. Once you’ve acknowledged the call, the creature is under no obligation to continuously call “Threshold”, unless new players join the fight. These fights sometimes last a long time, so common courtesy on both sides is highly recommended. If you can exceed the limit of the hide, then the creature will take full damage from your blow. A Killing Blow can always go through a *THRESHOLD*. Spell Defenses and suits of armor are affected by all blows, even if the creature wouldn’t normally be affected.

So You Want to Be a Thief?

Stealing an Item

“Stealing an item” refers only to the in-game stealing of in-game items. You must be very careful when attempting to steal anything in-game. You are never allowed to harm or destroy real property (using in-game spells to *SHATTER* or *DESTROY* is fine because you aren’t harming or damaging real property) in order to steal something. You may not pickpocket characters in *NERO*.

There are special rules for each type of in-game item and you are required to know them. If you are caught stealing something incorrectly, then you are cheating—and ignorance of the rules is no excuse!

Game Money, Magic Items, and Jewelry

You are always allowed to take whatever game money you can find in-game. When taking jewelry or an item, always check to make sure there is an item tag with the item phys-rep. If there is an item tag, then the item tag is now yours. You must temporarily take the item’s phys-rep, which should be promptly given to a rules marshal as soon as you are in a safe area, (before the end of the event), so the phys-rep can be returned to its owner. If there is no tag, the item does not represent an in-game item and cannot be taken because it is merely a costume piece.

If you have a magic weapon or item phys-rep stolen, you must



immediately find one of the Rules Marshals for that chapter and turn over the magic item tag. You can find a Rules Marshal out-of-game.

If you have a piece of jewelry or other game item that you wish to make into a stealable item, you must obtain an item tag for that item. You can do this at logistics at any NERO event. The item will be evaluated to figure out its monetary value. You will then be required to pay the in-game amount that the item is worth.

Weapons

You must actually take the weapon you are stealing.

Once you have stolen a weapon, you should then head immediately to the designated area for stolen weapons (usually the NPC camp or an NPC Weaponsmith shop). You cannot actually keep that particular weapon phys-rep since it is the personal property of the player from whom you stole it, but the marshal in charge will give you the tag from that weapon which you can then attach to your own weapon phys-rep or attempt to sell in-game.

If your weapon is stolen, you should head to the designated area. That is why it is so important for you to write your name on your weapon! (In some chapters, you do not steal the weapon, but only the tag.)

Some monsters will have weapons that are stealable. However, for logistical reasons, these monsters will simply hand you a tag instead of the actual weapon.

Other in-game items

NERO often provides props such as maps, notes, books, and other informational items. If you find these in a module or on an NPC, you should ask a Rules Marshal to see if you need to return the props to NPC camp or if you can keep them. If you steal them from another player, you should have a Rules Marshal contact the person you stole them from out-of-game and make sure that they were stealable.

Searching a Person

If you waylay, kill, or control a person or monster through a spell, you may search that being. Simply say "I search you." All game items must be turned over at that point. Note that it is impossible to completely hide something on your body. If you are searched, you cannot claim that something was "really, really hidden." If you are searched, you also have the option of saying, "Go ahead and describe your search and I will tell you the results step by step." This is not only to help you to hide items, but it also takes up the time that the search should take. You must really have the item hidden where



you say it is. In other words, you can't say "I'm pretending to have a secret compartment in my shoe, and he didn't search for secret compartments!"

If someone steals your magic item, do not give them the tag that describes your magic item. Immediately go to a Rules Marshal and turn over the tag. It is up to the person who stole the item to find out what the item is and how it works. This applies to magical weapons as well.

Searching a Cabin

In order to search a cabin, you **MUST** have a marshal present. We cannot overemphasize this point! If you enter a cabin without a marshal, you are really breaking and entering and NERO may be forced to bring legal action against you!

The marshal does not have to actually be right next to you (after all, how can you sneak with someone else tagging along beside?), but the marshal must be within sight somewhere.

Once you have managed to successfully open the door, the marshal will then check the marshal's notes that will be affixed to the inside of the

door. These notes will list any magic spells that may be active in, or on, the cabin, which character cast these spells upon the cabin, who is invested in any *CIRCLES OF POWER* that are in the cabin, who is invested in the cabin's *WARD* (if one is present), and any other things that the local chapter requested be placed on the Marshal's Notes.

You must actually search the cabin yourself. The marshal will not simply look at the notes and go and retrieve items for you. Do not take any items marked "personal" or any items stored under a bed. In-game items may not be put under a bed. When you leave the cabin, you must show all items you have taken to the marshal. Only game items can be stolen! The marshal will return non-stealable items. The marshal is also there to make sure that you properly disarm any traps that may be on the door or window. Destroying property such as window screens or door hinges is not allowed.

Remember you can search anywhere in a cabin except for bags marked personal or behind dividing curtains or under beds.

However, not everything in gameplay is stealable, so always talk to a Rules Marshal if you have any questions or concerns.

Securing your Cabin

Tyrra can be an unsafe place, so it's always a wise idea to guard your valuables. There may be places in-game where you can buy or rent a lock for your cabin. Some of these places will also install it for you for a small fee. Of course, these locks can be picked by a good thief, but at least it will slow the rascal down. You can also buy or

make traps for your cabin. Each trap must be accompanied by the trap's item tag see Traps & Locks below.

It is a smart idea to take your personal items and put them under your bed. Any items placed under the bed are considered to be out of play, so don't cheat and put game items there. If you like, put a dividing curtain up in your cabin, and place all the beds and your personal items behind it. Put any game items in front of the divider.

If you are sleeping in-game during the night, make sure that your bed is in front of any dividing curtain or barrier you have put up.

Any special security precautions you take must be entered on the marshal's notes sheet in the holder on your cabin door. Make any appropriate entries there, with the spell labels and/or trap cards necessary. That way anyone marshaling a thief through your cabin can dole out any damage that the villain may take. If no precautions have been entered on the marshal's notes, then there is nothing protecting the cabin in-game!

Anyone who does not reside in a particular cabin caught reading the marshal's notes will be subject to disciplinary action. These notes are for marshals only, and only when marshaling a thief into the cabin.

Traps & Locks

In order to make a trap, you must have the skill *CREATE TRAPS*. This skill works on the Production system as described in the chapter "Physical Representations" on page 105. All trap designs must be checked and approved by a Rules Marshal from the chapter where the trap will be used. The trap must be approved at every event, regardless of whether it has been approved in the past. All traps must make a noise or flash a light or otherwise be constructed so that it is obvious when the trap has been set off. A trigger must be physically attached or connected to a trap.

Traps are never considered "NERO-safe" weapons and cannot be



thrown or used in battle as a weapon. Doors may only be secured through in-game means such as in-game locks or a Ward spell. The use of out-of-game locks, barricading a door closed with other objects or attempting to hold it closed against an intruder is not permitted.

Trap Types

There are 7 different types of traps each with different building parameters.

Weapon Traps

A weapon trap is a trap which contains a weapon on a spring-mounted mechanism. These traps cost 1 Production Level per 2 points of damage with a minimum damage of 2 and a maximum damage of 40. Weapon traps may be reset by anyone with the *DISARM/ARM TRAPS* skill without paying the cost to rebuild them.

These traps must be mounted to a door, wall or inside a large chest to be effective. If not mounted to a heavy, stable object of this sort, they cannot be set with enough force to be effective. You cannot attach these traps to a body.

The mounted weapon must be any standard NERO-safe boffer weapon. This is the only trap that can be blocked, Parried, Dodged or stopped by the *MAGIC ARMOR* spell.

Massive Mechanical Traps

Massive mechanical traps represent collapsing ceilings, rockfalls, giant scythes, and other such contraptions. They are completely immovable. They have a minimum size of 3" by 3" by 3". Anyone struck by any part of the trap when it goes off takes the full damage of the trap. Massive mechanical traps must be rebuilt after they are set off; they cannot be reset.

These cost 1 Production Level per 4 points of damage with a minimum damage of 16 and a maximum damage of 80. Massive mechanical traps are usually represented with pillows, plastic trash bags filled with newspapers, and other soft items. Whoever is touched by the phys-rep will take the complete damage from the trap.

Fire / Acid Traps

A fire or acid trap represents a trap which sprays a burning or caustic liquid in a 5 foot radius measured from the center of the trap phys-rep. Anyone inside this radius when it detonates takes the full damage of the trap plus the additional effects listed below.

In addition to a trigger and detonating mechanism, there must also be a physical representation for the oil / acid "container." The required size of this container is 216 cubic inches. The detonation mechanism must be attached to the container. The radius effect is measured out from this container.

The damage from fire traps can be negated by Cloak vs Fire or Guardian of the Four (Fire.)

These cost 1 Production Level per 3 points of damage with a minimum damage of 12 and a maximum damage of 60. This trap is destroyed when it detonates.

Explosive Traps

Explosive traps are very similar to Fire/Acid Traps except that the container represents the explosive. These traps have a 5' radius. All destructible items in the area of effect are destroyed. Armor will provide its numerical protection against the damage caused by the blast and then be destroyed. Sealed containers will not protect items from explosions. All in-game items except un-shatterable items will be destroyed by an explosive trap. Items within an indestructible sealed container will not be affected if they are in the radius of an explosive trap, unless the trap is inside that container or the container is open. Defenses such as *CLOAK* or *BANE* versus *SHATTER* or *DESTROY* have no effect against an explosive trap.

Explosive traps, like Fire/Acid traps and Gas traps, must have a "container." This container is always 216 cubic inches, regardless of the trap's effects.

To make these traps costs 1 Production Level per 2 points of damage with a minimum damage of 30, and a maximum damage of 60. This trap is destroyed when it detonates.

Gas Traps

The Production Level cost for creating a gas trap is equal to the highest Production Level gas the trap is designed to hold. The trap builder must also include a dose of the gas poison in the trap itself. A gas trap is rated at the Production Level used to make it. To make a gas trap with a *PARALYZE* gas within will cost 9 Production Levels for the trap (and 9 production Levels for the gas, which must be supplied separately).

Remember that the trap must contain both a trap card and the gas poison tag. Gas which is contained in a Gas trap cannot be removed, reused, or "salvaged," under any circumstances.

Multiple *CAUSE DAMAGE* gases can be placed into a single gas trap up to the limit of the level of the trap but no other gases can be "stacked" to increase their damage potential or mix their effects.

These traps have a 5' radius. Anyone inside this area when the trap goes off will be affected as if they had been struck by a gas poison of the same name. The effects of any gas trap, even traps with multiple gases, will be blocked by a *POISON SHIELD* or the skill *RESIST POISON*. If two or more traps have the same trigger, then they are all set off together and one *POISON SHIELD* or *RESIST POISON* will block them all.

Gas traps, like Fire/Acid traps and Explosive traps, must have a "container." This container is always 216 cubic inches, regardless of the trap's effects. Gas trap mechanisms that go off are reusable though the gas inside will have to be replaced.

Alarms and Noise Makers

These are traps that do no damage but set off loud alarms and other noises. They cost 1 Production Level each to make. Alarms and Noise Makers do not have a minimum container size. They are as large, or as small, as they must be to make a noise. When this type of trap is tripped, it must make its own noise. Although it takes a person with *DISARM TRAPS* to disarm an Alarm or Noise Maker trap, once it has been set off anyone can attempt to muffle the trap's sound by throwing blankets over the trap, or by using some other method.

Trap Mechanics

Setting Traps

Setting a trap takes the real setting time of the trigger followed by 60 seconds of counting while both hands remain on the trapped item. Both weapon traps and massive mechanical traps must be mounted on large or heavy objects to be properly set.

Backfire

If either hand is removed from the trap, or the person setting the trap is struck by a physical blow or packet attack, then the trap backfires on the setter. The backfire will hit only the person setting the trap; there is no radius effect.

Setting off a Trap

Traps can be set off in 3 ways: by being moved, being destroyed, or their trigger being sprung. The trap must be armed to be set off.

NAME	EFFECT	DEFENSE
Massive Mechanical	x	Armor
Explosive	Destroy	Armor
Flame/Acid	x	Armor, Cloak, Bane
Gas	Poison	Resist Poison, Shield
Weapon	x	Parry, Dodge, etc

Being Moved

After a trap has been set, it cannot be moved more than five feet without automatically setting it off, even if the person moving it has a *DISARM TRAPS* skill. In the case of weapon traps, they will automatically hit the person carrying the trap.

Destroyed

An armed trap will be set off (then destroyed) if affected by a Shatter or Destroy effect. This includes traps and other game effects that duplicate *SHATTER* and *DESTROY*. Traps that are not armed will not be set off in this manner (although they will still be destroyed).

Trap Triggers

All traps must have a real, physical trigger. Setting off the trap must produce a noise or light that is detectable by an impartial observer. It must always be possible to see how to disarm a trap, although it may require light and a small mirror. To be used, a trap must be approved by a Marshal.

A simple trap trigger can be made out of a clothespin (the kind with a spring in it), two tacks, some string or thread, two pieces of wire and a small piece of cardboard. Attach the wire to the tacks just below the heads of the tacks.

Now pull the clothespin apart and place the parts outside-down on a table. Push a tack through each half of the clothespin so that the two tack heads will contact each other when the clothespin closes. Reassemble the clothespin.

Punch a small hole in the piece of cardboard and tie one end of

the piece of thread to the cardboard. The cardboard can now be placed between the jaws of the clothespin to keep the tacks from conducting electricity.

The other end of the string can be tied across a doorway or path so that when someone hits it with their leg it will pull out the cardboard and make a connection. This trigger can then be used to set off a buzzer or other device to indicate the trap has gone off. You can also deliberately set off a trap like a claymore mine if you use a pull cord.

Dealing Damage

Traps that have an area effect have their effect area measured from the center of the trap phys-rep. If there is a large, trapped box with

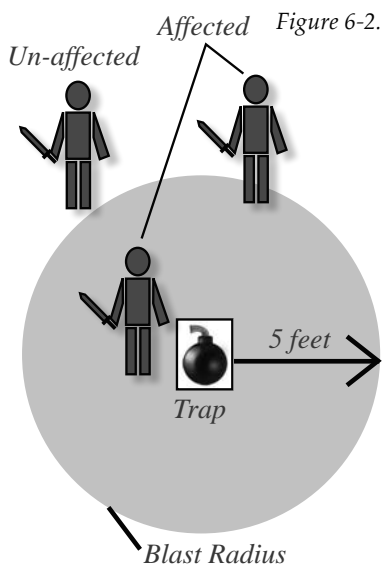

a 10 foot tripwire attached and a player sets the trap off at the end of that tripwire they are not affected by the trap since the phys-rep (the center of the trap radius) would be 10 feet away. It is not measured from the tripwire/snapper/etc, but from the rep for the trap itself. This will allow you to have a 50ft pull cord on a trap box in the field and use it like a claymore mine since the effect goes off from the box/rep/trigger and not from the cord.

Disarming Traps

Traps may be disarmed by any method that does not permanently destroy the trap. For example, popping a battery clip off would represent disarming a spring.

Permanent damage is defined as any damage that cannot be fixed by the marshal within ten minutes with no tools.

If the trap was successfully disarmed, the gas trap may of course be reset, but in no case can the gas be taken from the trap.

Containers

Fire / Acid, Explosive and Gas traps must have a container representing their explosive or liquid contents. This container must be at least 216 cubic inches in size.

Picking Locks

Anyone wishing to put a lock on a box, chest, or door must use one of the NERO approved locks (for sale by various characters). These locks are simple and can be fairly easily picked using thieves' tools.

Generally speaking, if you wish to place a lock on your door and you can pick the lock yourself in the presence of a Marshal, then you will be allowed to use that lock. Combination locks are not allowed to be used by players (although they may be found in modules).

Marshals

Marshals are the referees and guides of NERO. They will be with you in modules and available for you at other times. If you have a question about rules or if you need someone to witness an action in order to make it official, you must see the appropriate marshal.

If there is a dispute over a rules interpretation by one or more players, then a Marshal should be consulted. If you are on a module, then your Module Marshal will be the arbiter. If you are on a full NERO event, then you will need to find a Full Marshal or one of the marshals on duty for the event.

If you wish to appeal a Marshal's ruling, you can speak to an Adjudicator. When dealing with a NERO Marshal or other representative, you can help yourself and your case considerably by staying calm. Present your case and once the ruling is made, play along with it. Your marshal may be aware of something you have missed, or may be making a decision based on what was intended by the rule. If you feel the marshal's judgment was incorrect, you can bring the ruling to adjudication later. Don't dwell on it in the meantime or it will spoil your enjoyment of the rest of the game.

You should also try not to nitpick details of a situation. You should understand and follow the intent of the rules. Play fair and be considerate of everyone's enjoyment of the game. You will be taken more seriously and be respected by those who have to deal with you. Arguing the specific wording of a rule or taking advantage of a





misprint can look like manipulation of the rules for your benefit and will not win you any friends in the long run.

Marshals are appointed positions only. Generally, marshals remain in game play as their characters but are able to step in and make judgments if needed. Anyone impersonating a marshal will be subject to immediate disciplinary action, as are marshals who attempt to marshal themselves or their friends in game play.

Marshals are never allowed to marshal themselves through an encounter, and a marshal should never marshal his or her adventuring group if at all possible. If a marshal appears biased, it ruins the credibility of the marshal to give fair judgments in future decisions.

Cheating and Metagaming

- Ⓜ Players who are caught cheating or metagaming raise the risk of being suspended or kicked out of NERO. Remember, you do not have a right to play our game.
- Ⓜ If you know of someone cheating, you should immediately report this to a marshal.
- Ⓜ Metagaming is harder to call. It is difficult to keep from bragging about your adventures to people out-of-game. And sometimes people do not remember if they got information in-game or out-of-game. If you do not want people to act of information they have discovered out-of-game, the best solution is to never tell any secrets!

- Ⓜ Peer pressure counts for a lot here. Don't let your teammates cheat or metagame. Sooner or later, he or she will get caught and everyone will assume that you are guilty as well.
- Ⓜ This leads to a tender subject: Gossip about cheaters and metagamers. It is common for players to gripe about other players and call them cheaters or metagamers but the fact is that NERO is very proud of the fact that we have so few. Gossip can ruin our game. We all need to watch what we say about other players. Hearsay and innuendo have no place in NERO. If you think that someone is cheating or metagaming, don't whine and complain to your friends about it- report it to a marshal! And if a marshal comes to you and asks about a possible cheating situation, please cooperate and don't take it personally.
- Ⓜ If someone makes an accusation against someone else ask, "How do you know that?" If they have firsthand knowledge, ask "Why haven't you reported that to a Marshal?" If they don't have firsthand knowledge, refuse to listen to them.
- Ⓜ Only by working together and trusting each other enough to give the benefit of the doubt can we keep this game running fairly for everyone. Your cooperation is crucial to make sure we have a fair, fun game.

Build Cheating

Any player that knowingly reports a false amount of build or levels, or abuses the award system will be suspended from all NERO® Chapters for a minimum of six months. In addition, their character will be reduced to one half of its actual build level.

Example – Joseph is 10th level with 106 build. He goes to an event in another chapter, tells the check in staff he doesn't have his card, but is 12th level with 123 build. After he is caught, he will be suspended for a minimum of 6 months, and his new amount of build will be 53.

NERO Sportsmanship Policy

All NERO Participants

- ☞ Follow the spirit of the rules, as well as the letter of the rules.
- ☞ Play fairly and honestly.
- ☞ Be considerate of all other NERO participants.
- ☞ Remember, everyone has the right to enjoy NERO as much as you do.
- ☞ Contribute to the fun of all NERO participants.
- ☞ Don't play in a style that detracts from the fun of the event, or anyone's chance to have fun at an event.

Staff, Marshals, etc...

- ☞ Abide by the expectations that apply to all NERO participants.
- ☞ It is your job to run the event. Remember, you are not playing against the players. Everyone's enjoyment of the event is your top priority.
- ☞ All participants must be treated equally and equitably, by you and by other participants. Favoritism will not be tolerated.
- ☞ Run events in a professional manner. Remember that you represent NERO to anyone present at an event, whether participating or observing.

Administration (National, Local, etc...)

- ☞ Abide by the expectations that apply to all NERO participants, Staff, Marshals, etc....
- ☞ Respond and communicate in a timely, respectful, and articulate manner.
- ☞ Uphold the authority of your staff, and do not overrule them without careful investigation.

Code of Conduct

NERO expects its members to act responsibly as adults, to respect other players, and abide by the NERO rules and policies.

NERO will not tolerate dangerous non-game physical violence, damage or theft of non-game items or property, vandalism, display of pornographic materials, open and gross lewdness, or any actions by an individual or group which demonstrates a wanton lack of respect for the safety or security of the people, property or environment at any NERO site.

NERO does not condone any form of out-of-game bigotry or discrimination against any group or individuals because of their out of game afflictions, including race, gender, age, religion, ethnic background, ideology, sexual orientation, physical appearance, handicap or disability. Or any other part of a player's background.

All players in the NERO game are responsible for knowing the rules contained in the rule book and following them in the course of play. NERO reserves the right to remove you from play or otherwise limit your participation in NERO if it is found that you have disobeyed the NERO rules. NERO will make every reasonable effort to inform you of all rules changes, interpretations and corrections.

Remember that in all cases it is the spirit of the rule and not the literal meaning of the rule that should guide you. If you find a loophole in a rule that obviously goes against the rule's intention, then you should bring this to your local rules committee. Knowingly trying to take advantage of this unintended loophole is cheesy at best and could be considered cheating at worst if your interpretation is grossly contrasted.

If there is a dispute over a rule's interpretation between players, a Marshal should be called to act as an arbitrator. When dealing with a marshal or other NERO representative, you can help by presenting your case calmly and by answering all of the marshals' questions as directly as possible. Once a decision is made, play along with it and don't question the marshal's ruling - the Marshal may have been aware of facts unavailable to you or may be making a decision based on what was intended by the rule.

If you feel a Marshal's ruling was incorrect or unfair, you may bring this to the attention of an Adjudicator.

Do not nitpick on the details of the situation - understand and follow the intent of the rules. If you play fair and be considerate of everyone else's enjoyment of the game, your comments will be taken more seriously and will be better respected.

NERO will remove any member who NERO suspects is intoxicated or high.



Content

References to explicit sexual behavior or concepts, particularly violent ones, are not allowed.

Safety

Alcohol

Alcohol is prohibited from NERO events no matter what your age. In all cases, all laws regarding Alcohol must be adhered to. Our adventures are not an excuse for getting drunk out in the woods with your friends. Anyone caught with any controlled substance will be subject to severe disciplinary action. Take this point very seriously and report anyone you see with alcohol or drugs.

Medic

If your character or another character is injured In-Game, you can shout for a "Healer". However, if you or someone else is injured in real life, shout for a Medic and call a Hold. Do not call for a Medic unless it is a Out of Game emergency. If you hear the call for a Medic, drop to one knee and remain still and silent. Only the persons who have been identified as a Medic by Chapter Staff should respond to the call of Medic.

Real Weapons

If you bring a real weapon into a NERO game, you will be told to put it away. Real weapons can never be carried on your person. (Swiss army knives, small thieves' tool knives and other such devices are acceptable.) Daggers may be carried for eating/utility purposes, but they must be "peace bonded" (tied in a sheath) when not at the table.

Page Status

A Page is a person who, for one reason or another, cannot enter combat. Some chapters will allow children to play NERO under Page status, and adults with a medical condition can also choose to play NERO as a Page. If you are planning on bringing your children to an event, it is best to contact the Chapter first for details. In most chapters, any child under 14 years old must be a Page. A Page can be a member of any race and any class, but cannot use combat skills or throw packet delivered attacks.

A Page should never be struck with a weapon or claw. In order to attack a page, you can point your weapon or packet at the Page and state "I kill you, page!", or "I down you" (bleeding out) or any number of other actions. If there is someone within 5 feet of the Page, they can choose to defend the page and block your attack. To do so, they must state "I defend you" and role-play accordingly. A person cannot defend a page if they do not have a weapon, shield, or other ability to do so. All pages must wear an Orange headband to signify they are under Page status.



Smoking

Smoking is only permitted in designated smoking areas. Generally, you are discouraged from smoking in public areas because of consideration for the other players, for fire safety regulations, and because it takes away from the medieval feel of the games.

Torches and Flames

The rules on torches and flames vary based on the campsite's rules. Generally speaking, torches are not allowed. No open flames are allowed in cabins, including candles (although candle lanterns and oil lanterns are fine). In any event, flames are never to be left unattended.

In order to use a flashlight for in game purposes, you must have someone cast an Illumination spell. The flashlight must be diffused by either taping a cloth over the end or using a red filter and must be pointed towards the ground or up in the air. A flashlight can never be pointed near a person's face. If at all possible, please avoid using flashlights as they distract from the medieval feel of the game.

A *LIQUID LIGHT* elixir can also be used but preferably the phys-reps for these should be chemical "light sticks." The small battery operated glass "candles" and other small battery operated lighting devices cannot be used while adventuring. These things tend to break very easily and can be dangerous. If you want to use your flashlight to represent a candle or a small torch, you must have in your possession somewhere a real candle or torch that the flashlight represents.

Quick Start Character Gen.

1. Choose a Race:

Table 6-4.

<i>Racial Comparison Chart</i>		
<i>RACE</i>	<i>ADVANTAGES</i>	<i>DISADVANTAGES</i>
Barbarian	+2 Body Points to Start Barbarian Slay: 10BP, once Detect Celestial Magic: 2BP	Double cost for Scholarly Skills
Biata	Break Charm: 2BP Resist Charm: 3BP Resist Sleep: 2BP	Cannot buy Read Magic
Drae	Resist Charm: 3BP Resist Sleep: 2BP Half Cost for Archery	-2 Body Points in the Day Cannot use Two Handed Sword Cannot use Two Handed Blunt
Dwarf	+1 Body Point to Start Resist Poison: 4BP -1 Cost for Smithing	Double cost for Read Magic Cannot use Polearm, Staff, Two Handed Blunt, Two Handed Sword
Elf	Resist Charm: 3BP Resist Sleep: 2BP Half Cost for Archery	-1 Body Point Cannot use Two Handed Sword Cannot use Two Handed Blunt
Gypsy	Gypsy Curse/Remove Gypsy Curse: 2BP	None
Half Ogre	+2 Body Points to start Strong arm: 10 BP, once	Double cost for Scholarly Skills
Half Orc	+2 Body Points to start Strong arm: 10 BP, once	Double cost for Scholarly Skills
Hobling	Resist Poison: 4BP Half cost for Pick Locks Half cost for Arm/Disarm Traps Hobling Dodge: 12 BP, once	-1 Body Point to Start Cannot be a fighter Cannot use two handed weapons
Human	None	None
Mystic Wood Elf	Break Charm: 2BP Resist Charm: 3BP -1 Cost for Craftsman	Must buy skill from <i>Table 3-3 on page 30</i> at each level
Sarr	Resist Poison: 4BP Scenting Ability	Cannot use any blunt or any ranged weapons
Scavenger	Resist Poison: 4BP Scenting Ability	Double cost for Scholarly Skills

shield. Reading and writing can be necessary for your backstory so make sure to pick it up if you need it. If you want to go scholar you have the choice between Earth (healing magics, binding magics, necromancy) and Celestial (Damaging magics, Binding magics). Be careful, in most chapters necromancy is illegal in game. Rogues can learn to strike for additional damage from behind or *WAYLAY* which can be very useful. The Templar is a nice balance of spells and weapon skills, but you should pick one to focus on early. The key to a starting character is remembering to specialize rather than spread your skills out, you'll be quickly earning the build points to spread out and having a single solid set of skills for your first event will enable you to have more fun!

Character History

You should write a character history and submit it to your local chapter staff for approval. See "*Be a Successful NERO Player*" on page 9 for more information about writing a character history.

Table 6-5.

<i>Class Starting Stats</i>		
<i>CLASS</i>	<i>BODY</i>	<i>WEAR ARMOR</i>
<i>Fighter</i>	8	20
<i>Rogue</i>	5	15
<i>Scholar</i>	4	10
<i>Templar</i>	5	15

2. Choose a Class:

3. Choose your Skills

As a new character you start with 30 build points (level 2) and should get skills that will allow you to enjoy your first NERO game and be effective. As a fighter you will want the skill to use a weapon (possibly two!) and maybe a



adventuring
gear

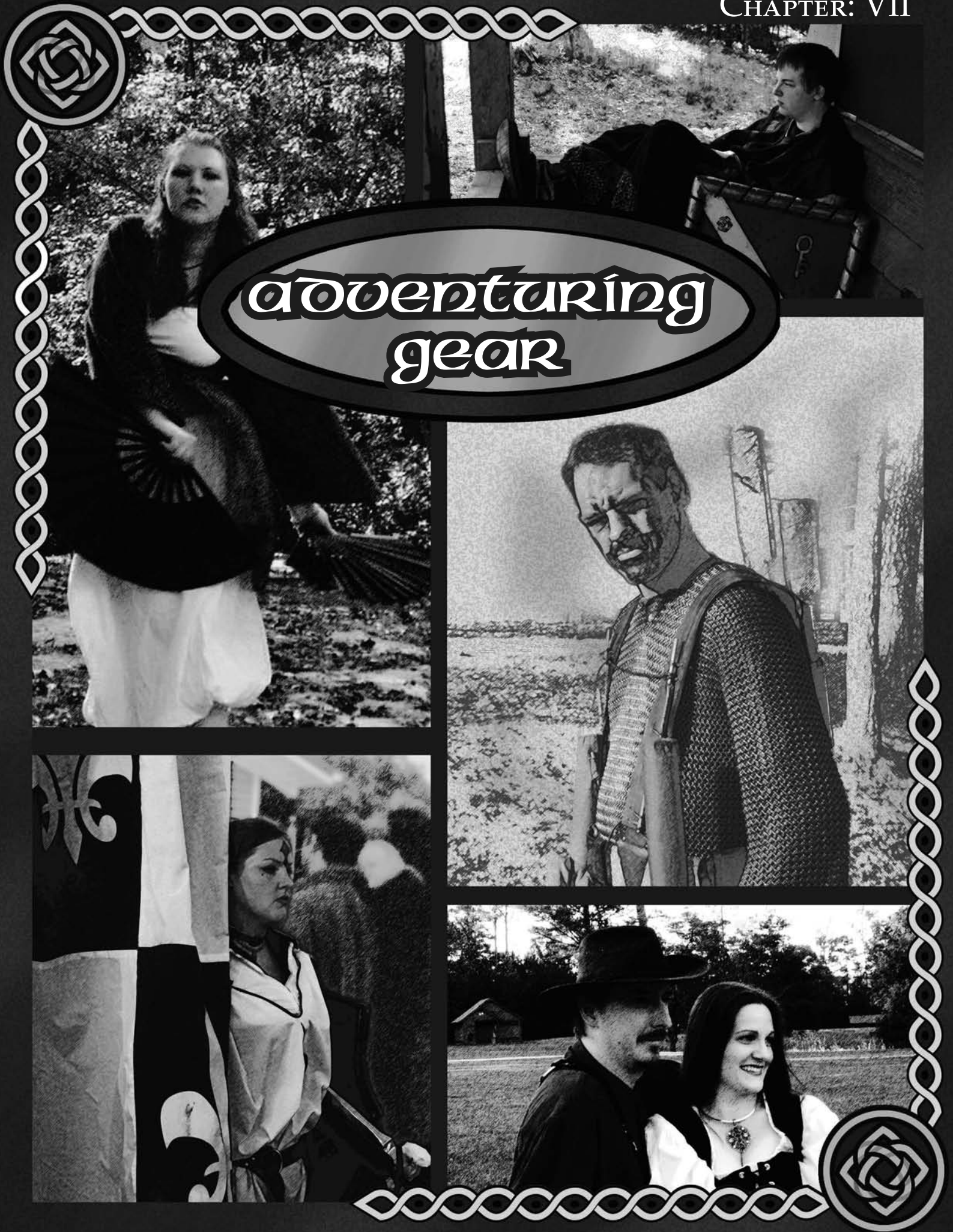

Weapon prod. Table 7-1.

ITEM	P.LEVEL
Bludgeon	1
Bow	4
Crossbow	4
Dagger	1
Hatchet	1
Javelin	2
Long Axe	2
Long Hammer	2
Long Mace	2
Long Sword	2
Polearm	4
Quiver of Arrows / Bolts (Quantity 20)	2
Sap	1
Shield	2
Short Axe	2
Short Hammer	2
Short Mace	2
Short Sword	2
Spear	2
Staff	3
Throwing Dagger	1
2 Handed Blunt	4
2 Handed Sword	4

Scroll prod. Table 7-2.

EFFECT	P. LEVEL
Awaken	4
Bind	4
Delayed Endow	2
Destroy	6
Detect Magic	2
Dispel Magic	8
Dragon's Breath	8
Elemental Blade	4
Enchanted Blade	6
Endow	1
Flame Bolt	4
Fumble	1
Guardian of the Four	7
Ice Bolt	3
Ice Storm	7
Lightning Bolt	2
Lightning Storm	6
Magic Armor	2
Magic Missile	1
Pin	2
Reflect Magic	8
Release	5
Repel	2
Shatter	3
Shield	1
Shield Magic	5
Shun	4
Silver Aura	5
Sleep	6
Stone Bolt	5
Web	5

Potion prod. Table 7-3.

EFFECT	P. LEVEL
Awaken	4
Bless	1
Cause Critical Wounds	6
Cause Disease	3
Cause Light Wounds	1
Cause Mortal Wounds	8
Cause Serious Wounds	4
Cause Wounds	2
Cure Critical Wounds	6
Cure Disease	3
Cure Light Wounds	1
Cure Mortal Wounds	8
Cure Serious Wounds	4
Cure Wounds	2
Curse	7
Dispel Magic	8
Elemental Shield	6
Magic Armor	2
Purify Blood	5
Reflect Magic	8
Release	5
Remove Curse	7
Remove Drain	7
Remove Physical Affliction	6
Remove Weakness	3
Restore Limbs	7
Shield Magic	5
Sleep	6
Taint Blood	5
Unparalyze	8
Weakness	3
Wither Limb	7



Armor prod. Table 7-4.

POINT VALUE	P. LEVEL
1 - 10	1
11 - 20	2
21 - 30	3
31 - 40	4

Physical Representations



f you acquire any potions, scrolls, poisons, or alchemical substances during your adventures, then they should have appropriate Tags attached. If you create your own through the Production system, then you must supply a physical representation for the item, and the tag must be attached. This physical representation can be stolen, at which point the thief will take the tag and the item.

A scroll or potion that does not have a tag attached cannot be used. If the tag is lost, stolen or destroyed, the item is not usable. The tag by itself is not the item. If someone hands you an out-of-game tag and says "Here, drink this!" you should reply "Drink what?" since nothing is being shown to your character in-game. This rule exists because after all, these things take up room and add weight. You can't carry around 100 potions as easily as you could 100 tags.

If your character finds or is given a magic weapon, you are sometimes given a physical representation for it (You should return it to the NERO Chapter you found it in when its magic expires). You cannot alter the weapon in any way except to repair it when needed. If the phys-rep wears out, then another must be built that looks just like the original. Magic items cannot ever be modified and must always look the same. This has the advantage of making it easy to spot your stolen sword if you should ever see it again. See "So you want to be a thief?" on page 94.

Game Items

All game items (such as jewelry and magic items) should be labeled with a number. This is for the marshals to be able to tell the worth of the item and the magic use (if any).

If you steal an item that does not have a number on it, then you should immediately return it as it is obviously personal property and not part of the game. See "So you want to be a thief?" on page 94.

Armor

Armor points

There are three ways a player may possess Armor Points: Physical Armor, Dexterity Armor, and Arcane Armor. The three types may be used together and add to your total

Special Abilities Table 7-5.

ABILITY	P. LEVEL
Silvering a Weapon	4
Strengthening an Item	4
Improve a weapon + 1	3
Improve a weapon + 2	9
Improve a weapon + 3	18
Enhance Armor	x2



of Armor Points. You can not use more armor points than your character can wear.

Wear Points

Your character's Wear Point total is the limit of armor points you can use or "wear" at one time. Your base Wear Point total depends on your class, as shown in figure 7-1.

Figure 7-1.

Class	Wear pts
Fighter	20
Templar	15
Rogue	15
Scholar	10

Wear Bonuses

You can add Wear Points to your base by purchasing the skill *WEAR EXTRA ARMOR* or by wearing good costuming.

Wear Extra Armor: The skill wear extra armor adds 5 wear points per purchase to your characters wear point total up to a maximum of 40 points.

Costume Bonus: Any player will be awarded five wear points simply for being fully in costume with their entire visible costume fully fitting with the in game atmosphere see "Costumes" on page

Armor Physical Representation Values Table 7-6.

BODY LOCATION	NAME	PLATE	CHAIN MAIL	LEATHER
1. Head	Helm	3	2	1
2. Chest	Breastplate	9	6	3
3. Back	Backplate	9	6	3
4. Left Arm	Left Brassart	3	2	1
5. Right Arm	Right Brassart	3	2	1
6. Left Forearm	Left Bracer	3	2	1
7. Right Forearm	Right Bracer	3	2	1
8. Left Thigh	Left Cuissart	3	2	1
9. Right Thigh	Right Cuissart	3	2	1
10. Left Leg	Left Greaves	3	2	1
11. Right Leg	Right Greaves	3	2	1
TOTAL		45	30	15



Plate

ChainMail

Leather

121. A marshal must be consulted to see if your costume warrants the bonus. You should do this at every chapter you go to as some chapters have different criteria to make this decision.

The maximum Wear total a player can have is 40 (45 with good costuming), no effect can augment this bonus higher by any means. Armor points granted by the spell "Shield" are considered Armor but do not count toward your Wear Point total.

Example, Mandrake the scholar has 10 base wear points, he purchases Wear extra armor and now has 15 wear points. His costume is reviewed by a marshal and is given the 5 wear points for costuming. So he can now wear up to 20 Armor points.

Physical Armor

The Physical Armor Types are Leather, Chain Mail, and Plate. Table 7-6 shows the value of each Armor Type for each Body Location. Each location is worth one point for leather, two points for chain, and three points for plate except the chest and back which are worth three times as much since they cover a larger area.

A suit of armor may be rejected at any point on grounds of safety for such things including, but not limited to; protrusions, sharp edges, and unsafe materials.

- Ⓜ Characters may select the armor type to use at each separate body location, making it easier for players to create their own personalized armor. Each location is considered covered in armor if at least three quarters of the entire area is covered. Locations with overlapping armor types count as the higher type.
- Ⓜ A Suit of Armor is evaluated by adding the armor point value for each body location covered.
- Ⓜ Armor does not have to be real to count for armor points, so long as it looks real.
- Ⓜ The tag for armor allows a character to gain protection from a phys-rep rated up to the value on the tag. To claim the entire value of an armor tag the player must wear a phys-rep which has been evaluated by a marshal to be worth at least the value of the tag, you cannot wear 20 points of coverage, have a 30 point tag and claim 30 points of armor in game.

Leather: Leather is any material, natural or synthetic, that looks like leather.

Chain Mail: Chain Mail is made of material of interlocking links whose holes are small enough not to easily catch a finger.

Plate: Is armor made of rigid material that does not easily deform, or of material that accurately recreates the look of plate, either medieval or fantasy. Plate is made up of large pieces of metal or metal looking material.

Refitting Physical Armor

When a suit of armor takes damage it can be refitted to its full value. Refitting in this way can only be done by the armor's wearer, and requires that the person spend an uninterrupted minute during which he can use no other game skills, cannot walk around, or be struck in any way. You may choose to interrupt yourself at any time. During the refitting the character will adjust (i.e. tighten straps, reposition plates) his armor so that it offers the best protection possible. If the character is struck by any packet or weapon, the refit is interrupted for no effect and must be begun again.

The smithing special ability *RAPID REFIT* and the spell *REFIT ARMOR* can also refit physical armor.

Weapons

WEAPON COMBAT

Safety is always the primary concern in weapon construction. Unfortunately, even the safest weapon could cause injury if improperly used. Therefore, in addition to safe weapon construction guidelines, practice in the use of the weapon is needed to ensure that all players enjoy the game as much as possible. Below are additional restrictions on specific weapons

Latex Weapons: may never be used for thrusting, stabbing or poking.

Blunt Weapons: If a blunt weapon does not have a "head" on it, it will inflict one less point of damage than normal. Blunt weapons may not be used for thrusting, and are required to have a padded thrusting tip for safety reasons.

Bows: You can use the bow in combat for blocking, but you may not attack with it. Once it blocks an attack, the bowstring is considered cut or unstrung by combat. The PC cannot fire arrows from it until he restrings the Bow (see below). For safety reasons, no taut bowstrings are allowed though a loose one may be used to sling the bow for carrying.

Restringing involves at least 3 seconds of role-play. No physical representations for extra bow strings are needed.

To Fire, the Bow must be held in front of the archer at arm's length and must be aimed at the target when the packet is thrown. The archer must take the packet out of the quiver, touch the packet to the hand holding the bow, then throw. The packet must be thrown in the normal flight path of an arrow fired from the bow. It cannot be thrown overhead or around corners. It cannot be "flicked." The damage call must be completed before throwing the packet.

The hand throwing the arrow (yellow packet) is the hand that concerns Proficiencies. Master Proficiencies carry over to archery.

All Vorpal Poisons, Enchanted Blade, Silver Aura and Elemental Blade spells work normally. Vorpal tags are to be taped to the bow, not the packet.

Damage Aura or Magic Aura upon a bow confers the ability for the archer to throw packets for the weapon type "magic." All weapons that fall under the skill Archery will have the weapon type of each missile altered if the weapon itself is targeted by a magical aura of any type. This includes a Damage Aura, Elemental Aura, and/or Magic Aura, and means that each individual missile does not need to be targeted by the formal magic spell in order to create the desired effect.

Bows that are un-shatterable still need to be restrung after blocking.

Real bows and arrows are not permitted.

Spears: One handed spears can only be used to perform thrusting attacks and can never be thrown. A character hit by any part of a spear other than the 8 inch head takes no damage.

Two handed weapons:

Two handed weapons must be used with both hands at all times. If you lose the use of one arm (as from a *WITHER LIMB* effect), then you cannot wield the weapon at all.

Weapon Safety Checks

Before every NERO event, all weapons must be approved at check-in by the weapons marshal. Since the requirements for the construction of weapons are fairly strict, it is not unusual for a weapon to be disqualified at check-in. Even a weapon which qualified at a previous event may be disqualified (Weapons do wear out). NERO reserves the right to fail any weapon that is deemed unsafe or hazardous.

Any experimental weapon using unusual materials can fail safety check at any time. Bring a couple of standard weapons with you as a backup in case yours fails inspection. Often the deficiency can be corrected with the addition of a little open cell foam or tape, so it is good to bring these extra supplies with you in case your weapon is not allowed so you can fix it.

If you are having trouble with weapon construction, then bring what you have so far to a NERO event, and you can show it to the marshals who will give you a hand when they can. The old saying "practice makes perfect" is especially true with both weapon making and use.

Weapon Tags

Every weapon must have two tags. The first is the Weapon Safety Tag. This tag proves that your weapon has gone through safety check and is approved to be used for that event this tag will be affixed to the weapon.

The second tag is the Weapon Tag. This is the tag that shows that the weapon is in-game. When you purchase a weapon from a weaponsmith or from logistics, you will be buying this tag to keep on you.

A player may only carry as many tags as he/she has physical representations.

Some weapons can be strengthened to withstand two or more Destroy or Shatter spells. When you have this done to your weapon, you will be given a new tag to reflect the changes. Weapons can also be silvered which can be very useful when fighting certain monsters, as with strengthening, you will receive a new tag. See "Smithing*" on page 42.





Weapon Construction

Weapon combat is a large part of the NERO game. Because of NERO's reliance on weapons, proper weapon construction is necessary to insure safe yet semi-realistic combat.

The guidelines in this section cover making a boffer weapon and choosing a latex or other manufactured weapon for play in the NERO game.

Pre-made weapons

There are a number of manufactured weapons that fall into the NERO guidelines for safety. If you purchase a pre-made weapon, it is your responsibility to determine the type of construction that was used. You must know what type of core the weapon has and what type of foam was used. Latex weapons are not required to have a thrusting tip, and may never be used for thrusting, stabbing or poking. Latex and boffer swords are available for sale and many can be used for NERO combat resolution. A current list of approved vendors and styles for latex weapons as well as latex weapon construction guidelines can be found online at www.nerolarp.com

Make Your own

You may also choose to make your own boffer or latex foam weapons. Making a weapon can range from very simple to very hard depending on the materials you choose and the design of your weapon. The following sections walk through the construction of a very simple weapon, but also provide information about some advanced materials you can try later on. It is highly recommended that you build a simple weapon for your first attempt.

There are a number of weapons that fit within a medieval fantasy setting that are not mentioned here. NERO allows creativity in developing new weapons but all must be approved before use. Experimental weapon types must conform to the basic standards of safety. You should check with the marshals before and during construction so that you do not end up wasting time and materials on a weapon that will not be allowed in the game, even so it still may not pass in all NERO chapters.

Weapon Parts

Below is a list of terms that will be useful to know when constructing a weapon. These terms detail sections of the weapon and what they are used for.

Thrusting Tip

A thrusting tip consists of at least two inches of open cell foam padding beyond the end of the pipe insulation. If the foam tip is too small, opponents could get hurt with a stiff thrust. If the tip is too large, it could easily break off or fold over, making it useless. All thrusting tips do count towards the weapon's overall length. The tip must collapse about 50% of its length when pressure is applied. The tip should also be the width of the weapon, and should not easily fit in an eye socket. Weapons with two possible striking ends, such as a staff, should have thrusting tips on both ends. For weapons with heads, the thrusting tip may be incorporated into the head design.

Blade/Shaft

This is the section of the weapon that is above the grip of the weapon. Blade/Shaft lengths of weapons can be determined by measuring from the end of the grip to the end of the thrusting tip. The Blade/Shaft area must be continuous 5/8" closed cell foam.

Head

Some weapons, such as a polearm, hammer, or spear, have an additional element(s) added to the weapon. The head(s) extend outwards from the shaft, must be a minimum of 6 inches in length along the shaft, must be made of open cell foam, and must be at least 1 inch thick or thicker. Each head can be a maximum of 2 cubic feet. The head must be positioned near the top of the weapon.

Crossguard

A crossguard is used in certain types of weapon and is a blocking surface that is perpendicular to the weapon. This blocking surface cannot have any kind of core inside of it, and can only be constructed of foam, and is a maximum length of 18" across.

Grip

This section of the weapon is the location where the weapon is held. With the exception of the special cases listed above, this section of the weapon does not need to be padded. The length of the grip is the length of the weapon from the bottom of the blade/Shaft to the inside of the pommel *see figure 7-1*.



Weapon Construction						Table 7-7.
WEAPON NAME	BLADE/SHAFT LENGTH	HEAD	TOTAL LENGTH	CORE SIZE	GRIP LENGTH	BASE DAMAGE
<i>RANGED</i>						
Bow	x	x	34"-58"	1/2"	5" - 14"	x
Crossbow	x	x	12"-24"	1/2"	1" - 8"	x
<i>MISSILE</i>						
Arrow	x	x	12"	x	x	3
Bolt	x	x	12"	x	x	3
Javelin	x	x	36"-40"	x	x	2
Throwing Dagger	x	x	12"-18"	x	x	1
<i>SMALL</i>						
Bludgeon	8" - 17"	6" - 12"	12"-26"	1/2"	1" - 6"	1
Dagger	8" - 17"	x	12"-26"	1/2"	1" - 6"	1
Hatchet	8" - 17"	6" - 12"	12"-26"	1/2"	1" - 6"	1
Sap	8" - 17"	6" - 12"	12"-26"	1/2"	1" - 6"	1
<i>SHORT</i>						
Short Axe	18" - 24"	6" - 18"	27"-34"	1/2"	1" - 14"	2
Short Hammer	18" - 24"	6" - 18"	27"-34"	1/2"	1" - 14"	2
Short Mace	18" - 24"	6" - 18"	27"-34"	1/2"	1" - 14"	2
Short Sword	18" - 24"	x	27"-34"	1/2"	1" - 14"	2
<i>LONG</i>						
Long Axe	25" - 36"	6" - 18"	35"-46"	1/2"	1" - 14"	2
Long Hammer	25" - 36"	6" - 18"	35"-46"	1/2"	1" - 14"	2
Long Mace	25" - 36"	6" - 18"	35"-46"	1/2"	1" - 14"	2
Long Sword	25" - 36"	x	35"-46"	1/2"	1" - 14"	2
Spear	20" - 45"	8"	48"-58"	3/4"	1" - 30"	2
<i>TWO HANDED</i>						
Polearm	38" - 44"	18" - 24"	60"-72"	3/4"	1" - 36"	3
Staff	24" - 32"(x2)	x	60"-72"	3/4"	0" - 9"(x2)	2
Two Handed Blunt	40" - 48"	18" - 24"	48"-62"	3/4"	1" - 36"	3
Two Handed Sword	40" - 48"	x	50"-62"	3/4"	1" - 22"	3

Pommel

The pommel is used to protect the butt end of a weapon; it is located at the end of the grip. The pommel should have closed cell foam that extends an inch past the end of the core and is then capped by a piece of closed cell foam.

Weapon Specific Specs

Certain weapons types may have additional requirements, which can be found below.

Bow

The NERO Bow (referred to hereafter as Bow) must be curved and formed in the shape of a bow. Overall length in a straight line from tip to tip must be between 34 and 58 inches. Thrusting tips must be on both ends.

Crossbow

The NERO Crossbow (referred to hereafter as Bow) must be a T-shape, with a stock length of 12 to 24 inches. The cross piece must be at least half the stock length and may not exceed 24 inches. Thrusting tips must be on all ends.

Arrows/Bolts

These are represented by yellow packets. Yellow packets are considered in-game items until they are fired and cannot be held in the same hand as another game item while either item is in use. Arrows are always stoppable by Shields and weapons.

Quiver: An archer needs a Quiver in which they must carry their shots. There are 30 shots (arrows, bolts, etc.) in each quiver. Each time the character shoots his missile weapon whether he hits or

the character shoots his missile weapon whether he hits or misses his target, a single shot is lost from his quiver.

Arrows and other missiles (bolts, etc.) are not recoverable items. Thrown Weapons such as small thrown weapons and javelins are recoverable.

Each quiver physical representation must be able to hold at least 30 yellow packets and, look like a real quiver. Each quiver can hold no more than 30 yellow packets, and a character cannot have tags for more than 30 yellow packets per quiver rep on his person. The archer may carry as many quivers as he wants, as long as he has a physical representation for each.

Daggers/One Handed Swords/Two Handed Swords

Daggers, one handed swords, and two handed swords all follow the same basic construction guidelines. Each sword-type weapon has a blade, crossguard and pommel, and a grip area. There may be no gaps in foam between the top of the grip and the thrusting tip at the end of the blade.

In the case of swords without a perpendicular-style crossguard, such as katana, the blade area may extend from the top of the grip to the thrusting tip.

Maces/Axes/Hammers (Bludgeon/Hatchet/Sap)

There are five main parts to all maces, axes and hammers: the pommel, grip, shaft, head and thrusting tip. With the exception of the head that must be crafted of open cell foam, all styles are the same basic design. Weapons that do not have areas of 1" thick open cell foam, which have pointed edges, or areas that "catch" other weapons may be deemed unacceptable by any marshal. Axes may have a crossguard incorporated into the design. A Bludgeon is a small mace, a Hatchet is a small Axe, and a Sap is a small hammer.

Polearms/Spears

There are five main parts to all polearms and spears: the pommel, grip, shaft, head and thrusting tip. The thrusting tip is often incorporated into the head of polearms in order to reduce the tendency for it to shear off on a swing, and the thrusting tip for a spear should be incorporated into the head of the spear. Spears may only be used for thrusting. Spears and polearms may both have a crossguard incorporated into the design.

Staves

A staff is very simple to make, with whole of the core covered by foam, or you may have two hand holds not covered by foam. A staff must have thrusting tips on both ends. The middle 6" of the staff must be padded with a minimum of 1/2" thick pipe insulation.

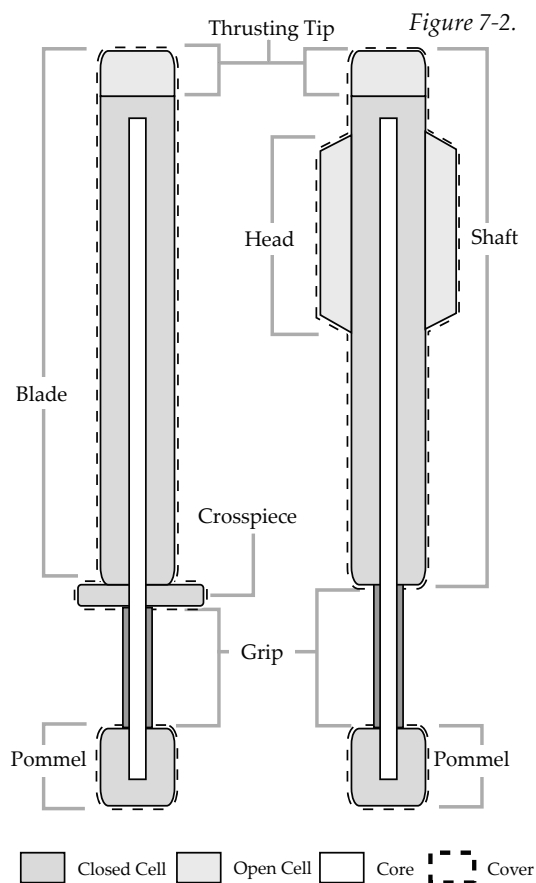

Figure 7-2.

Thrown Weapons

Thrown rocks, throwing stars, thrown daggers, javelins and other thrown weapons may not contain a core of any sort. Rocks must be made of a 6" x 6" or larger piece of open cell foam, and can be covered with duct tape, kite tape or fabric. Throwing stars, daggers or axes may be made of closed cell foam with no core, and should be cut into the appropriate shape, with tips not less than 2" wide. All thrown weapons must be a minimum of 6" long and may be a maximum of 18" long.

A javelin must be made of 3 feet of closed cell pipe foam with thrusting tips at both ends. A javelin may not include a core of any sort.

Thrown weapons may not be used in melee combat, they must be thrown. Since there is a wide range of shapes and sizes that can be used, approval is based on a case by

case basis by the weapons marshal.

Weapon Safety Guidelines

Please see the NERO International Website www.nerolarp.com for the most updated information regarding weapon safety rules.

There are several basic rules regarding weapon construction in NERO and they are as follows:

- ⓐ All weapons must all within the minimum and maximum length, grip and blade requirements for their weapon type.
- ⓑ All weapons must be approved by a NERO safety marshal before they can be used in play.
- ⓒ All home made weapons must have a thrusting tip.
- ⓓ All weapons must be padded from the tip of the blade to the hand grip. All weapons must be padded with at least 5/8 inch wall thickness closed cell foam regardless of blade size.
- ⓔ A weapon must have at least 0.5 inch but no more than 1.5 inches of closed cell foam extending beyond the end of the core before the thrusting tip is added.
- ⓕ All tips must be rendered safe with tape/cloth and padding. In a melee, it is possible to accidentally hit someone with the pommel or cross guard, so these parts must be protected as well.
- ⓖ All blade areas or areas of the weapon that may come in contact with another player must be protected with at least 5/8 inch



PVC CPVC Kitespar Duct Tape Ripstop Nylon



5/8 Pipe foam Pool noodle Camp pad Open cell foam Car Sponge

weapons such as axes, hammers, maces, etc.

- Ⓢ All weapons must be fairly rigid so as not to act as a whip when swung quickly. Under most circumstances, a weapon tip should not bend more than 6 inches from true when moderate force is applied to the tip and the grip is held level. Conversely, all weapons must also have some give to them when contact is made.

Construction Materials

Core

The core is the interior portion of a weapon that gives it strength and rigidity. There are several materials that can be used for cores including various types of PVC piping, some types of spiral wound fiberglass tubing, and several other types of materials. Please note that you may never use wood or heavy metals as part of your core in weapon construction.

The core of the weapon can be made of different materials based on the size of the weapon to be constructed.

Below is an overview of suggested cores and the types of weapons that can be created with each material.

Standard

The standard core for weapons is PVC of which there are 2 types: white PVC used in plumbing and grey PVC or CPVC used for electrical work. The following list uses the inner diameter of the tubing. Please note that schedule 20 CPVC has a thin wall and is more flexible than schedule 40 CPVC. If you use schedule 20, use one size higher based on the weapon you are making.

1/2 inch: This core can be used to make small and short and long weapons. This type of core has more give and should not be used in weapons longer than 46 inches.

3/4 inch: This core can be used to make two handed weapons.

Ultralight

Ultralight cores include carbon fiber, kitespar tube, fiberglass tube, and wrapped graphite tube. Aluminum core may only be used for polearms and staves. These material can be used to make most weapons, however the diameter of the kite pole determines which type of weapon it is best suited for. The following list uses the outer dimension of the tubing.

0.414 inch: This core can be used to make small, short and long weapons. This type of core has more give and should not be used in weapons longer than 46 inches. Please note that depending on the style of weapon construction, this core may have too much give at the maximum length for long weapons.

0.505 inch: This core can be used to make short and long weapons and spears. This type of core has more give and should not be used in weapons longer than 54 inches.

0.610 inch: This core can be used to make staves, two handed weapons and spears. This type of core has more give and should not be used in weapons longer than 64 inches.

0.745 inch: This core can be used for all two handed weapons. This type of core should not be used in weapons shorter than 54 inches.

Closed Cell Foam

This durable water resistant material is used in the construction of weapons in NERO. There are three types of closed cell foam that can be used for weapon construction: Pipe foam insulation, Pool Noodle, and Camp pad.

Pipe foam Insulation: The most common type of closed cell foam is pipe foam insulation. Closed cell pipe foam insulation is used to pad the blades of weapons, and must be at least 5/8 inch wall thickness. Please note that most foam found in home improvement stores does not possess the correct thickness.

Closed cell foam of the appropriate wall thickness can be difficult to locate. Currently the foam is available from a variety of places;

- Ⓢ Merchantswares.com – LARP Gear supply house.
- Ⓢ McMaster-Carr (a commercial tool company) and here is a list of part numbers:
 - Part #4530K161 is usable for .414" kite spar, .505" kite spar and 1/2" PVC.
 - Part #4530K162 is usable for .610" kite spar and 1/2" PVC.
 - Part #4530K163 is usable for .745" kite spar, 3/4" PVC.

Pool noodle: Pool noodle is thicker than pipe insulation, and not all pool noodles fit PVC. You should bring measuring tape or a piece of pipe with you when you buy it.

Camp Pad: This material is used to make more advanced, sculpted weapons. The average camp pad found in stores such as Walmart is 1/4" thick. To achieve the correct thickness you must laminate multiple pieces together with contact cement. Weapons made with



this material are held up to more scrutiny. Visit www.nerolarp.com for specifications for sculpted weapons. You should not attempt to make your first weapon out of this material.

Open Cell Foam:

This material is a less dense foam that is commonly used to stuff couches and pillows and is found in most fabric stores. This foam is used in the construction of thrusting tips, weapon heads and some thrown weapons. The foam should be easily squeezable and not too dense. Alternatively you can also use a car sponge found at hardware stores.

Tapes

There are several types of tape that are commonly used in weapon making:

Duct Tape: Duct tape is the standard type of tape used in weapon making. It can be used for blades, thrusting tips, crossguards, and pommels. Duct tape can be found in a variety of colors and various thicknesses. Certain types of duct tape are heavier and less suitable for weapon construction.

Kite Tape: Kite tape or Nylon rip stop repair tape is a type of tape that is used normally for fixing kites. It is an extremely light form

of tape that can be used in weapon construction. It is available in a variety of colors and can be purchased from a number of kite supply stores.

Strapping Tape: Strapping tape is a tape that has strands that run vertically along the tape. It is used for securing portions of a weapon together. Strapping tape does not rip, break or tear and makes a great light-weight reinforcement for cross guards, anchor points, thrusting tips and seams. Strapping tape is not used to cover a weapon, but is used under the duct tape to hold things together.

Gaffer Tape: This incredibly durable tape is used in stagecraft. It is a very dense strong tape. This type of tape should not be used on any striking surface of a weapon due to its weight and lack of give. It is useful for making sturdy crossguards.

Weapon Sock: This is sewn piece of fabric (that should be water repellent) that can be used to cover the striking surface of a weapon. This is used sometimes instead of taping the blade of a weapon. Ripstop nylon is a good fabric to use for this.

How to Make a Weapon

Constructing a weapon requires time and patience, but it is not that hard once you have practiced a bit. The next section will describe the steps to create various weapons, but focused on a basic one handed edged weapon.

In each of the steps, there will be a description of the materials and techniques.

Tools and materials:

Below is a list of tools and a list of materials you'll need to make most weapons.

Tools

1. Marker
2. Measuring tool
3. Strapping/Duct tape
4. Saw
5. Scissors/Xacto/
Carving knife

Materials

1. Core
2. Closed cel foam
3. Duct tape
4. 2" x 2" x weapon
diameter Open Cel
foam tip(s)

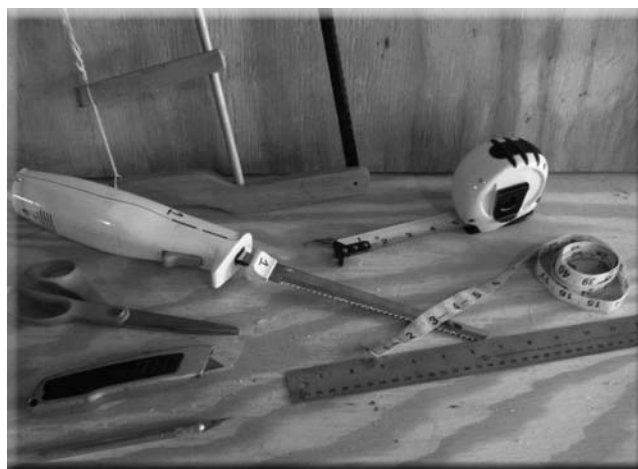

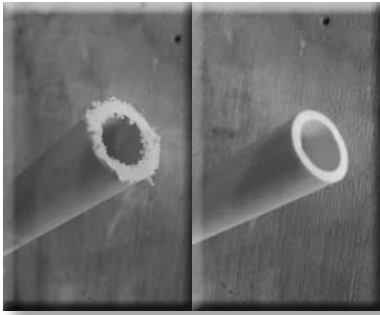

1. The core of the weapon

After gathering your materials, the next step in creating a weapon is selecting an appropriate core for the type of weapon that you wish to make. You will need to do several things to prepare the core for weapon construction. First you will need to determine the length of the weapon that you wish make. Then you will have to cut the core approximately 3 inches shorter than the overall length of the weapon, 5 for weapons that require thrusting tips on both ends. This allows for padding both ends and the thrusting tip(s).

Cut the core to the right length with a hacksaw. If you are using a fibrous material, like kitespar, wrap a piece of tape around the area you are cutting to keep the fibers from fraying. Take care not to score areas that will be on your finished weapons. You will then need to clean up the edges of the cut so that there are no burrs or other protrusions. Lastly, you will need to cover both ends of the core with tape so there are no open ends.

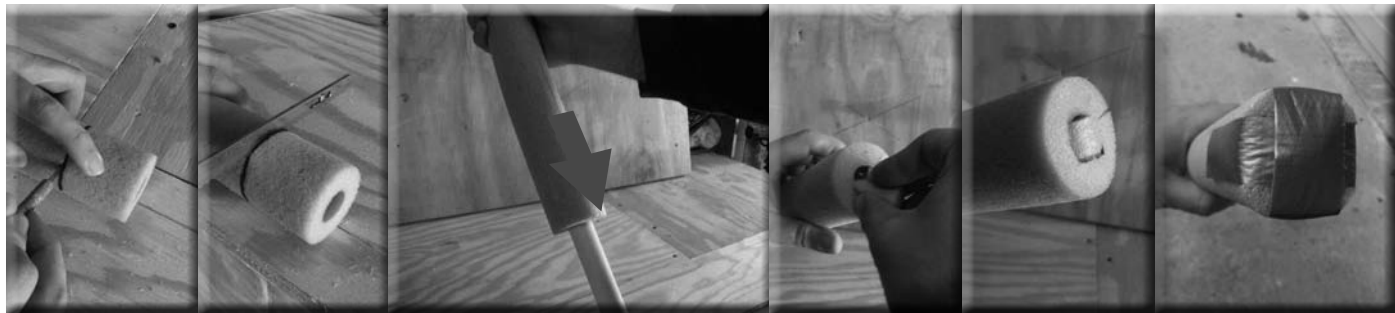

2. Pad the striking area

The next step in creating a weapon is padding the striking area of the weapon. There are several things that you will need to do in this step. First, you should measure and cut the pipe foam to the desired blade/shaft length. Remember to measure the blade length to account for the the thrusting tip and the 1/2" overhang from the core. Next, you should slide the pipe foam over the core so that a 1/2" of foam hangs over one end. Make sure that the foam is snug to the core; if it rattles then the closed cell foam is too large and you will need to build out the core so that foam does not rattle. Cut off 1" of pipe foam (not from the piece you are using for the blade) and cut it into two equal halves. Compress one of the halves and stuff it into the end of the blade foam. Using a piece of tape, cover the small piece of foam that has been put into the end of the blade.

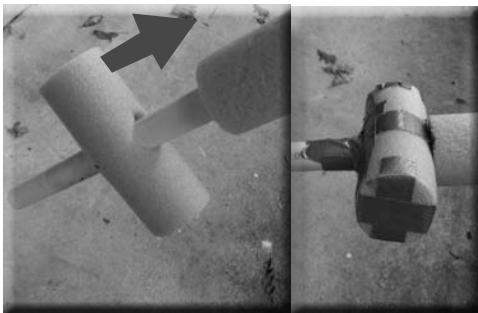

3. Add a crossguard (optional)

The next step is an optional step when creating a weapon though it is strongly encouraged. Certain weapon types have cross guards, including most types of swords and occasionally other hafted weapons. First, you need to cut a section of closed cell pipe foam of the appropriate size. Then cut a hole in the middle of the cross guard foam and slide the crossguard down the core until it meets the blade. Secure the crossguard to the blade using two strips of duct tape, then stuff the ends of the crossguard with open cell foam to strengthen the crossguard. Close off the ends of the crossguard with tape. Secure the cross guard to the grip by taking strips of tape from the crossguard to the grip. This will secure the blade and crossguard to the grip.



4. Add a pommel

The next step is to add a pommel at the end of the weapon. Cut a piece of closed cell foam so that is about 3 inches long. Place the foam on the butt end of the weapon so that the foam hangs at least one inch over the weapon's core. As with the blade tip, place a half circle of compressed closed cell foam into the end of the foam and cover it with tape. Secure the pommel to the core with tape in such a way that at least one inch of closed cell foam extends past the core. Make sure that the pommel is secure to the core and is not loose.

6. Add a thrusting tip

The tip of the striking surface must have a thrusting tip. This tip is 2" of open cell foam. Longer thrusting tips tend to bend. Cut the foam to cover the tip. Once the tip is in place,

use tape to cover it. Take a length of tape and place it so it goes across the end of the tip and down both sides, attaching the tip to the weapon. If the tip is round, use a razor to cut the corners so the tape conforms to the tip. Now add another piece of tape so that it goes across the end and



down the exposed sides of the foam tip. Use a razor to cut the corners so the tape overlaps slightly and conforms to the tip. Finally, poke many tiny holes all over the tip so the air can escape and the tip can contract and expand freely.



7. Cover the blade

The next step is to cover the exposed foam with tape or with a weapon sock. Any striking surface on a weapon should be covered with either a weapon sock or tape. If you choose to use tape, all of the tape on the striking surface of a weapon should run vertically from

the thrusting tip to the pommel and should slightly overlap the piece next to it. Do not use overuse tape on striking surfaces and thrusting tips, one layer with slight overlap is enough. Excessive layering may make your weapon hard and un-passable. Tape should NEVER be spiral wrapped around the weapon.



8. Add a grip

The last step of the weapon making process is to cover the exposed grip with tape so that it is easy to wield. Use electrical tape or hockey grip tape spiral wrapped around the grip section of the weapon, so that it can be held easily. If the weapon

is not thick enough to comfortably wield, you may use padding beneath the grip tape.

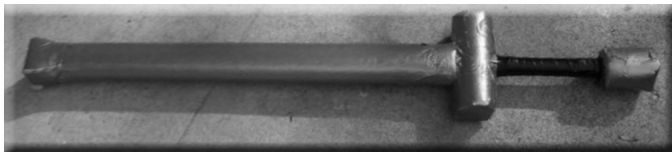

Maintaining Your NERO Weapon

Any latex foam or boffer swords must be stored and maintained properly in order to remain safe. There are a few simple things you can do to increase the longevity of your weapon.

- Ⓜ Do not store foam weapons in extreme heat or cold for any length

of time. Storing it in your car in the sun may cause paints to stick, tape to wrinkle and general degradation of the weapon over time.

- Ⓜ Avoid soaking weapons in water and do not use your weapons if they have become waterlogged.
- Ⓜ Do not rest weapons on the tips, lean on the foam ends or otherwise mash the foam at the ends. The tip foam will break down leaving less padding on the core, which will lead to failure of weapons safety check.
- Ⓜ You may want to consider a fabric bag for individual latex weapons to keep their finish protected while in storage.

Shields

Safety is the prime consideration when constructing a shield.

You may use almost any strong material such as wood, plastic or aluminum, but all edges must be covered with 5/8" pipe insulation. The face and edges of your shield may not have any sharp edges, bolts or other protuberances that would potentially cut or otherwise injure another person.

The longest dimension of a shield may not exceed 36 inches, including the pipe foam that covers the edges. The maximum area of a shield is 531 square inches (a 26" diameter circle). The area of a shield includes any cavities, recesses, voids or holes in the shield. A shield may be made in any shape, be it circular, oval, "kite" or "coffin" shaped, teardrop shaped or make to another design.

The parts of a shield consist of the face, padded edging, and handle. Corrugated plastic, round sled blanks or wood are inexpensive and easy to cut to your preferred shape. You can obtain a handle from almost any hardware store, and then use a 1" to 1 1/2" strip of nylon strapping, or part of a belt to make the strap that will hold the shield to your forearm.

Take care to attach the handle and strap in a manner that does not leave sharp bolts or edges on the outside of your shield and trim any edges on the inside that may cut the shield user. While a shield may not be used offensively at NERO, and may not be used for "shield bashing", it is possible that you could trip or fall on your shield, or someone else could fall into you. Safety is important, and any shield not considered safe by a weapons marshal will be failed at safety check.

Potions

The effects of potions and scrolls are the same as for a cast spell.

A scroll or potion physical representation is not valid unless it has an actual scroll or potion tag attached to the phys-rep. Likewise, a scroll or potion tag without a physical representation is also invalid. If you receive tags without physical representations (for example, after using your Production Points to create items), then it is your responsibility to provide the appropriate physical representation and make sure the tag is attached.

All potion phys-reps must be large enough to hold, or appear to hold, at least a minimum of a quarter ounce of liquid. The phys-rep does not actually have to contain any liquid to be valid.

When the potion is used, the "used" potion tag must be given to

Figure 7-3.

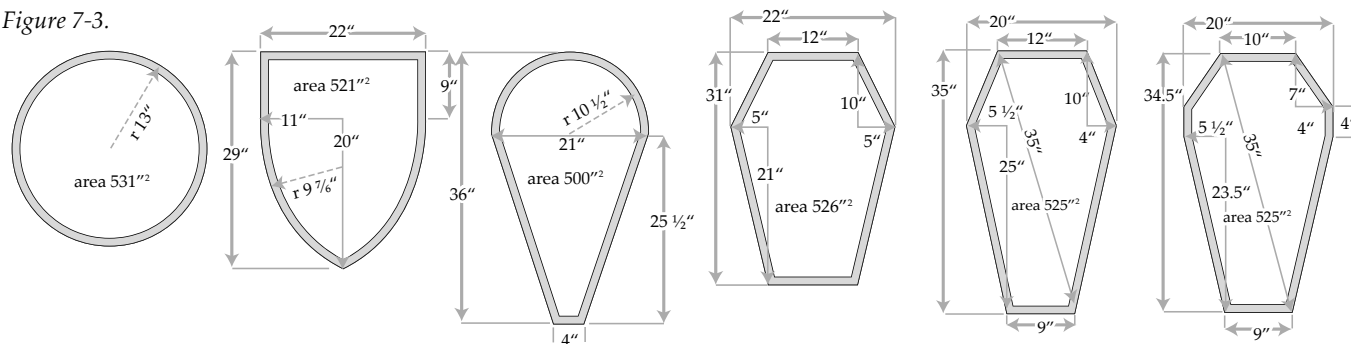

the recipient or a Marshal as appropriate.

To use a potion, you must role-play the proper drinking motions, and this must take at least three seconds. You do not have to count it out loud.

A potion may be “force fed” to an unconscious or sleeping person by someone else, but such a character cannot “accidentally” drink one. You cannot attach a potion or elixir to your collar or shield and “bite” into it to get its effects while bound or in battle.

Potions cannot be mixed into food or drink or diluted or mixed together in any way. All potions affect the drinker only, and bypass any protective spells such as *SHIELD MAGIC* or *REFLECT MAGIC*. Note that potions affect only the drinker and do not give the drinker the ability to cast the spell effect of the particular potion. For example, a person drinking a *DISPEL MAGIC* potion does not gain the ability to cast a *DISPEL MAGIC* instead, the potion will dispel all magic on the drinker.

Scrolls

To use a scroll, you must pull out the scroll, hold it before you, have enough light to be able to read it, touch a spell packet to the scroll, actually read the scroll, and then throw the packet. If your scroll is attached to a weapon or shield, you may not be swinging it while reading the scroll.

After the scroll is used, the tag is removed but the paper remains. The magical writing is inert although anyone can tell what spell used to be on the scroll. You must have an actual scroll phys-rep for each scroll tag.

All scroll phys-reps must be at least 16 square inches (For example, a scroll that is 2 inches tall by 8 inches long would be fine).

Alchemy

Players with the skill of Alchemy can create certain contact substances, elixirs and gases. These substance do not detect as magical by *DETECT MAGIC*. Alchemical effects are not affected by *DISPEL MAGIC*.

Anyone can drink an elixir or feed one to someone else or apply *VORPAL COATINGS*. To apply other poisons you need one level of Alchemy. To throw gas globes you must have the same number of alchemy levels as the gas’ production level. In essence you must be able to make a gas to throw it.

Creating Alchemical Substances

Alchemy is a production skill and is governed by the Production

system as described in *The skill System* chapter page 33. You may make any alchemical substance that you possess the skill to make that has a cost in the Production Levels chart.

Damage from Alchemy

Characters can be affected by alchemical substances in many ways. The effects are instantaneous. “Cause” poisons do body damage only, since they bypass armor. This damage can not be reversed by an antidote, but can be healed as normal damage.

BERSERK, *FEEBLEMIND*, *HALLUCINOID*, *NAUSEA*, *PARALYZE*, *SLEEP*, and *VERTIGO* are all visible to any viewer while they are in effect, so long as they take the time to observe them and ask the affected player “Visible Effects?” and the affected player will respond “Visibly <effect>ed”. Many substances can be reversed by a specific antidote if taken after exposure to the substance. The spell defensive *POISON SHIELD* will not stop ingested substances from taking effect, but will stop all other attacks with the word “poison” in the verbal. The spell *PURIFY BLOOD* will cleanse the body of all active poison effects present except for *ENSLAVEMENT*. *ALCHEMICAL SOLVENTS*, *VORPAL COATINGS*, *LIQUID LIGHTS*, *PASTES OF STICKINESS*, and *OILS OF SLIPPERINESS* are not affected by *PURIFY BLOOD* and will not set off a *POISON SHIELD* or a *RESIST POISON*.

Mind Effect Restrictions

A chapter may, at their option, restrict the use of the following effects: *ENSLAVEMENT*, *FORGET-IT-WELL*, and *FORGET-ME-NOT*. The chapter may restrict these effects in one of two ways. They can choose these effects to be void and unusable in their chapter, or they may opt to allow their usage only against NPCs.

Information on whether your local chapter uses the Mind Effect Restrictions rule, and which Game Effects this rule applies to will be available on the chapter’s Web site, and will also be announced at the Opening Ceremonies of all of their events.

Types of Alchemical Substances

Elixirs

Elixirs may be drunk like potions or they may be placed in food or drink. This is signified by either attaching the tag to the underside of the food vessel, placing a token in the food, or having a marshal witness you make pouring motions over the food or drink. Mixing two elixirs does not cancel the elixirs. If a food or drink has more than one elixir present, all elixirs will affect the victim and be used up after the first bite or drink. One use of the racial skill *RESIST POISON* will block all elixirs present.

Alchemy Table 7-8.

EFFECT			
Alchemical Solvent	2		
Antidote (Contact)		2	
Antidote (Gas)		4	
Antidote (Ingested)		5	
Berserk		10	
Cause Damage		2	3
Cause Light Damage		1	2
Cause Serious Damage		4	5
Charm			8
Cure Light Damage		1	
Death		9	
Enslavement Antidote		10	
Feeblemind		6	7
Forget-it-Well		10	
Forget-Me-Not		7	
Hallucinoid		2	
Intoxicant		1	
Liquid Light	1		
Nausea		5	6
Oil of Slipperiness	5		
Paralyze		8	9
Paranoia		2	3
Paste of Stickiness	5		
Poison Shield		4	
Sleep		6	7
Vertigo		5	6
Vorpal Coating 1	1		
Vorpal Coating 3	3		
Vorpal Coating 5	5		
Weakness		3	4

Gases

Gases are delivered by an orange packet. Unlike a spell packet, gas containers are in-game. They work on a single target, indoors or outdoors. Before throwing the packet, the user must announce “<Type> gas poison;” for example “Sleep gas poison.” This phrase simulates preparing the gas. The “verbal” is not in-game so even a silenced or mute character may use one. If the “verbal” is not said properly then the attack is unsuccessful as the gas was not “prepared” properly (Imagine preparing a hand grenade). The packet must hit the target or the target’s possessions and otherwise must follow all spell packet rules. Even though the “verbal” is not in-game, the effect is recognized by anyone who hears it. (In-game, assume each gas has a different color and texture associated with it to allow for identification.) If the poison does numerical damage, the number is added to the end of the “verbal” and must

Figure 7-4.

Contact: 
Elixir: 
Gas: 

be said before the packet is thrown. Thrown Alchemy is subject to Disruption.

Note that gas globes, since they are in-game, can be fumbled and stolen. To steal a globe, you must steal the actual globe physical representation itself and not the tag. You may then either go out-of-game to the person from whom you stole the globes in order to get the tags, or can get a Marshal to do it.

Gases can also be put into gas traps. See “Gas Traps” on page 97.

Contact poisons

Contact poisons must be represented by a gel-like substance that can be smeared on the object to be trapped. (Petroleum jelly works fine). If the person applying the substance comes in contact with it, he or she will be affected as well (if applicable). *POISON SHIELD* and *RESIST POISON* will protect the victim from being affected by contact poisons. Multiple contact poisons which would normally affect a victim simultaneously are protected by a single *POISON SHIELD* or *RESIST POISON*.

Vorpal Coatings

VORPAL COATINGS add 5 points to the base damage of the weapon, for a set number of hits per application. They take effect immediately, doing damage to Armor Points and then Body Points after all Armor Points have been removed.

Damage should be called by adding 5 points to the weapon damage (with any other magical or skill bonuses also added, of course).

A hit is used up only if the strike lands or it is negated by a defense, but cannot be saved up to use on later swings once applied; the damage increase is for the first 1, 3, or 5 hits depending on the coating used.

Applying a *VORPAL COATING* takes time to apply. It cannot be done with a quick touch in the middle of battle. The tag must be taped onto the weapon. The taping of the tag onto the weapon represents the time it takes, which may never be less than three seconds. If you do not have the tag taped to your weapon then the *VORPAL COATING* is not effective. A new tag must be put on the weapon each time a new *VORPAL COATING* is applied. Only one vorpal coating can be on a weapon at a time.

Alchemical Substances

Alchemical Solvent

Level: 2 Duration: Instant

This solvent, covering one square foot per dose, will remove either an *OIL OF SLIPPERINESS* or a *PASTE OF STICKINESS*. Once used, the entire dosage is consumed.

Antidote

Level: 2/4/5 Duration: Instant

Antidotes are used to cure lasting effects, such as from *SLEEP* elixirs and not from instantaneous effects such as damage.

ANTIDOTE (CONTACT) cures any contact substance. *ANTIDOTE (INGESTED)* cures any ingested elixir. *ANTIDOTE (GAS)* cures any gas substance. It does not remove any monster carrier attacks. Gas Antidote will remove Monster Packet attacks only if the attack included the word "Gas". *ENSLAVEMENT* needs a specific antidote.

Berserk

Level: 10 Duration: 5 Minutes

This will drive the victim into an insane killing fury, causing the victim to attack all creatures in the vicinity to the best of its ability.

Cause Damage

Level: 2 (Gas: 3) Duration: Instant

This substance does 10 points of body damage.

Cause Light Damage

Level: 1 (Gas: 2) Duration: Instant

This substance does 5 points of body damage.

Cause Serious Damage

Level: 4 (Gas: 5) Duration: Instant

This substance does 20 points of body damage.

Charm

Level: 8 Duration: 5 Minutes

This alchemical substance will cause the victim to be under the same effects as a Charm spell. The victim will be Charmed to the creature who administered the poison. It can be resisted by those with a *RESIST CHARM* ability.

Cure Light Damage

Level: 1 Duration: Instant

This substance heals 5 points of body damage.

Death

Level: 9 Duration: Instant

This causes death immediately, see *Table 2-2 on page 23*. This elixir does not leave any traceable marks, and cannot be identified as the cause of death. The only thing that will save the victim of this poison is a *LIFE* spell given within five minutes.

Enslavement

Duration: Indefinite

The victim of this poison will be enslaved to the person administering the poison and will obey absolutely any and all commands given

by the person to whom they are enslaved, and will even commit suicide. Otherwise, it has the same effects as a *CHARM* spell.

ENSLAVEMENT can only be cured by a specific antidote. This effect is also removed if the character resurrects. This effect is stronger than *CALM*, *CALM ANIMAL*, *CHARM*, *CHARM ANIMAL*, *SHUN*, *SHUN ANIMAL*, *CONTROL UNDEAD*, or *FEAR*. See *Table 5-6 on page 64*.

Please note that additional *ENSLAVEMENT* effects will override another *ENSLAVEMENT* effect, see "*Charm Effects*" on page 47.

ENSLAVEMENT is a powerful ability which particularly has the potential to ruin the fun of any player. As such the use of this effect can never be used by a PC on a PC.

No other effect (either LCO or otherwise) may duplicate the ability of Enslavement.

In addition, the following rules apply to Enslavement:

- ⓐ You cannot administer Enslavement to yourself.
- ⓑ You cannot be enslaved to "act normally," However a person under the effects of enslavement does not act like a robot or strangely, they are just compelled to follow the wishes of the enslaver.
- ⓒ The duration of Enslavement is permanent, and it can only be cured by the specific antidote or the resurrection of the target.

Enslavement Antidote

Level: 10 Duration: Instant

This antidote is the only thing that will release a victim from the effects of an Enslavement poison. After the Enslavement is cured, the victim remembers everything that happened and knows they were enslaved and to whom.

Feeblemind

Level: 6 (Gas: 7) Duration: 5 Minutes

This alchemical substance lowers a character's intelligence to that of an idiot for 5 minutes. While under its effects, a character cannot use any skills and is so stupid that he or she is not even aware of the poisoning.

Forget-It-Well

Level: 10 Duration: Indefinite

This poison will cause the victim to forget everything that happened within the last hour. This amnesia becomes permanent if not cured within ten minutes by a *PURIFY BLOOD* spell or the appropriate antidote. A Killing Blow within the ten minutes will not reverse the memory loss effect of this poison, and neither will resurrection, but if the victim's body dissipates before the 10 minute period has elapsed, then the poison will be negated and the memories restored.

Forget-it poisons, like all poisons, may never be used on a creature that is dead.

Forget-Me-Not

Level: 7 Duration: Indefinite

This alchemical substance will cause the victim to lose memory of the last 15 minutes. In every other way it acts the same as a *FORGET-IT-WELL*.

Hallucinoid

Level: 2 Duration: 5 Minutes

This alchemical substance causes the victim to hallucinate. They will see pink elephants and other strange things for 5 minutes. The victim will probably be aware that they are under the effects of a poison but will be unable to do much about it. When under its effects, game skills can be used, but the player will most likely use them against imaginary creatures.

Intoxicant

Level: 1 Duration: 1 Hour

This acts as a strong alcoholic drink. It will render the victim quite drunk for 1 hour.

Liquid Light

Level: 1 Duration: 5 Days

This substance will allow a glow stick or other light physical representation to be used in game as per the Illumination spell. It cannot be applied to a tree or other object to make it glow; it can only be used on a phys-rep that gives off light. Please note that Alchemy 1 is required to activate a LIQUID LIGHT, but not to hold, or otherwise use one, once it has been activated.

Nausea

Level: 5 (Gas: 6) Duration: 5 Minutes

This elixir will cause the victim to be nauseous for five minutes, during which time no in game skills can be used.

Oil of Slipperiness

Level: 5 Duration: 1 hour

This is a contact oil that will last for one hour once exposed to air. If put on an item, the oil will make the item impossible to pick up. It could also be placed on the ground (if enough were used) to prevent anyone from standing in the area. You would not be able to even crawl out of the area unless you could grab a hold onto something or someone outside of the area to pull free. One dose will cover an object up to one square foot in area. It can be counteracted by an

ALCHEMICAL SOLVENT or a PASTE OF STICKINESS.

Paralyze

Level: 8 (Gas: 9) Duration: 5 Minutes

This poison is identical to a PARALYZE spell.

Paranoia

Level: 2 (Gas: 3) Duration: 5 Minutes

This causes the victim to think that people he or she normally dislikes are out to kill them. It lasts one hour.

Paste of Stickiness

Level: 5 Duration: 1 Hour

This paste acts as a glue that lasts an hour once exposed to air. One dose covers one square inch of a surface. It can be used to stick things to someone so they cannot be removed until the hour runs out.

It can also be used to pin people to the ground if enough is available. Note that this paste will have no effect in combat as it takes three seconds to set; thus you cannot put it on your shield or sword to "capture" enemy weapons. It can be counteracted by an ALCHEMICAL SOLVENT, an OIL OF SLIPPERINESS, or a RELEASE spell.

Poison Shield

Level: 4 Duration: Indefinite

This elixir works exactly as the spell of the same name. It grants a Spell Defense to the recipient. It cannot be stacked with the spell of the same name, nor can it be removed by PURIFY BLOOD.

Sleep

Level: 6 (Gas: 7) Duration: 5 Minutes

This poison acts as a SLEEP spell.

Vertigo

Level: 5 (Gas: 6) Duration: 5 Minutes

This poison will cause the victim to lose balance and be unable to remain standing for five minutes, during which the victim can not use any in-game skills.

Vorpal Coating

Level: 1/3/5 Duration: Indefinite

Putting this contact gel on a weapon makes the weapon do 5 extra points of damage for a set number of hits. It comes in three variations: 1 hit Vorpal Coating, 3 hit Vorpal Coating, and 5 hit Vorpal Coating.

Weakness

Level: 3 (Gas: 4) Duration: 5 Minutes

This poison works as the spell of the same name.

atmosphere



Role-playing



ole-playing requires you to create a new persona. You should try to think, feel, move and act like your character. (Keep in mind as you read this that you are the *player*; the persona you adopt is the character.)

It is up to you to decide what your character will say and how your character will act. Imagine yourself actually being the character you have created, and act as your character would. NERO is a fantasy role-playing game, based in a pseudo-medieval era.

character" you, as the player, bear full responsibility for the effects it has on the other players. After all, you created your character in the first place. Be sure to read "Code of Conduct" on page 100 for more guidelines.

This concept also applies to such things as character insanity (temporary or otherwise) as an excuse for crimes. If you feel your character would snap for some reason, feel free to do so; however, you must be willing to have your character face the consequences or be able to fast-talk your way out of the situation.

The atmosphere of our game depends on the players staying in



Your character is living in a world with swords, sorcery, monsters, and magic; act accordingly.

You may design a character that is like yourself or you can be someone totally unlike yourself, and develop a new perspective on the world. You can create a character that does things you would like to do, but can never work up the nerve to try. You can be a fierce warrior, a sneaky thief, or a crafty mage.

Many people are more comfortable creating a character that is more like themselves. Others prefer to play a persona completely opposite. You can do whatever you want (within the rules, of course).

Please remember to be considerate of the other players. Abusing other characters could be going too far, even if it makes sense for your character concept. Remember that even if an action is "in

character. This means talking and thinking only as your character would. Avoid discussions of modern day events and topics. If your character cannot read, then do not read anything. If your character has never seen the local nobility, then you shouldn't recognize them. Do what your character would do. With everyone doing their best to support the atmosphere, you will be surprised at how easy it becomes to stay in your character persona with just a bit of initial effort.

Darkvision & Low-Light vision

There is no such thing as Darkvision or Low-Light vision in the NERO world. Elves, Dwarves, Hobblings and the like do not get any special visual ability.

Whatever you the player can see is what your character can see.

Languages

If you wish to be able to speak another language in character, then you must actually learn it! When you wish to talk in the other language, then you must talk in the other language! This is to prevent someone from overhearing you talk in English pretending that it is another language only to have you say “You didn’t understand that; it’s in another language.”

You do not have to spend any Build Points to learn another language—you just have to find someone who knows the language and then learn it. Keep in mind that in the NERO world, all PC races speak a common language (represented with English) and any other languages associated with those races are dead languages similar to Latin in the modern world.

This concept also applies to such things as character insanity (temporary or otherwise) as an excuse for crimes. If you feel your character would snap for some reason, feel free to do so, but you must be willing to have your character face the consequences or be able to fast-talk your way out of the situation.

The atmosphere of our game depends on the players staying in character. This means talking and thinking only as your character would. Avoid discussions of modern day events and topics. If your character cannot read, then do not read anything. If your character has never seen the local nobility, then you shouldn’t recognize them. Do what your character would do. With everyone doing their best to support the atmosphere, you will be surprised at how easy it becomes to stay in your character persona with just a bit of initial effort.

Costumes

A costume is an easy way to help you establish the personality of your character and to stay “in character.” Once you look the part, it doesn’t take much to become the part. You can create a simple costume for very little money, and can slowly add to it until you have a costume of which you can be proud.

Your costume need not be elaborate. A simple tabard or tunic with a pair of pants (even sweatpants) or a long skirt will be enough to help you play the role. A long shirt belted around the waist works fine. The selection of costume pieces also helps you to define your character’s likes and dislikes.

Your costume should be practical as well as adding to the atmosphere. Make sure you can wear it for long periods in the outdoors. If you plan on doing a lot of fighting and running around in the woods, you probably shouldn’t wear a silk shirt.

Washable fabrics are best as your costume will see some heavy use. Try to avoid any obvious anachronisms such as zippers, Velcro, jeans, baseball caps, printed t-shirts, watches, and sneakers. Eyeglasses are all right (and have in fact been around since the 13th century).



Minimum Costuming Requirements: You must make at least an attempt at a costume. If other players see you walking around dressed in jeans and a t-shirt, wearing a baseball cap and carrying a sword, they will probably assume you are not in-game and will ignore you. Marshals will warn you and tell you that you are not in-game. Quite often, there are merchants at NERO events who will sell pre-made costumes or custom-make costumes for you.

Please do not use crosses, pentacles, and other similar religious symbols. NERO tries not to insult anyone’s religious beliefs and we do not wish to do so accidentally. Personal religious symbols are acceptable, but should not be displayed.

Disguises

You are not allowed to disguise your character using any sort of makeup to change your appearance, since makeup is the only way that NERO players can represent another race or physical characteristics that the players themselves do not have. If you wish to have your character travel incognito, you must use costume and mannerisms.

After all, if the world of Tyrra really existed and there really were Elves and Orcs and Hobblings, you would be able to easily distinguish between a real Dark Elf and someone disguised as a Dark Elf wearing fake ears and face paint.

Certain distinguishing characteristics of a race can never be changed. If you are a Barbarian, you must dress in furs and leathers and talk in a barbaric fashion. If you are a Biata, you can’t shave off your eyebrows. If you are a Gypsy, you must speak with a Gypsy accent.

You are allowed to disguise yourself in limited ways — for example, an Elf can wear a hat to hide his ears or a Drae can wear a hood to cover her face. You can wear a mask over your face, provided it is a Zorro-type of mask and not a monster mask.

Even with these changes, if you are asked out-of-game if you look like your character, you must answer yes so that other players will not think that you are playing an NPC.

Taking Damage

When your character is involved in combat, you should role-play the damage you take! React to the axe cut in your thigh. Say “ouch!” when you take a hit. If someone does enough damage to kill you, then fall down and die. This adds greatly to the enjoyment of the game for all. Just standing there saying “Well, I guess I’m dead” is unimaginative and detracts from the feel everyone is trying to generate of life in another place. Don’t overact the scene, just grunt and fall. Go ahead and stagger a little to avoid landing on a boulder.

Magical Effects

In fantasy games, magic exists, and can have devastating effects. You should treat the magic in NERO the same way your character should act accordingly. If you get hit with a Lightning Bolt spell, then act as if you have been hit with a bolt of lightning! This adds to the atmosphere of the game.

Playing Fair

The NERO® Game System© relies on honesty, and as such, a dishonest player will find it a simple matter to cheat. NERO has set out to design a game that can work without constant supervision. This can be a great asset in terms of ease of play and flexibility, but it has a trade-off in potential abuse. If you cheat, other players will find out eventually, and then no one will want to interact with you. If you do not count hits against you, then soon those you face will stop counting your hits against them.

When word of a cheater's actions gets back to NERO—and it will—then we will remove the offending player from the game, pending investigation.

If someone seems to have extraordinary powers, or you suspect they are confused about their skills or are cheating then you should calmly approach a marshal with your concerns at a later time.

Marshals

Marshals in our game are identified at the start of each event during Opening Ceremonies. They may also carry identification cards. If you have a rules question, need an official to witness an action, or have any other problem, you may ask one of the Marshals.

Anachronisms

Some anachronisms cannot be avoided. However, NERO makes every attempt to avoid modern trappings whenever possible. Please—no Snoopy shields, smiley face banners or other silliness (and keep the Monty Python bits to a minimum). Do not use cell phones, and keep your soda cans and candy wrappers in your cabin!

Gadgets

You are not allowed to use modern electronic gadgetry such as infrared seeing devices, electronic listening devices, or any other technological anachronistic mechanism. In effect, by using these things, it's as if you have a powerful magical item and it would hardly be fair to the rest of the players.

Justifying Anachronisms

In order for the NERO world of Tyrra to function more smoothly, we have allowed certain anachronisms to exist in our medieval society.

Eyeglasses

Although eyeglasses did exist in medieval times, they were not available to most people and were bulky and easily broken. On

Tyrra, many people wear glasses. For safety reasons you are never allowed to remove a player's glasses in order to handicap that person.

Matches

Matches exist in the world of NERO so that you do not have to bring flint and tinder with you everywhere. (If you wish to bring flint and tinder with you to add to the atmosphere of the game, then we will be very happy.) Try to avoid using lighters, but if nothing else is available, they can be used to represent flint and steel.



Bathrooms

The showers and toilets are out of game for safety and privacy purposes, but characters can make references to them as they actually exist—after all, the ancient Romans had indoor plumbing long before the middle ages began. In the world of NERO, only the very richest homes and inns have indoor plumbing. One nice thing about Tyrra as opposed to medieval Earth is that people on Tyrra bathe more often.

Clocks and Watches

Clocks exist in our game but they are very expensive! Perhaps there is one clock per town, probably placed in a high tower. Clocks operate through a series of levers and springs—no electricity of course.

Timepieces include all clocks, watches and small winding pocket watches as well.

Timepieces, if brought by a player, can be used when on a timed module.

Time

In the world of NERO, time passes in-game at the same rate as it does out-of-game. If a month has passed between NERO events, then a month has passed in the world of Tyrra.

To figure out the NERO year, simply remove the first two digits of the current mundane year and replace them with a "6" so that 2005 becomes 605. This in no way is meant to imply that our games take place in a world similar to Earth's seventh century.

Discrimination

What NERO is attempting to do is create the days of legend as we would have liked them to be, not as they really were. That means our culture is considerably more egalitarian than a real

medieval society. No discrimination is allowed against players in a NERO game. You cannot be denied a position as a noble, a member of the army or any other NERO-sponsored group on the basis of race, religion, gender, age, sexual orientation, or country of origin. However, this does not mean that the world of NERO is an egalitarian paradise. There are countries and people who do discriminate in-game.

Although you the player are not allowed to discriminate, your character can discriminate on the in-game basis of matters of players' choice.

For example, Kildor the fighter hates all dwarves. He thinks they are the lowest form of life (no pun intended) and he kills them whenever he gets the chance. Players who have dwarven characters that are killed by him cannot claim that they are being discriminated against because they chose to play dwarf characters.

It is very important that all players try to distinguish between in-game prejudices and out-of-game prejudices. It is better to steer clear of the issue altogether if possible.

Science

How advanced is science in NERO? Well, scholars are aware that the planet Tyrra is not the center of the solar system and that the world is not flat. They are also aware of the existence of real elements (as opposed to the 'traditional' magical elements of Earth, Air, Water and Fire) and there is even a Periodic Table of the Elements which lists all twelve elements known. Lenses for glasses and telescopes are in existence but are generally of poor quality. There are compasses and navigational materials for traveling but PC's aren't allowed to bring and use them.

Scientific evolution on Tyrra has been stunted by the prevalence of magic. Tyrran science is right at the verge of the Renaissance, on the tail end of the Dark Ages, where astrology and magic are considered scientific facts.

Consider NERO's science to be right at the verge of the renaissance, on the tail end of the Dark Ages.

Magic

Although magicians, can perform all sorts of amazing feats, we have to limit them because of real world difficulties. For example, we do not have an invisibility spell because it is almost impossible to pretend you "don't see" someone. We also have no flying spells, growing spells, polymorph spells or any other unusual spells that cannot be performed or easily imagined out-of-game.

We once had a Scry spell (now available in very limited quantities as an Interplanar Conduit formal magic) which was removed for its unplayability—we could not answer questions that the spell would have been able to answer ("Where did I put my hat?" "Where will the Baron be tomorrow at 2 p.m.?" "Who in town is thinking about killing me?")

A Truth spell was also removed for much the same reason—how can we force players

(not characters) to tell the truth? And (metaphysically speaking) what is truth, anyway? No effect can force a PC to tell the truth.

Healing

Why need anyone ever suffer if there are healing spells? Well, the answer is that healing spells cannot do everything. If you are damaged (or dead) and you are then magically healed to your maximum (or resurrected), then you are returned to the state your body was in before the damage was taken. If you had a limp before you were healed, you still have a limp. If you were dying of old age, then you are still dying of old age. How do we explain limps, handicaps, and scars? One explanation is that it's all psychological. If you were injured long ago and healed naturally, gaining a scar, then you are psychologically aware of the scar and when resurrected, it will still be there because your mind accepts you that way.

Another explanation is that the spells or resurrection heals you up to the state you were in last before you took any recent damage. In other words, if your body healed normally after a battle and you ended up with scars, any future healing would not correct that old injury. You can decide which of these two in-game explanations works for you.

A Cure Disease spell will only cure magically caused diseases. It will not cure cancer, get rid of athlete's feet, or hide your bald spot. This gives some players fun at role-playing frustrations of being sick: "You mean they can bring me back to life after dying but they can't cure the common cold?!"

Religion

Although religion played a very large part in medieval society, we do not allow it in-game because we do not wish to accidentally insult anyone's beliefs. Please do not prominently display any religious symbols or use them in your costume design nor use any religious title in your character's name. Always avoid references to gods or demons or religious rituals.



Words and Language

Although technically the characters in the world of NERO are speaking some unusual fantasy language, we have thoughtfully translated these words into English for you.

Although it would be fun to have fantasy names for the months, days of the week, planets and other common things, it would be very confusing to play the game that way—especially for players who only attend an event or two a year. Therefore, we stick with the traditional words used in modern English.

We do not use the old English "thee" or "thou" or other Shakespearian era vocabulary. In game, we state that we once used terminology like that but language has evolved. You may note that certain old documents such as the Code of Chivalry may still be written in that style. There may

also be some countries or cultures where it is still used.

Foreign and racial in-game languages exist in NERO but you must actually learn them. See the section on “Languages” in the chapter on Miscellaneous Rules for more information.

The Society of NERO

NERO games take place on the planet known as “Tyrra” in most languages. Coincidentally, it is a planet not unlike Earth in climate and topography! NERO is trying to create and represent a fantasy world, based primarily on medieval Europe. This is not to say that your character should be limited by this; you may choose to play a character based on medieval China or ancient Egypt.

Government

Our present-day concept of democracy is a very foreign idea to Tyrrans. There may be some countries that have a very limited form of democracy—for example, all the nobles can vote on certain issues—but that is the extent of it. Even peasants who revolt against unfair kings never think to replace the kingdom with democracy, but only with a fairer monarch or other ruling elite. Here’s how it works:

The kingdom functions as a feudal society. This means that there is a strongly observed hierarchy. It is not a system of equality of all people. It is a system of duty to one’s superior in return for protection and support.

The king owns all of the lands and properties within the kingdom. The king chooses people to administer the majority of these holdings in his name. These people are vassals of the king. Each of these people administer the land as if they were their own and in return they swear that they will support the king, provide troops in time of war, collect taxes, and meet any other duties the king expects of them. These vassals are called dukes. In turn each of these people appoints vassals of their own, called counts and barons. Again, Oaths of Fealty bind the duke with his vassals. Further, counts and barons may assign areas of land to vassals of their own, called knights and lords.

Every person in the preceding group is collectively known as a “noble.” Any person who is not a noble is a commoner. They are the fiber of society, performing the day to day work. They are the farmers, craftsman, healers, soldiers, fisherman, and etcetera. Just because they are commoners does not mean that they are cattle to be controlled by nobles. Somewhere between the nobles and the commoners are the adventurers. Adventurers get respect because of their deeds and the fact that they usually have a bit of money.

Since NERO is an epic fantasy game, most of our players are nobles or adventurers, not commoners. Although a real medieval society would have many commoners tending fields, cleaning stables, and doing the other day to day menial tasks that must be performed, no player wants to play such a role. For game purposes, assume they are out there somewhere. Every once in a while you might meet a few NPCs playing these parts who have information for you.

Each noble owes certain responsibilities to commoners upon their lands. In return for part of the profits of the commoners’ labors, the noble who governs the land is expected to protect them from crime,

invasion, and help them when they need it. The noble is expected to provide leadership, an example of proper behavior, and to improve the lot of his or her peasants over time.

The commoners’ responsibility is to be willing to pay fair taxes, join the militia in time of need, help their lord administer justice by reporting crimes and providing testimony, defend their lord’s name, and address and treat nobles with the respect they are due.

Societal Conventions

These “laws” form the basic customs of the people and are followed by all members of the society, from the highest noble to the lowest peasant. These laws are so ingrained in the society that they are rarely challenged. Anyone found to have violated these laws should be shunned by all as a villain and an untrustworthy social deviant.

Hospitality: Any person who is invited into your home or holdings and accepts your hospitality will be treated as a guest with the respect due a person of their class and station. This person will be protected from all harm by you and all members of your household. By accepting your hospitality, the guest also agrees to give respect where it is due and not take advantage of your goodwill.

Loyalty: Any person who swears fealty to you as their liege will obey you and be loyal to you and in turn you will support them and





give them your protection.

Kinship: Any member of your family must be loyal to you and you must be loyal to them. Because they are family they are worthy of your trust.

Honor: Each individual is considered to be able to defend their honor by the honorable use of arms or magic. This type of activity is governed by a set of rules that differs substantially between commoners and nobles.

Medieval Society

The hierarchy of a medieval society is based upon title and rank within that society. The higher your rank, the more authority and respect you command.

In the NERO world, noble title is sometimes inherited and sometimes earned. Depending on circumstance, then, either the King or Queen could be the power. The husband or wife of the noble in power either has a decision making power equal to or just under that of the noble themselves (providing that person grants that power), or has little to do with governing at all, being just a figurehead.

Titles and Rankings

King/Queen

Theirs is the final word on all matters and is literally the law. Once the Royal mind is made up, it goes without question. They would be addressed as *Your Majesty* or *Your Royal Majesty*.

Crown Prince/Crown Princess

This is the eldest child of the monarch who will inherit the crown upon the death of the parent or whoever has been designated as heir apparent to the throne by the sovereign ruler. They are addressed as *Your Royal Highness*.

Prince/Princess

These are the children of the King and Queen who are not

designated heirs (usually all but the first born). They are addressed as *Your Highness*.

Duke/Duchess

This is a title of nobility inherited or granted by the King that earns respect and sovereignty over a portion of the King's lands (which can then be divided among Counts and/or Barons). They are addressed as *Your Grace*.

Count/Countess

This title is inherited or granted by a Duke or King and earns respect from Barons, Knights, guards, Lords and commoners. They have sovereignty over a portion of the King's lands which can then be divided among Barons. They are addressed as *My Lord Count* or *My Lady Countess*.

Viscount/Viscountess

This title is usually a title of honor given to a nobleperson. It does not carry any lands. They are addressed as *Your Excellency*.

Baron/Baroness

This title is inherited or granted by a Count, Duke, or King. It commands respect from commoners, guards, Knights, Lords, and has sovereignty over a portion of a Count's (or Duke's) lands. They are addressed as *My Lord Baron* or *My Lady Baroness*, or in some places as *Good Sir Baron* or *Good Dame Baroness*.

Seneschal

This is a title of someone who functions as the secretary to the holder of a noble title. He or she may perform justice or execute decisions in the name of their liege. In the absence of the liege, they have the power of the liege. They are granted estates, though often they reside on a portion of their liege's estate. They are addressed as *My Lord Seneschal* or *My Lady Seneschal*.

Knight

A Knight is a person granted the right to bear arms and distribute justice in the name of a liege or to carry the standard of their liege, and to own an estate. A Knight commands respect from other Knights, Lords/Ladies, guards, and commoners. Some knights are Paladins. These are the knights whose dedication to the Code of Chivalry is so great that their liege has given them this honorary title. Paladins have no special powers except when conducting trials of nobility. They are addressed as *Good Sir Knight* or *Good Dame Knight*.

Lord/Lady

A Lord or Lady is usually the spouse or child of a noble. They deserve respect as a noble but cannot perform any noble duties nor own an estate. In some places, a Lord or Lady is equivalent to a knight and can hold all of the same powers as a knight. They are addressed as *Your Lordship* or *Your Ladyship*.

Magistrate

Magistrates are granted the right to try commoners and dispense justice in the lands of their liege. They do not have the power to make laws nor do they have any power outside of their liege's

lands. Their decisions can be overruled by any noble of their liege's land, but such an act is usually extreme in nature and is subject to review. Although probably not noble, they are treated with respect due a noble and are addressed as *My Lord Magistrate* or *My Lady Magistrate*.

Guildmaster/Guildmistress

Though not a noble title, the head of a chartered Healers' Guild or Mages' Guild is often accorded the same respect as a knight. They are addressed as *Guildmaster* or *Guildmistress*.

Squire

A squire is a knight in training. Although they hold no power and are not considered nobility, they are treated with respect by guards and commoners. They are addressed as *Squire*.

Sheriff

The Sheriff is appointed by the Magistrate and is responsible for appointing and maintaining the Town Guard. They are addressed as *M'Lord M'Lady, or Sheriff*.

Guard

A guard is a person granted the right to uphold the laws and distribute settlements to minor disputes within the lands and laws of their immediate liege only. They would command respect from commoners. They are addressed as *M'Lord, M'Lady, or Guard*.

Merchant

A merchant is an upper class or wealthy commoner who may or may not be respected or paid attention to by the lower ranking nobles and Knights, but who would command the respect of the other commoners. Often they can be minor land owners if this is granted by their liege. They are addressed as *Good Merchant*, or *M' Lord* or *M'Lady*.

Common Townsfolk

These are people who live within a town, anyone from a tradesman to a clerk. They do not own land. They are addressed as *Goodman* or *Goodwife*.

Special Cases

Adventurer

While not quite the same status as common townsfolk, adventurers are nonetheless also not of rank equal to nobility. They are rarely land owners. They owe respect to anyone with the rank of guard or higher.

Mage

The mage is generally considered the same as a merchant (although his or her apprentice may not be), but unless they are appointed to or inherit a title, they are not nobility. If not in anyone's service, yet a member of a recognized guild, they should be accorded the same respect as a merchant. If acting on their own, they should be treated properly as any other commoner would be for the situation. For example, if this is reputed to be a powerful independent mage, "Begone wretch" may not be entirely appropriate.

Healer

Healers are treated like mages with appropriate respect due a member of the healing profession (in case you ever expect to be injured).

Thieves

Thieves are commoners unless someone has granted them a title of some sort. (We're sure the thieves out there will find plenty of ways to exact revenge for this obviously gross injustice. . .)

Noble Powers

Nobility carries with it power and responsibility. Beside showing respect to those who are above you in the feudal hierarchy, you must also obey them.

Commoners owe respect to nobles because nobles protect them from marauding monsters, ensure that there is a flowing economy, strengthen the land's ties with the throne, and generally maintain a status quo which keeps the citizenry a few steps away from anarchy. Because of all this hard work, if a noble gives a commoner an order, that person is obligated to obey it. Although there is no Oath of Fealty, the relation is implied because of what the noble does for the commoner.

Does that mean that the nobles have free reign over the commoners? Of course not. A noble who orders commoners to perform manual labor or pushes them about for no reason places himself or herself at risk of losing his or her title. The noble's lieges are obligated to investigate any charges of wrongdoing by the nobility even if reported to them by a commoner.

In some ways, squires fit into the same category as commoners except that they



have sworn an Oath of Fealty to a noble. That squire's oath is also sworn to any person the noble has an oath to as well. Therefore, if Squire Michael swears an oath to Dame Linda, he has implied oaths to Linda's liege, Baroness Jora, and to her liege, Duke Padsworth. And of course, all oaths are sworn to the King or Queen.

If someone higher than you on the chain of command gives you an order, you are required to obey it, provided that the order is not contradictory to orders already issued you by your liege.

Suppose Michael becomes a knight in Baroness Jora's court. If Baron Higgin comes along and gives Michael an order, does he have to obey it? Yes, but only if it is not contradictory to a previous order given by his liege Baroness Jora. This can be somewhat confusing and does present the same problems posed by nobles ordering commoners around, but it is also self-correcting in the same fashion.

If Baron Higgin orders Sir Michael to accompany him on a rescue mission, Michael must obey. If Baroness Jora had previously ordered him to await the arrival of a visiting dignitary then he could refuse to follow Baron Higgin's orders explaining, of course, that his liege had already given him an important task. If Baroness Jora had given him no specific task, then he would have to obey.

If Baron Higgin had ordered Sir Michael to kill a commoner standing nearby, he would also have to obey. Although no explanation was given, and this seems like a heinous crime, the knight would be required to follow the command.

Suppose the commoner was really an evil doppelganger. Baron Higgin's quick thinking would have saved the day. Had the knight argued with the Baron, the villain might have been able to escape.

By ordering someone to do something, a noble takes a great risk. If a noble gives an order, then that noble takes full responsibility for the results of that order.

In the example above, if the commoner proved to be nothing more than an ordinary citizen, Baron Higgin would be guilty of murder even though he himself did not perform the action, and Sir Michael would be found innocent. Baron Higgin would certainly lose his title and be subjected to the laws of the region as well.

Nobles understand that the power to command others must be used very carefully. Much thought must be given before issuing an order. This is why most nobles will not issue orders to those outside of their immediate court.

A good example of this chain of command can be found in the modern day army of nearly any country in the world. A private who is a member of Company D must still obey orders given to him or her from a sergeant from Company B. It is assumed that this power will not be abused or misused. While it's true that noble courts are not military organizations, they operate using a chain of command structure upon which modern day conventions are based.

This also applies to dispensing justice. Not every nobleperson can act as judge and jury in every instance. Generally speaking, you may only dispense justice upon those who are under you in the chain of command. A knight can only decide cases that result from actions taken on his or her lands. Visiting nobles should always defer to the owner or administrator of the local lands. This overlaps a bit of course: a knight's lands are also the lands of all of the knight's lieges.

Any person of any rank giving orders or dispensing justice among the commoners must be certain beforehand that their superiors would agree with both their reasoning and the severity of the



punishment. If they indiscriminately or falsely submit a commoner to punishment then their superiors should see to it that they receive punishment equal to that enacted against the person in question. There are consequences for every action.

To summarize, all commoners must obey nobles of any rank. Nobles must obey the orders of nobles of a higher rank than themselves provided those orders are not contradictory to the ones given them by their liege lord. It is incumbent on nobles to watch those under them to make sure this is not abused. In addition, nobles may dispense justice for crimes committed on their lands only.

General Courtesy

For the most part, showing respect for someone of a higher rank than yourself is very similar to showing respect for persons of importance in modern society. The average person on the street would not be able to walk in and start chatting with the President any more than your character should be able to chat with the King. Just like in modern society, in order to speak with any important person, you have to run through a lot of red tape.

For example: Say Amilio the Stout wanted an audience with the King because he thought the monsters just outside of his town were killing more than their fair share of townsfolk every Saturday night. He would, if following proper channels, take the case to a local Baronial guard or to the Baronial Seneschal if one was available. If



neither of these were available to listen to the problem, he could even try approaching one of the Baronial knights who may be willing to listen. Should our hero's pleas still go ignored or his request to speak to the King not considered important, he might consider taking his case to the local mage or healers' guild representative to plea his case for him. They might command more attention. That person would approach the Baron and request the Baron to listen to Amilio's problem. If the Baron listens, he may then elect to

- (1) *solve the problem himself;*
- (2) *offer to take the problem to the Duke himself;*
- (3) *decide that the problem is better left alone for now and thank Amilio for his concern; or*
- (4) *petition for an audience with his liege (probably a Count or Duke) on behalf of Amilio.*

If Amilio is the reasonable sort who speaks politely (and nicely), the Baron may recommend that Amilio present his case himself. At this point, Amilio may find himself talking to his Count (who may go through the same decision process) or may find himself with an audience with the Duke himself.

For the most part, no commoner will generally find themselves in an audience with the King unless the King is feeling generous. Adventurers and members of important guilds will be treated with slightly more respect than the average commoner in these situations.

As far as everyday courtesy goes, when a person of noble ranking passes you on the street and their rank is higher on the food chain than yours, you should bow slightly. If a contingent of guards or knights is coming down the road, you give them the right of way.

When addressing another person, and you are uncertain of their station or rank, you should address them as "M'Lord" or "M'Lady." This ensures that everyone receives at least common respect. More importantly, it adds to the atmosphere of the game as a whole.

Noble Etiquette

Among the nobility, many ranks give your character the right to dispense justice in accordance to the laws of the kingdom. This functions much like modern society where people of powerful political or business ranking are entitled to a show of decorum and some preference from society (although it certainly has never demanded that everyone like or never poke fun at these figures).

Noble ranking also requires from the noble people a certain amount of responsibility and adherence to the kingdom's laws

themselves from the noble. Each noble in turn is expected to answer to those to whom their station would require they pay deference. A cruel and unjust baroness who consistently imposes petty and unfair disciplines upon the commoners may eventually be subject to punishment by the same laws she used to abuse her people.

Now back to our friend Amilio. Amilio has been trying to get an audience with the Duke. He has been going through the proper channels and has been getting nowhere, mainly because Baron Wasteland (on whose lands Amilio lives) is a real creep. Amilio, in a fit of frustration, finally decides to take his case directly to Count Chermoney, Baron Wasteland's liege. Amilio pleads his case to the Count's seneschal or to one of the Count's guards. He will then get an audience with the Count and may tell him of the unreasonable attitude of Baron Wasteland. After dealing with Amilio's problem, Count Chermoney will then be responsible for dealing with the negligent and abusive attitudes of Baron Wasteland.

Should the Baron be found to have repeatedly treated his people in this manner and should continue to disobey the wishes of his liege, then the Baron faces the very real threat of being stripped of his lands and title and finding himself broke and in jail.

Becoming a Noble

Becoming a noble is a goal for many players in NERO. Nobility offers many in-game benefits: besides being in the middle of many important in-game events, you get real in-game power and in some chapters, an automatic income from your estates.

Because the position offers such benefits, it is not easy to obtain. To become a knight, you have to prove your worth through a series of tests and challenges. Take this point seriously! Simply showing up every event will not be enough; the position will not be granted for longevity.

Becoming a knight requires work. Put a lot of effort into your costume. Constantly be in character. Always be the "good guy" (at least in public). Earning a knighthood is a reward. It's a quest. It's not a right. NERO wants its players to respect you (the player) for all the hard work you have done to achieve that position even if they don't respect your character.

Bloodlines

Many societies and cultures in the NERO world care a great deal about bloodlines and lineage. In particular, many of the races of the world are concerned about interbreeding. However, with a millennia of interaction among the races, no PC member of a race can absolutely verify, through magical means or otherwise, the complete "purity" of their bloodline.

Index

Symbols

<Effect> Shiel 92

A

accept 47
Acid Traps 96
Activate 51
Activating Magic Items 51
Additional Effects and Attacks 90
Alarm 97
Alchemical Solvent 116
Alchemical Substances 115
Alchemy 33, 115
Alcohol 101
Alcohol Rule 5
Alternate Lock Picking 40
Amani elf 17
Antidote 117
Arcane 87, 90
Archery 14, 17, 43
Area of Effect 87
Armor 32, 105
Armor points 105
Armor Points 6, 12, 22, 80, 88, 105, 116
Arrows/Bolts 109
Assassinate 33, 76
Awaken 67, 68, 91
Axe 110

B

Back Attack 34
Backfire 97
backlash 52
Backlash 56, 58
Backstab 34
Bane 49, 52
Bane (Minor) 52
Banish 67
Barbarian 15
Barbarian Slay 14, 15, 34
Baseball Swing 86
Base Claws/Body Weaponry 90
Base Production 32
Batch 52
Berserk 48, 117
Biata 15
Bind 48
Blade Effects 47
Blade Fury 34, 35
Blade/Shaft 108
blanket 26
Bless 67
Bludgeon 110
Blunt Weapons: 106
Body Contact 5, 85

Body Points 6, 8, 12, 14, 16, 18, 19, 22, 23, 25, 26, 37, 39, 67, 68, 70, 79, 88, 91, 93, 94, 102, 116
Bow 109
Bows 19, 20, 43, 44, 107
Break Charm 14, 15, 34
Bucklers 86
Build Cheating 99
Build Points 6, 26

C

cabin assignment 6
Calling Hits 89
Calling Weapon Damage 87
Calm 67
Calm Animal 68
Camp Pad 111
Cantrip 37, 59, 60, 73, 76, 129
Cantrip Pages 59
Cantrip Tome 59
Carrying 23
Casting Spells 46
Cast on the Fly 46
Cause Critical Wounds 68
Cause Damage 117
Cause Disease 68
Cause Light Damage 117
Cause Light Wounds 68
Cause Mortal Wounds 68
Cause Serious Damage 117
Cause Serious Wounds 68
Cause Wounds 68
Celestial Abstinence 15
celestial magic 14, 15, 17
Celestial Magic Spell Slot 34
Chain Mail 106
character histories 9
Charging 85
Charm , 68
Charm Animal 69
Charm Effects 47
Cheating 99
Circle 24
Circle of Harmony 69
Circle of Power 37, 48, 69
Class 12
Cloak 49, 52
Cloak (Minor) 52
Closed Cell Foam 111
Code of Conduct 100
Combat 84
Components 50
Concentration 62
Confine 48, 70
Construction Materials 111
Contact 87
Contact poisons 116

Contact Poisons 32
Containers 98
Continuous 62
Control Undead 70, 90
Conversational Combat 89
Core 111
Corruption 70
costume 6, 18, 36
Costume Bonus 105
Count 9
Counted Actions 85
Craftsman 14, 34
Craftsman (other) 20
Create Potion 35
Create Scroll 35, 37
Create Trap 35
Create Traps 96
Create Undead 70
Creating Undead 54
Creation 53
Critical Attack 7, 29, 35
Critical Slay 35, 76
Critical Slay / Parry 35
Crossbow 109
Crossbows 19, 20, 43
Crossguard 108
Cultures 21
Cure Critical Wounds 71
Cure Disease 71
Cure Light Wounds 8, 71
Cure Mortal Wounds 71
Cure Serious Wounds 71
Cure Wounds 71
Curse 71
Curse of Transformation 23, 25, 90, 129

D

dagger 23
Dagger 110
Damage Amount 87
Damage Aura 53
Damage Cap 92
Damage Type 87
Dark Territory 52, 56, 57, 58
Dealing Damage(Traps) 98
Death 22, 71
Death Stone 25
Deformities 38
Delayed Endow 47, 71
Delimit 52
Delivery Methods 87
Desecrate 72
Destroy 72
Destroy Undead 72
Detect Celestial Magi 15
Detect Celestial Magic 14, 36
Detect Magic 72

Dexterity Armor 36
Disarm / Arm Trap 36
Disarm/Arm Trap 8, 19
Disarming Traps 98
Disease 48
Dispel Magic 68, 70, 72, 74, 75
Dispel Magic. 76
Displacement 73
Dodge 34, 39
Double from <damage type or effect> 92
Drae 16
Dragon's Breath 73
Drain 91
Dwarf 16
Dying 23

E

Earth Magic 20
Earth Magic Spell Slot 36
Effect: 88
Effects Types 87
Eldritch Blast 73
Eldritch Power 48
Elemental 87, 90
Elemental Blade 47, 73
Elemental Planes 48
Elemental Shield 73
Elemental Shield. 47
Elf 17
Elixirs 32, 115
Empathic Healing 73
Enchant 52
Enchanted Blade 47, 74
Endow 47, 74
Enflame 74
Enhanced Armor 42
enslavement 20
Enslavement 23, 25, 34, 41, 64, 67, 69, 70,
78, 80, 90, 92, 115, 116, 117, 130, 134
Enslavement Antidote 117
Evaluate Item 36
Evendarr 20
Expanded Enchantment 52
expendable 47
Experience Points 6, 26
Explosive Traps 97
Extended Circle of Power 53
Extended Circles of Power 50
Extended Earth Circle 24, 51
Extended Hearth 74
Extend Formal Magic 52

F

Fear 91
Feeblemind 48, 117
fighter 14
Fighter 12
fighters 18

Fire / Acid Traps 96
First Aid 10, 23, 30, 37, 38, 81, 93, 130
First Event Deaths 25
Fishtail 56
Flame Bolt 75
Flaw 56
Florentine 37
Focus 92
Forget elixir 15
Forget elixirs 17
Forget-it-Well 23, 78, 116, 117
Forget-It-Well 117
Forget-me-Not 23
Forget-Me-Not 117
Forget poison 24
Forget poisons 25
Formal Magic 37, 49, 50
Formal Magic Casting Walkthrough 57
Formal Magic Scroll 49
Formal magic Spell 49
Free Undead 75
Fumble 74

G

Gaffer Tape 112
Game Items 105
Game Money 94
Gaseous Form 92
Gases 116
Gas Globes 32
Gas Traps 97
Gate 94
Goblin 33, 130
Goblin Production 33
Golems 54
Got it 47
Greater Extension 52
Grip 108
gryphon 15
Guardian of the Four 75
Gypsy 18
Gypsy Code of Honor 18
Gypsy Curse 14, 18, 23, 25, 30, 37, 56, 75,
79, 87, 102

H

Half Ogre 18
Half Orc 19
Hallucinoid 48, 118
Hammer 110
Harmed by <damage type or effect> 93
Harm Undead 75
Hatchet 110
Head 108
Heal by <damage type or effect> 93
healers 17
Healing Arts 10, 24, 37, 38
Help Undead 75

Herbal Lore 39
Hit Points 22, 130
Hobling 19
Hobling Dodge 14, 19, 39
Hold 48, 84
Hold Rule 5
How to Make a Weapon 112
human 13

I

Identify 51
Illegal Skills and Powers 48
Illumination 75
Immune to/from <damage type or effect>
93
Immune to <Type> Weapons 93
Imprison 23, 48, 75
Improved Hearth 76
Improving a weapon 42
incantation 46
Incapacitated 23
indefinite 48
Indefinite 62
Indestructible 56
Infection 23, 25, 91, 130
Ingested 87
Inspiration 76
Instant 62
Intoxicant 118
Investiture, Lesser 76

J

Jewelry 94

K

Killing Blow 23, 24
king 9

L

Latex Weapons 106
Lay-on 84
LCO 53
Leather 106
Legal Targets 86
Lesser 91
Lesser Divestiture 76
Level 26
Life 2, 7, 22, 23, 24, 25, 35, 48, 49, 54, 63, 65,
67, 70, 71, 73, 76, 77, 79, 81, 91, 93, 117, 129,
130, 133, 134, 135
Lightning Bolt 77
Lightning Storm 77
Limited Reset 28
Line of Sight 62
Liquid Light 118
Local Chapter Only 53
Locks 96

M

Mace 110
Machine Gunning 86
Magic 46, 87, 90
Magic Armor 77
Magic Item 15, 51
Magic Items 94
Magic Item Slots 51
Magic Missile 77
Magic Storm 77
Maintaining Your NERO Weapon 114
Make Your own(Weapons) 108
Making weapons 42
Manifold 39, 62
Marshal 25, 52, 55, 56, 57, 58, 95, 96, 97, 98, 99, 100, 115, 116, 130
Massive 91
Massive Mechanical Traps 96
Master Critical Attack 40
Master Critical Slay 40
Master Parry 40
Master Proficiency 40
Materials 32
Medic 101
Meditate 47
Meditation 47
Memorization 46
Mentalist 15, 17
Metagaming 99
Mind Abilities 93
Mind Effect Restrictions 115
Monsters 21
Monster Size 22
Multiple Characters 8
Multiple Formal magic Spells Cast upon a Single Target 56
Mystic Lock 77
Mystic Wood Elf 20

N

Natural Armor 93
Nausea 48, 118
necromancy 10
Necromancy 48
Negating Attacks 89
NERO International 9
nobility 10
No effect 47, 93
Noise Makers 97
No Metabolism 93
Non-Corporeal Form 93
Non-Player Characters 7
NPC 21

O

Obliteration 49
Oil of Slipperiness 118

One Handed Block 44
One Handed Blunt 20, 31, 44
One Handed Edged 10, 28, 44
One Handed Sword 110
One Handed Weapon Master 44
Open Cell Foam 112
Opening Ceremonies 28
Out-of-Game 22, 130
Out Of Game 22

P

Packet 87
Packet Attacks 90
Page Status 101
Pantherghast 54
Paralyze 48, 77, 118
Paranoia 118
Parry 35
Paste of Stickiness 118
permanent death 53
Personality Changes 38
Phase 93
Physical 87, 90
Physical Armor 106
Physical Representations 105
Physical Strik 91
Picking Locks 98
Pick Locks 8, 14, 19, 40
Pin 48, 78
Pinning 85
Pipe foam Insulation 111
Plate 106
Plot Committee 9, 21, 22, 34
Poison 87, 90
Poison Shield 78, 118
Polearm 14, 44, 110
Polearms 16, 19
Pommel 109
Pool noodle 111
Potions 32, 114
Pre-made weapons 108
Prepare Hearth 39, 40, 76
Production 32
Protection Aura 52, 53
Purify Blood 68, 78
pyramid 28, 29, 47
Pyramid 53, 56

Q

Quentari elf 17
Quick Start Character Gen 102
quiver 110
Quiver: 109

R

Race 13
Rapid refit 42
Read and Write 9, 10, 14, 29, 40

Read Magic 14, 15, 16, 29, 41
Real Weapons 101
Reduced Damage 93
refit 36
Refit Armor 78
Refitting Physical Armor 106
Reflect Magic 78
refused 47
Regeneration 78, 93
Release 79
Remove Curse 79
Remove Drain 79
Remove Fear 79, 91
Remove Gypsy Curse 37
Remove Physical Affliction 79
Remove Weakness 79
Render Indestructible 52
Renew <option> 93
Repel 79
reset 28, 46
Resist 94
Resist Charm 14, 15, 16, 17, 20, 41, 91
Resist Charm. 68
Resist Poison 14, 16, 19, 20, 21, 30, 41, 90, 97, 102, 115, 116, 131
Resist Sleep 14, 15, 16, 17, 41
Restore Limbs 79
resurrected 8
Resurrection 24, 51
Return <type> 47, 94
Reversible Spells 48
Revive 93, 94
Rift 94
Rip from Pin/ Bind/Web/Confine 94
Rogue 12
role-play 15, 36
role-playing 13, 17

S

Safety 84, 101
safety tag 6
Sanctuary 79
Sap 110
Sarr 20
Scavenger 21
Scenting 14, 20, 21
Scholar 12
Scholarly skills 15
Scholarly Skills 14
Scholars 19
Schools of Magic 47
Scrolls 32, 115
Scroll Specific 53
search 8
Searching a Cabin 95
Searching a Person 95
Securing your Cabin 95

Setting off a Trap 97
Setting Traps 97
Shatter 47, 80
Shield 41, 80
Shield Bashing 86
Shield Magic 47, 68
Shields 86, 114
Shun 80
Shun Animal 80
Silence 48, 80
Silver Aura 47, 80
Silvering a weapon 42
slavery 20
Sleep 48, 80, 118
Small Weapon 20, 31, 37, 44
Smithing 14, 16, 42
Smoking 101
Sneaking Rule 6
Solidify 94
So You Want to Be a Thief 94
Spear 110
Spears: 107
Special Abilities 32, 89
Special Ability 42
Special Defenses and Vulnerabilities 92
Special Property 42
Spell 87
Spell Aura 46
Spell defenses 48
Spell Defenses 47, 62
Spell Disruption 46
Spell Durations 62
Spell Grounding 86
spell orb 46
spell packet 46
Spells 62
Spell Slot 28, 34
Spell Store 52, 53
Spell Strike 91
spirit 24
Spirit 22, 24, 49, 50, 52, 55, 60, 67, 71, 131
spirit-link 25
Spirit Lock 52
Sportsmanship 100
Stabalize 81
Stabilize 37
Stacked Effects 47
Staff 14, 44
Standard 111
Standard Reset 28
Staves 16, 19, 20, 110
Stealing an Item 94
Stealth Skills 14
Stone Bolt 81
Stone elf 17
Stop Thrust 42
Strapping Tape 112

Strengthening an item 42
Strong arm 14
Strong-arm 18, 43
Style Master 43
Success versus Failure 56
Suicide Ability 94
Summoning 53
Superhuman Strength 92
Swinging your weapon 86

T

Taint Blood 48, 81
Tapes 112
Target Effect Limits 55
Targets 56
Target Specific 47
Tarry 81
Templar 12
Thief 94
Threshold 94
Throwing/Tossing Items 89
Thrown Weapon 44
Thrown Weapons 20, 110
Thrusting Tip 108
Timed 62
times per day 47
Torches and Flames 101
Touch 87
Touch-Casting 46
Trade Mastery 32
Transform 53
Trap Mechanics 97
Trapping 85
Traps 32, 96
Trap Triggers 97
Trap Undead 75, 81
Turn Undead 81
Turtling 86
Two Handed Blunt 14, 16, 17, 19, 20, 31, 44, 102, 109
Two Handed Sword 14
Two Handed Sword 14, 44, 110
Two Handed Swords 16, 17, 19
Two Handed Weapon Master 44
Two handed weapons 107
Two Handed weapons 20
Two Weapons 43

U

Ultralight 111
Unconscious 22
Uncontrollable Action 38
Unparalyze 81
Unrestricted 53
Unskilled Weapon Use 86

V

Vampire Charm 92

Vengeance 50, 87
Vertigo 48, 118
Visible Effects 48
Vorpal Coating 118
Vorpal Coatings 116
Vulnerabilities 92

W

Ward 48, 82
Waylay 43
Weakness 82, 118
Weapon Blow 87
Weapon Combat 106
Weapon Construction 108
Weapon Master 43
Weapon Parts 108
Weapon Proficiencies 9, 35
Weapon Proficiency 29, 43
Weapons 32, 95, 106
Weapon Safety Checks 107
Weapon Safety Guidelines 110
Weapon Skills 43
Weapon Sock 112
Weapon Specific Specs 109
Weapon Tags 107
Weapon Traps 96
Weapon Type 87
Wear Bonuses 105
Wear Extra Armor 44
Wear Extra Armor: 105
wear point 36
Wear Points 105
wear point total 36
Wear Point total 105
Web 48, 82
Wild Elf 17
Wither Limb 47, 82
Wizard 49
Workshops 32, 33

X









XP 6, 26









<i>EFFECTS</i>										<i>DURATION</i>	<i>REVERSAL</i>
4	Desecrate		✓							Indefinite	Dispel Magic
6	Destroy	✓	✓	✓						Instant	
7	Destroy Undead		✓							Instant	
2	Detect Magic	✓	✓	✓						Instant	
8	Dispel Magic	✓	✓	✓	✓	✓				Instant	
8	Displacement	✓								Indefinite	Dispel Magic
8	Dragon's Breath	✓		✓						Instant	
X	Drain									5 Minutes	Remove Drain, Life
X	Drain Life									5 Minutes	Life
9	Eldritch Blast	✓								Instant	
4	Elemental Blade	✓		✓		✓				Indefinite	Dispel Magic
6	Elemental Shield	✓	✓	✓	✓	✓				Indefinite	Dispel Magic
2	Empathic Healing		✓							Instant	
6	Enchanted Blade	✓		✓		✓				Indefinite	Dispel Magic
1	Endow	✓		✓		✓				Indefinite	Dispel Magic
6	Enflame	✓								Instant /5 Sec	Dispel Magic
X	Enslavement							✓		Indefinite	Enslavement Antidote
10	Enslavement Antidote							✓		Instant	
7	Extended Hearth	✓	✓							Indefinite	Destroy Formal Magic
X	Fear									Line of Sight/ 5 Minutes	Awaken, Remove Fear
6	Feeblemind							✓	✓	5 Minutes	Antidote, Purify Blood
10	Forget-It-Well							✓		Indefinite	Antidote (Ingested), Purify Blood (10 min window)
7	Forget-Me-Not							✓		Indefinite	Antidote (Ingested), Purify Blood (10 min window)
4	Flame Bolt	✓		✓						Instant	
1	Free Undead		✓							Instant	
1	Fumble	✓	✓	✓						5 Seconds	Dispel Magic
7	Guardian of the Four	✓		✓		✓				Indefinite	Dispel Magic
2	Hallucinoid							✓		5 Minutes	
3	Harm Undead		✓							Instant	
3	Help Undead		✓							Instant	
3	Ice Bolt	✓		✓						Instant	
7	Ice Storm	✓		✓						Instant	
9	Imprison	✓								10 Minutes	Dispel Magic
1	Illumination	✓	✓							5 Days	Dispel Magic
1	Improved Hearth	✓	✓							1 Hour	Dispel Magic

* An effect costs 1 level more as a gas than the level listed.

** Reversal depends on delivery method

EFFECTS	C	E	S	P	M	C	E	G	DURATION	REVERSAL
2 Alchemical Solvent						✓			Instant	
2 Antidote (Contact)							✓		Instant	
4 Antidote (Gas)							✓		Instant	
5 Antidote (Ingested)							✓		Instant	
10 Berserk							✓		5 Minutes	Antidote, Purify Blood
4 Awaken	✓	✓	✓	✓	✓				Instant	
9 Banish	✓	✓							Instant	
4 Bind	✓	✓	✓						Line of Sight	Release, Dispel Magic
1 Bless		✓		✓					Indefinite	Dispel Magic
4 Calm	✓	✓							5 Minutes	Awaken, Dispel Magic
1 Calm Animal		✓							5 Minutes	Awaken, Dispel Magic
6 Cause Critical Wounds / Damage		✓		✓	✓		✓	✓	Instant	
3 Cause Disease		✓		✓	✓				Indefinite	Cure Disease, Dispel Magic
1 Cause Light Wounds/Damage		✓		✓	✓		✓	✓	Instant	
8 Cause Mortal Wounds / Damage		✓		✓	✓		✓	✓	Instant	
4 Cause Serious Wounds / Damage		✓		✓	✓		✓	✓	Instant	
2 Cause Wounds / Damage		✓		✓	✓		✓	✓	Instant	
7 Charm	✓	✓						✓	5 Minutes	Awaken, Dispel Magic**, Antidote**, Purify Blood**
3 Charm Animal		✓							5 Minutes	Awaken, Dispel Magic
6 Circle of Harmony	✓	✓							1 Hour	Dispel Magic
9 Circle of Power	✓	✓							10 Minutes	Destroy Formal Magic
8 Confine	✓	✓							Line of Sight	Release, Dispel Magic
2 Control Undead		✓							5 Minutes	Dispel Magic
8 Corruption		✓							1 Minute	Dispel Magic
7 Create Undead		✓							5 Minutes	
6 Cure Critical Wounds		✓		✓	✓				Instant	
3 Cure Disease		✓		✓	✓				Instant	
1 Cure Light Wounds / Damage		✓		✓	✓		✓		Instant	
8 Cure Mortal Wounds		✓		✓	✓				Instant	
4 Cure Serious Wounds		✓		✓	✓				Instant	
2 Cure Wounds		✓		✓	✓				Instant	
7 Curse		✓		✓					Indefinite	Remove Curse, Dispel Magic
9 Death		✓					✓		Instant	Life
2 Delayed Endow	✓		✓		✓				Indefinite	Dispel Magic

	<i>EFFECTS</i>									<i>DURATION</i>	<i>REVERSAL</i>
9	Inspiration		✓							Instant	
1	Intoxicant							✓		5 Minutes	Antidote (Ingested), Purify Blood
7	Lesser Divestiture	✓								Instant	
7	Lesser Investiture	✓								5 Days	
9	Life		✓							Instant	
2	Lightning Bolt	✓		✓						Instant	
6	Lightning Storm	✓								Instant	
1	Liquid Light						✓				
2	Magic Armor	✓	✓	✓	✓	✓				Indefinite	
1	Magic Missile	✓		✓						Instant	
9	Magic Storm	✓								Concentration	
7	Mystic Lock	✓								5 Days	Destroy Formal Magic
5	Nausea						✓	✓		5 Minutes	Antidote, Purify Blood
5	Oil of Slipperiness					✓				1 hour	Paste of Stickiness
8	Paralyze		✓				✓	✓		5 Minutes	Dispel Magic**, Antidote**, Purify Blood**
2	Paranoia						✓	✓		5 Minutes	Antidote, Purify Blood
5	Paste of Stickiness									1 hour	Oil of Slipperiness
2	Pin	✓	✓	✓						Line of Sight	Release, Dispel Magic**
4	Poison Shield		✓			✓		✓		Indefinite	Dispel Magic
5	Purify Blood		✓		✓	✓				Instant	
3	Refit Armor	✓				✓				Instant	
8	Reflect Magic	✓	✓	✓	✓	✓				Indefinite	Dispel Magic
8	Regeneration		✓							1 Minute	Dispel Magic
5	Release	✓	✓	✓	✓	✓				Instant	
7	Remove Curse		✓		✓	✓				Instant	
7	Remove Drain		✓		✓					Instant	
4	Remove Fear	✓	✓							Continuous	
6	Remove Physical Affliction		✓		✓	✓				Instant	
3	Remove Weakness		✓		✓	✓				Instant	
2	Repel	✓	✓	✓						Concentration	Dispel Magic
7	Restore Limbs		✓		✓	✓				Instant	
4	Sanctuary		✓							Indefinite	
3	Shatter	✓	✓	✓						Instant	
1	Shield	✓		✓		✓				Indefinite	Dispel Magic
5	Shield Magic	✓	✓	✓	✓	✓				Indefinite	Dispel Magic
4	Shun		✓	✓						Line of Sight	Awaken, Dispel Magic

EFFECTS		 C	 E	 S	 P	 M	 C	 E	 G	DURATION	REVERSAL
1	Shun Animal		✓							5 Minutes	Awaken, Dispel Magic
5	Silence	✓	✓							5 Minutes	Awaken, Dispel Magic
5	Silver Aura	✓		✓		✓				Indefinite	Dispel Magic
6	Sleep	✓	✓	✓	✓			✓	✓	5 Minutes	Awaken, Dispel Magic
1	Stabilize		✓							Continuous	
5	Stone Bolt	✓		✓						Instant	
5	Taint Blood		✓		✓					Indefinite	Purify Blood, Dispel Magic
7	Tarry		✓							5 Minutes	
1	Trap Undead		✓							Line of Sight	Free Undead, Dispel Magic
2	Turn Undead		✓							5 Minutes	Free Undead, Dispel Magic
8	Unparalyze		✓		✓	✓				Instant	
5	Vertigo							✓	✓	5 Minutes	Antidote, Purify Blood
1	Vorpal Coating 1						✓			5 Minutes	
3	Vorpal Coating 3						✓			5 Minutes	
5	Vorpal Coating 5						✓			5 Minutes	
9	Ward	✓								5 days	Destroy Formal Magic
3	Weakness		✓		✓			✓	✓	Indefinite	Remove Weakness, Dispel Magic**, Antidote**, Purify Blood**
5	Web	✓	✓	✓						Line of Sight	Release, Dispel Magic
7	Wither Limb		✓		✓					Indefinite	Restore Limbs, Dispel Magic
X	Vampire Charm									5 Minutes	Awaken

Stat cards for Create Undead

zombie (created by create undead spell)

Type: Undead	APL: 1	Physical Description: Same as in life
Body: PC Stats	Armor: Based on PC	
Strength: 0	Threshold: None	Motivation: Obey creator
At 0 Body: Remains	Protectives:	Int: Mindless
Rips from: None		Society: None
PC Levels: Yes		EarthSpells:
<input type="checkbox"/> Killing Blow Active	<input type="checkbox"/> Search & Steal	<input type="checkbox"/> Ensure Res.
		<input type="text"/>
		<input type="text"/>
Weapons: Based on PC Skills	Claws: None	
Small: "1 Normal"	<input type="text"/>	
1 Hand: "2 Normal"		
2 Hand: "3 Normal"		
Healed by:	Weapon Calls that affect:	
Necromancy	All	
Immunities:	Vulnerabilities:	
Poisons Calm, Charm, Death, Life, Paralyze, Shun, Sleep, Taint Blood, Cause Disease, Waylay	Spells vs Undead, Damage from healing	
Offensive Abilities:	Defensive Abilities:	
<input type="text"/>	<input type="text"/>	

zombie (created by create undead spell)

Type: Undead	APL: 1	Physical Description: Same as in life
Body: PC Stats	Armor: Based on PC	
Strength: 0	Threshold: None	Motivation: Obey creator
At 0 Body: Remains	Protectives:	Int: Mindless
Rips from: None		Society: None
PC Levels: Yes		EarthSpells:
<input type="checkbox"/> Killing Blow Active	<input type="checkbox"/> Search & Steal	<input type="checkbox"/> Ensure Res.
		<input type="text"/>
		<input type="text"/>
Weapons: Based on PC Skills	Claws: None	
Small: "1 Normal"	<input type="text"/>	
1 Hand: "2 Normal"		
2 Hand: "3 Normal"		
Healed by:	Weapon Calls that affect:	
Necromancy	All	
Immunities:	Vulnerabilities:	
Poisons Calm, Charm, Death, Life, Paralyze, Shun, Sleep, Taint Blood, Cause Disease, Waylay	Spells vs Undead, Damage from healing	
Offensive Abilities:	Defensive Abilities:	
<input type="text"/>	<input type="text"/>	



NERO®
Live Action Role-Playing

ISBN 978-0970056311 -3
53995 >
9 780970 056313